

# iTero Lumina™ intraoral scanner

User manual



it starts with iTero™



**Copyright**

© 2025 Align Technology, Inc. All rights reserved.

The information contained in this manual is subject to change without notice.

The hardware and software described in this manual are supplied under an iTero Purchase Agreement and Service Plan and may be used only in accordance with the terms of that agreement.

No part of this manual may be reproduced, photocopied, stored in a retrieval system, or transmitted in any manner (electronic or mechanical) for any purpose other than the customer's normal usage, without the prior written permission of Align Technology.

English language version

PN 216257 Rev. F  
Updated March 2025

**Patents**

[www.aligntech.com/patents](http://www.aligntech.com/patents)

**Trademarks**

Align, Invisalign, ClinCheck, iTero and iTero Lumina among others, are trademarks and/or service marks of Align Technology, Inc. or one of its subsidiaries or affiliated companies and may be registered in the U.S. and/or other countries.

Any other trademarks or registered trademarks appearing in this manual are the property of their respective owners.

**Global headquarters****Align Technology, Inc.**

410 North Scottsdale Road,  
Suite 1300, Tempe,  
Arizona 85281,  
USA

[www.aligntech.com](http://www.aligntech.com)

Tel: +1 (408) 470-1000  
Fax: +1 (408) 470-1010

**Customer Support**

Tel: +1 (800) 577-8767  
E-mail: [iterosupport@aligntech.com](mailto:iterosupport@aligntech.com)

**Align Technology Ltd.**

1 Yitzhak Rabin Rd.,  
Petach Tikva, 4925110,  
Israel

Tel: +972 (3) 634-1441  
Fax: +972 (3) 634-1440

**Align Technology B.V.**

Herikerbergweg 312  
1101 CT, Amsterdam  
The Netherlands

**UK responsible person:****Align Technology UK Ltd.**

2800 The Crescent, Solihull Parkway,  
Birmingham Business Park, Solihull,  
B37 7YL, England, United Kingdom

## Contraindications

For persons who have been diagnosed with Epilepsy, there is a risk of epileptic seizure from the flashing light of the iTero scanner.

## Compliance

### EMC compliance

This device complies with the following EMC standard:

IEC 60601-1-2 Medical electrical equipment - Part 1-2: General requirements for basic safety and essential performance - Collateral standard: Electromagnetic phenomena - Requirements and tests.

### Class 1 laser product compliance

This device complies with 21 CFR 1040.10 and IEC 60825-1.



### FCC compliance

This device complies with Part 15 of FCC Rules and its operation is subject to the following two conditions:

1. This device may not cause harmful interference.
2. This device must accept any interference received, including interference that may cause undesired operation.



### FCC warning

Modifications to the device that are not expressly approved by the manufacturer may void your authority to operate the device under FCC Rules.

### RCM and R-NZ compliance

This device complies with Australian RCM and New Zealand Radio Label requirements.



### Safety compliance

This device complies with the following safety standards:

- IEC 60601-1: Medical Electrical Equipment – General Requirements for Safety
- IEC 60601-1-6: Medical electrical equipment – Part 1-6: General requirements for safety – Collateral standard: Usability
- IEC 80601-2-60: Medical electrical equipment – Part 2-60: Particular requirements for the basic safety and essential performance of dental equipment
- IEC 60825-1: Safety of laser products – Part 1: Equipment classification, requirements and user's guide
- IEC 62471: Photobiological safety of lamps and lamp systems

### CSA compliance

This device complies with CSA standards.

This marking means that the product is certified for both the U.S. and Canadian markets, to the applicable U.S. and Canadian standards.



### CE compliance

This device complies with Council Regulations (EU) 2017/745 for Medical Devices.









## Nature of emitted scanner radiation

- **Electromagnetic radiation** - When used as directed, the iTero scanner's level of electromagnetic radiation is similar to that of a personal computer.
- **Laser and LED radiation** - The iTero scanner is classified as a Class 1 Laser product and as Group 1 for LED radiation.







## Symbols









The following symbols may appear on iTero Lumina hardware components and may appear within this document and other iTero Lumina literature.





Symbol	Symbol Name	Symbol Description	Standard Number and Name	Symbol Reference Number
	Refer to instruction manual/booklet	To signify that the instruction manual/booklet must be read before using this device.	ISO 7010  Graphical symbols - Safety colours and safety signs - Registered safety signs.	M002
	Type B applied part	To identify a type B applied part complying with IEC 60601-1.	IEC 60417  Graphical symbols for use on equipment.	5840
	Do not re-use	Indicates a medical device that is intended for one single use only.	EN/ISO 15223-1*	5.4.2
	Batch code	Indicates the manufacturer's batch code so that the batch or lot can be identified.	EN/ISO 15223-1*	5.1.5



Symbol	Symbol Name	Symbol Description	Standard Number and Name	Symbol Reference Number
	Waste electrical and electronic equipment (WEEE)	<p>Separate collection of electrical waste and electronic equipment is required. In compliance with the European Directive on Waste Electrical and Electronic Equipment (WEEE), do not dispose of this product in domestic or municipal waste. This device contains WEEE materials.</p> <p>Please contact your local Customer Support to arrange scanner collection.</p>	<p>EN 50419</p> <p>Marking of electrical and electronic equipment (EEE) in respect to separate collection of waste EEE (WEEE).</p>	N/A
	Caution	<p>Indicates that caution is necessary when operating the device or control close to where the symbol is placed, or that the current situation needs operator awareness or operator action in order to avoid undesirable consequences.</p>	EN/ISO 15223-1*	5.4.4
	Atmospheric pressure limitation	<p>Indicates the range of atmospheric pressure to which the medical device can be safely exposed.</p>	EN/ISO 15223-1*	5.3.9

Symbol	Symbol Name	Symbol Description	Standard Number and Name	Symbol Reference Number
	Humidity limitation	Indicates the range of humidity to which the medical device can be safely exposed.	EN/ISO 15223-1*	5.3.8
	Fragile, handle with care	Indicates a medical device that can be broken or damaged if not handled carefully.	EN/ISO 15223-1*	5.3.1
	This way up	To indicate correct upright position of the transport package.	ISO 7000 Graphical symbols for use on equipment Registered symbols	0623
	Direct current	To indicate on the rating plate that the equipment is suitable for direct current (DC) only.	IEC 60417 Graphical symbols for use on equipment.	5031
	Wand	Scanning unit.	N/A	N/A
	Unique device identifier	Indicates a carrier that contains unique device identifier information.	EN/ISO 15223-1*	5.7.10
	Country of manufacture (including date of manufacture)	To identify the country of manufacture of products.  The date of manufacture is located adjacent to the symbol.	EN/ISO 15223-1*	5.1.11

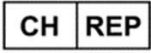
Symbol	Symbol Name	Symbol Description	Standard Number and Name	Symbol Reference Number
	Keep away from sunlight	Indicates a medical device that needs protection from light sources.	EN/ISO 15223-1*	5.3.2
	Prescription device	<b>CAUTION:</b> Rx Only. US Federal Law restricts this device to sale by or on the order of a licensed Dentist, Orthodontist, or Dental Professional. The system serves as a prescription medical device and should be operated by trained dental health-care providers only.	21 CFR 801.15(c)(1)(i)F	Labeling - Medical devices; prominence of required label statements; use of symbols in labeling.
	Manufacturer	Indicates the medical device manufacturer.	EN/ISO 15223-1*	5.1.1
	Catalogue number	Indicates the manufacturer's catalogue number so that the medical device can be identified.	EN/ISO 15223-1*	5.1.6
	Serial number	Indicates the manufacturer's serial number so that a specific medical device can be identified.	EN/ISO 15223-1*	5.1.7
	Alternating current.	To indicate on the rating plate that the equipment is suitable for use on alternating current (AC) only.	IEC 60417 Graphical symbols for use on equipment.	5032

Symbol	Symbol Name	Symbol Description	Standard Number and Name	Symbol Reference Number
	Keep dry	Indicates a medical device that needs to be protected from moisture.	EN/ISO 15223-1*	5.3.4
	Temperature limit	Indicates the temperature limits to which the medical device can be safely exposed.	EN/ISO 15223-1*	5.3.7
	Medical device	Indicates the item is a medical device.	EN/ISO 15223-1*	5.7.7
	Consult instructions for use or consult electronic instructions for use	Indicates the need for the user to consult the instructions for use.	EN/ISO 15223-1*	5.4.3
	Universal Serial Bus (USB), port/plug	To identify a USB port.	ISO 7000 Graphical symbols for use on equipment - Registered symbols.	3650
	Battery	To identify the location of the panel PC battery.	N/A	N/A
	Stand-by	To identify the power on/standby push button.	IEC 60417 Graphical symbols for use on equipment.	5009
	Use-by date	Indicates the date after which the medical device is not to be used.	EN/ISO 15223-1*	5.1.4

Symbol	Symbol Name	Symbol Description	Standard Number and Name	Symbol Reference Number
	Warning; Laser beam	To warn of a laser beam.  Class 1 laser product.	EN/ISO 7010  Graphical symbols - Safety colours and safety signs - Registered safety signs.	W004
	Importer	Indicates the entity importing the medical device into the locale.	EN/ISO 15223-1*	5.1.8
	Swiss authorized representative	Indicates the authorized representative in Switzerland.	MU600_00_016 version 5.0 Obligations Economic Operators CH.	N/A
	RoHS compliant for China	Indicates the electrical product contains certain hazardous substances and can be used safely during the environmental protection use period of 10 years and should be recycled after its environmental protection use period comes to an end.	SJ/T 11364  Marking for the restriction of the use of hazardous substances in electrical and electronic products.	N/A
	CE marking/CE marking of conformity	Indicates that a device is in conformity with the applicable requirements set out in EU MDR 2017/745 regulation and other applicable Union harmonisation legislation providing for its affixing.	Regulation (EU) 2017/745 of the European parliament and of the council of 5 April 2017 on medical devices.	Annex V of EU MDR 2017/745

Symbol	Symbol Name	Symbol Description	Standard Number and Name	Symbol Reference Number
	Authorized representative in the European Community/European Union	Indicates the authorized representative in the European Community/European Union.	EN/ISO 15223-1*	5.1.2
	Regulatory Compliance Mark (RCM)	Australian RCM label	AS/NZS 4417.1:2012 Regulatory Compliance Mark For Electrical And Electronic Equipment	N/A
	R-NZ mark	New Zealand Radio label	Radiocommunications (Compliance) Notice 2020	N/A

\***Glossary References:** EN/ISO 15223-1 Medical devices - Symbols to be used with medical devices labels, labeling, and information to be supplied - Part 1: General requirements.



## Safety instructions

Before using the system, all users are required to read and understand these safety instructions.

### Laser and LED safety

- The iTero Lumina wand is classified as a class 1 laser product per IEC 60825-1, Safety of laser products, and Group 1 per IEC 62471, Photobiological safety of lamp and lamp systems (LED).
- **Warning:** Avoid eye contact with the laser beam or the flickering white LED emission. Eye contact could cause damage to the eyes.
- **Warning:** Avoid activating the wand while the tip of the wand is outside the patient's mouth, in order to reduce the risk of eye damage.
- **Warning:** In order to prevent eye contact:
  - Avoid shining the wand directly into anyone's eyes.
  - Avoid activating the wand while the tip of the wand is outside the patient's mouth.
  - Avoid placing the wand in the cradle while the scanning operation is still active.
  - Place the wand in the cradle with the optical window facing the cradle.
- For additional protection, it is recommended that children wear protective eyewear during scanning procedures.
- The wand emits blue laser light (450nm Class 1), green laser light (520nm Class 1), as well as white LED emissions. Avoid shining the wand directly into anyone's eyes.

### Power supply

Power is supplied to the system via a medical-grade power supply. In iTero Lumina cart-configuration scanners, the power supply is enclosed in the base of the wheel stand. In iTero Lumina mobile-configuration scanners, the power supply is external.

### Battery power

- Charging – the scanner battery will be fully charged after being plugged into a power source for 2.5 hours.
- A fully-charged battery supports a total of 30 minutes scanning using the cart-configuration scanner, or 10 minutes using the mobile-configuration scanner.  
Cart-configuration scanners are provided with two Li-ion rechargeable battery packs. Mobile-configuration scanners are provided with one battery pack. The battery packs are placed in the back bottom half of the computing unit.  
**CAUTION:** There is a danger of battery burning and/or explosion if the screen is damaged and/or the battery is not replaced according to Align's instructions. Do not use the scanner if dropped or any damage is noticed. Contact Customer Support.
- Use only the original AC/DC adaptor connected to the system to charge the batteries.
- **CAUTION:** A failing Li-ion battery begins to hiss, bulge, and leak electrolytes. The electrolytes consist of lithium salt in an organic solvent (lithium hexafluorophosphate), which is highly flammable. Burning electrolytes can ignite combustible materials in close proximity.

Please note, there is a risk of burns associated with this situation.

- The screen should be stored and operated following the environmental conditions that appear in this manual. Do not expose the scanner to extreme heat sources, such as radiators and fireplaces.
  - Never operate the device without batteries! Do not use the batteries for any purpose other than the intended use of the product. Discard used batteries according to the manufacturer's instructions and local requirements.
  - Replace the batteries only with batteries supplied by Align for your specific device configuration.
- Electric warnings**
- **Warning:** Do not remove external panels and covers in order to avoid electrical shock. There are no user-serviceable parts inside. In iTero Lumina scanners, you may open the cover of the diagnostics panel in case of system failure, only when required by Customer Support.
  - **Warning:** Do not connect any non-Align-approved external devices such as webcams, USB devices, LAN, or other mains-operated equipment, in order to avoid electrical shock.
  - **Warning:** Do not remove and replace batteries without first disconnecting the power cable from the mains, and disconnecting the screen power cable.
  - **Warning:** Do not connect the scanner to a mains supply without protective grounding, in order to avoid the risk of electrical shock.
  - **Warning:** Use only the supplied power cable, which has a protective earth lead. Do not connect a power cable that is not supplied by Align Technology and/or do not use a power strip or extension cord to connect to the system in order to avoid electrical shock.
- Wireless LAN**
- The system comes equipped with a wireless LAN unit.
  - **Warning:** Never connect the LAN cable to the scanner, to avoid electrical shock.
  - When using the product, maintain a separation distance of at least 20cm between the computing unit and all persons' bodies to ensure compliance with RF exposure requirements.
- Safety classifications**
- Type of protection against electrical shock: Class 1.
  - Type of applied part: Type B.
  - Degree of protection against harmful ingress of water: Ordinary.
  - Equipment not suitable for use in the presence of flammable anesthetic mixtures.
  - Mode of operation: Continuous.
- Prescription health device**
- The system serves as a prescription medical device and should be operated by trained dental health-care providers only.
- Scanner warnings**
- **Warning:** When the system is not in use, the wand should be placed in the cradle with the optical window facing the cradle.
  - **Warning:** Avoid using the wand without a disposable sleeve in order to reduce the risk of cross-contamination, discomfort, and even burns.
  - **CAUTION:** Avoid twisting, knotting, pulling, and stepping on the wand cable and the power cable.

- **Warning:** Do not use the equipment if a scanner malfunction occurs or if physical damage is observed, in order to avoid electrical shock or physical injury. As soon as any damage is observed, stop scanning immediately, disconnect the system from the electricity, and call Customer Support.
- **Warning:** Do not clean, disinfect, or use the wand if any damage is found. Please contact iTero Customer Support for further instructions.
- **Warning:** Do not use the wand if any damage is found on the optical surface. Please contact iTero Customer Support for further instructions.
- **Warning:** Do not use the wand if any damage is detected. Please contact iTero Support for further instructions.
- **CAUTION:** Do not use the cradle if any damage is detected. Please contact iTero Customer Support for further instructions.
- **CAUTION:** Do not clean, disinfect, or use the cradle if any damage is detected. Please contact iTero Customer Support for further instructions.
- **CAUTION:** Do not use the scanner screen if any damage is found. Please contact iTero Customer Support for further instructions.

## Cleaning & disinfection

In order to reduce the risk of cross-contamination, it is mandatory to adhere to the following:

- Thoroughly clean and disinfect the wand, cradle, and other system components according to the instructions provided in [Care and maintenance](#), before first use and immediately after each use. Apply a new sleeve before each patient, as described in [Applying a sleeve](#).
- **Warning:** When disinfecting the wand, cradle, and other system components, use multiple fresh wipes, as necessary, to keep the system component surfaces wet for the full contact time, as recommended by the applicable disinfection wipes manufacturer.
- **Warning:** Avoid deviating from the recommended cleaning and disinfection process, and modifying or substituting recommended materials to reduce the risk of biological hazards.
- Disinfect the touch screen immediately after each patient.
- **Warning:** Remove and replace gloves after each patient session. Discard torn, contaminated, or removed gloves.
- **Warning:** Replace the iTero Lumina sleeve between each patient. Failing to replace the sleeve between patients may cause the inadvertent transfer of microorganisms and other contaminants from one patient to another.
- A new iTero Lumina sleeve or the protective sleeve may be applied to the wand after cleaning and disinfection have been performed.

**Unpacking & installing**

The system should be unpacked and installed following Align Technology's instructions, described in [Assembly instructions](#).

**CAUTION:** Contact Customer Support if the scanner box is damaged or if the ShockDot indicator on the box has been activated. Do not unpack the scanner.

**Notes:**

- Only an Align-provided webcam may be connected via the USB port, for training purposes.
- The webcam must be disconnected after each training session.
- The webcam lens should be covered when the webcam is not actively in use.

**Work environment**

- **Warning:** The system should be moved between rooms with utmost care to avoid damage.
- **CAUTION:** Do not cover/block the air vents on the wand and the computing unit.
- The system is intended for indoor use only. It should not be exposed to direct sunlight, excessive heat, or humidity.
- If the system has just been brought into the office from a hot, cold, or humid environment, it should be set aside until it has adjusted to room temperature, to avoid internal condensation.

**Electromagnetic interference precaution**

The device with its scanner sleeve has been tested and found to comply with the requirements for medical devices according to standard IEC60601-1-2. This standard is designed to provide reasonable protection against harmful electromagnetic interference and immunity in a typical clinic electromagnetic environment. Do not connect the device to any external devices or accessories during clinical use, including the webcam.

Avoid placing this device near frequency transmitting equipment including wireless products or other sources of electrical and electromagnetic interference (e.g. 5G cellular/cellular phones, mobile two-way radios, electrical appliances, RFID, MRI, diathermy, electrocautery, wireless power transfer (WPT)). High levels of such interference, due to close proximity or strength of the source, may result in disruption of performance of this device. In this case, the device can be returned to operation mode after user intervention or by auto-recovery.

Maintain minimal separation distance in accordance with the recommended separation distances between portable and mobile RF communications equipment and the iTero Lumina intraoral scanner and following the separation table detailed in [Recommended Separation Distances Between Portable and Mobile RF Communications Equipment and the iTero Lumina Intraoral scanner that is not Life-Supporting](#).

**Warning:** Keep the wand's cradle 6 inches (15 cm) away from magnetically susceptible medical devices such as cochlear implants, neurostimulators, stents and shunts.

**General****Notes:**

- Do not make any modifications to this equipment.
- Use only on patients who are able to comply with directions.
- Cart configuration only: Do not remove the computing unit from the stand after assembly.

- Follow the instructions to store the wand (probe) tip under proper conditions, as described in [Storage and maintenance](#).
- Follow the instructions to properly clean and disinfect the device, as described in [Care and maintenance](#).
- Follow the instructions to properly maintain and handle the instrument in the specified manner and condition, as described in [Care and maintenance](#).
- Do not connect any non-Align-approved external devices such as webcams, USB devices, LAN, or other mains-operated equipment.

#### Incident notification

Any serious incidents in relation to the iTero device should be reported to Align Technology Ltd. and the competent authority of the Member State in which the user and patient are established.

#### iTero Lumina sleeves

- **Warning:** The iTero Lumina sleeves are intended for single use only. Do not reuse.
- **Warning:** The iTero Lumina sleeves are intended for single use and must be disposed of and replaced after each patient in order to reduce the risk of cross-contamination.
- **Warning:** To reduce the risk of cross-contamination, it is essential that the iTero Lumina scanner is fully cleaned and disinfected immediately after each patient, and that the iTero Lumina sleeve is replaced between patients, as described in [Applying a sleeve](#).
- **CAUTION:** Do not use the iTero Lumina sleeves after the expiry date.
- **Warning:** If you notice any damage, do not use the iTero Lumina sleeves and contact Customer Support.
- iTero Lumina sleeves are supplied as non-sterile and should **not** be sterilized before usage.
- iTero Lumina sleeves comply with the applicable parts of ISO 10993 Biocompatibility international standard.
- **CAUTION:** Dispose of iTero Lumina sleeves according to standard operating procedures or local regulations for disposal of contaminated waste.

## Contre-indications – French

Pour les personnes souffrant d'épilepsie, la lumière clignotante du scanner iTero peut engendrer un risque de choc épileptique.

## Conformité – French

### Conformité CEM

Cet appareil est conforme à la norme CEM suivante :

CEI 60601-1-2 Appareil médical électrique -  
Section 1-2 : Exigences générales pour la sécurité de base et les performances essentielles - Norme collatérale : Phénomènes électromagnétiques - Exigences et essais.

### Conformité du produit laser de classe 1

Cet appareil est conforme aux normes 21 CFR 1040.10 et CEI 60825-1.



Class 1 Laser Product

### Conformité FCC

Cet équipement est conforme à la section 15 des règles la FCC. Son fonctionnement est soumis aux deux conditions suivantes :

1. Cet appareil ne doit causer aucune interférence nuisible.
2. Cet appareil doit accepter toute interférence reçue, y compris des interférences pouvant provoquer un fonctionnement non désiré.



### Avertissement de la FCC

Les modifications apportées à l'appareil qui ne sont pas expressément approuvées par le fabricant peuvent révoquer votre droit d'utiliser l'appareil en vertu des règles de la FCC.

### Conformité aux normes de sécurité

Cet appareil est conforme aux normes de sécurité suivantes :

- CEI 60601-1 : Appareils électromédicaux - Exigences générales de sécurité
- CEI 60601-1-6 : Appareils électromédicaux – Section 1-6 : Exigences générales de sécurité - Norme collatérale : Aptitude à l'utilisation
- CEI 80601-2-60 : Appareils électromédicaux - Section 2-60 : Exigences particulières pour la sécurité de base et les performances essentielles des équipements dentaires
- CEI 60825-1 : Sécurité des produits laser – Section 1 : Classification des équipements, exigences et guide de l'utilisateur
- CEI 62471 : Sécurité photobiologique des lampes et des systèmes de lampes

### Conformité CSA

Cet appareil est conforme aux normes CSA.

Ce marquage signifie que le produit est certifié pour les marchés américain et canadien, selon les normes américaines et canadiennes applicables.



### Conformité CE





Cet appareil est conforme aux règlements du Conseil (UE) 2017/745 pour les dispositifs médicaux.



## Nature du rayonnement émis par le scanner – French





- **Rayonnement électromagnétique** - Lorsqu'il est utilisé comme indiqué, le niveau de rayonnement électromagnétique du scanner iTero est similaire à celui d'un ordinateur personnel.
- **Laser et rayonnement LED** - Le scanner iTero est classé comme un produit laser de classe 1 et comme Groupe 1 pour le rayonnement LED.





## Symboles – French







Les symboles suivants peuvent apparaître sur iTero Lumina les composants matériels et peuvent apparaître dans ce document et dans d'autres iTero Lumina documents.







Symbole	Nom du symbole	Description du symbole	Numéro et nom standard	Numéro de référence du symbole
	Consulter le manuel/la brochure d'utilisation	Pour signifier que le manuel d'instructions/livret doit être lu avant d'utiliser cet appareil.	ISO 7010  Symboles graphiques - Couleurs de sécurité et signaux de sécurité - Signaux de sécurité enregistrés.	M002
	Pièce appliquée de type B	Pour identifier une pièce appliquée de type B conforme à la CEI 60601-1.	CEI 60417  Symboles graphiques à utiliser sur l'équipement.	5840
	Ne pas réutiliser	Indique un dispositif médical destiné à un usage unique.	EN/ISO 15223-1*	5.4.2
	Code du lot	Indique le code du lot du fabricant, afin que le lot ou l'expédition de produits puisse être identifié.	EN/ISO 15223-1*	5.1.5



Symbole	Nom du symbole	Description du symbole	Numéro et nom standard	Numéro de référence du symbole
	Déchets d'équipements électriques et électroniques (DEEE)	<p>Une collecte séparée des déchets électriques et des équipements électroniques est requise. Conformément à la directive européenne sur les déchets d'équipements électriques et électroniques (DEEE), ne jetez pas ce produit avec les déchets ménagers ou urbains. Cet appareil contient des matériaux DEEE.</p> <p>Veillez contacter votre service client local pour organiser la collecte du scanner.</p>	EN 50419  Marquage des équipements électriques et électroniques (EEE) en ce qui concerne la collecte séparée des déchets d'EEE (DEEE).	N/A
	Attention	Indique qu'il faut être prudent lors de l'utilisation de l'appareil ou de la commande à proximité de l'endroit où le symbole est placé, ou que la situation actuelle nécessite une sensibilisation de l'opérateur ou une action de l'opérateur afin d'éviter des conséquences indésirables.	EN/ISO 15223-1*	5.4.4

Symbole	Nom du symbole	Description du symbole	Numéro et nom standard	Numéro de référence du symbole
	Limitation de pression atmosphérique	Indique la plage de pression atmosphérique à laquelle le dispositif médical peut être exposé en toute sécurité.	EN/ISO 15223-1*	5.3.9
	Limitation d'humidité	Indique la plage d'humidité à laquelle le dispositif médical peut être exposé en toute sécurité.	EN/ISO 15223-1*	5.3.8
	Fragile, à manipuler avec précaution	Indique un dispositif médical qui peut être cassé ou endommagé s'il n'est pas manipulé avec précaution.	EN/ISO 15223-1*	5.3.1
	Vers le haut	Pour indiquer la position verticale correcte de l'emballage de transport.	ISO 7000 Symboles graphiques à utiliser sur l'équipement Symboles enregistrés	0623
	Courant continu	Pour indiquer sur la plaque signalétique que l'équipement est adapté au courant continu (CC) uniquement.	CEI 60417 Symboles graphiques à utiliser sur l'équipement.	5031

Symbole	Nom du symbole	Description du symbole	Numéro et nom standard	Numéro de référence du symbole
	Tige	Unité de scan	N/A	N/A
	Identifiant unique de l'appareil	Indique un opérateur qui contient l'information de l'identifiant d'appareil unique.	EN/ISO 15223-1*	5.7.10
	Pays de fabrication (y compris la date de fabrication).	Identifier le pays de fabrication des produits.  La date de fabrication est située à côté du symbole.	EN/ISO 15223-1*	5.1.11
	Ne pas exposer directement aux rayons du soleil	Indique un dispositif médical qui doit être protégé des sources de lumière.	EN/ISO 15223-1*	5.3.2
	Dispositif sur ordonnance	<b>ATTENTION</b> : Sur ordonnance uniquement. La loi fédérale américaine limite la vente de cet appareil par ou pour le compte d'un dentiste, d'un orthodontiste ou d'un professionnel dentaire agréé. Le système constitue un dispositif médical sur ordonnance et ne doit être manipulé que par des professionnels de santé dentaire qualifiés.	21 CFR 801.15(c) (1)(i)F	Étiquetage - Dispositifs médicaux ; importance des mentions d'étiquetage requises ; utilisation de symboles dans l'étiquetage.

Symbole	Nom du symbole	Description du symbole	Numéro et nom standard	Numéro de référence du symbole
	Fabricant	Indique le fabricant du dispositif médical.	EN/ISO 15223-1*	5.1.1
	Numéro de catalogue	Indique le numéro de catalogue du fabricant, afin que le dispositif médical puisse être identifié.	EN/ISO 15223-1*	5.1.6
	Numéro de série	Indique le numéro de série fourni par le fabricant permettant l'identification de chaque dispositif médical spécifique.	EN/ISO 15223-1*	5.1.7
	Courant alternatif.	Pour indiquer sur la plaque signalétique que l'équipement est adapté au courant alternatif (CA) uniquement.	CEI 60417  Symboles graphiques à utiliser sur l'équipement.	5032
	Garder au sec	Indique un dispositif médical qui doit être protégé de l'humidité.	EN/ISO 15223-1*	5.3.4
	Limite de température	Indique les limites de température auxquelles le dispositif médical peut être exposé en toute sécurité.	EN/ISO 15223-1*	5.3.7
	Dispositif médical	Indique que l'article est un appareil médical.	EN/ISO 15223-1*	5.7.7

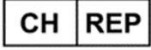
Symbole	Nom du symbole	Description du symbole	Numéro et nom standard	Numéro de référence du symbole
	Consulter les instructions d'utilisation ou consulter les instructions électroniques d'utilisation.	Indique la nécessité pour l'utilisateur de consulter les instructions d'utilisation.	EN/ISO 15223-1*	5.4.3
	Bus série universel (USB), port/prise	Pour identifier un port USB.	ISO 7000  Symboles graphiques à utiliser sur l'équipement - Symboles enregistrés	3650
	Batterie	Identifier l'emplacement de la batterie du panneau PC.	N/A	N/A
	Veille	Identifier le bouton-poussoir de mise sous tension/veille.	CEI 60417  Symboles graphiques à utiliser sur l'équipement.	5009
	Utiliser avant le	Indique la date après laquelle l'appareil médical ne doit plus être utilisé.	EN/ISO 15223-1*	5.1.4
	Avertissement ; Faisceau laser	Pour avertir d'un faisceau laser.  Produit laser de classe 1.	EN/ISO 7010  Symboles graphiques - Couleurs de sécurité et signaux de sécurité - Signaux de sécurité enregistrés.	W004

Symbole	Nom du symbole	Description du symbole	Numéro et nom standard	Numéro de référence du symbole
	État importateur	Indique l'entité qui importe le dispositif médical dans les paramètres régionaux.	EN/ISO 15223-1*	5.1.8
	Représentant agréé suisse	Indique le représentant autorisé en Suisse.	MU600_00_016 version 5.0 Obligations Opérateurs économiques CH.	N/A
	Conforme RoHS pour la Chine.	Indique que le produit électrique contient certaines substances dangereuses et peut être utilisé en toute sécurité pendant la période d'utilisation de protection de l'environnement de 10 ans et doit être recyclé après la fin de sa période d'utilisation de protection de l'environnement.	SJ/T 11364  Marquage pour la limitation de l'utilisation de substances dangereuses dans les produits électriques et électroniques.	N/A
	Marquage CE/marquage CE de conformité	Indique qu'un dispositif est conforme aux exigences applicables énoncées dans le règlement UE MDR 2017/745 et toute autre législation d'harmonisation de l'Union applicable prévoyant son apposition.	RÈGLEMENT (UE) 2017/745 DU PARLEMENT EUROPÉEN ET DU CONSEIL du 5 avril 2017 relatif aux dispositifs médicaux	Annexe V du RDM UE 2017/745

Symbole	Nom du symbole	Description du symbole	Numéro et nom standard	Numéro de référence du symbole
	Représentant autorisé dans la Communauté européenne/Union européenne	Représentant autorisé dans la Communauté européenne/Union européenne.	EN/ISO 15223-1*	5.1.2

\***Références du glossaire** : EN/ISO 15223-1 Dispositifs médicaux -Symboles à utiliser avec les étiquettes de dispositifs médicaux , l'étiquetage et les informations à fournir - Partie 1 : Exigences générales



## Consignes de sécurité – French

Avant d'utiliser le système, tous les utilisateurs sont tenus de lire et de comprendre ces consignes de sécurité.

### Sécurité Laser et LED

- La iTero Lumina tige est classée en tant que produit laser de classe 1 selon la norme CEI 60825-1, Sécurité des produits laser, et groupe 1 selon la norme CEI 62471, Sécurité photobiologique des lampes et des systèmes de lampes (LED).
- **Avertissement** : Évitez tout contact visuel avec le faisceau laser ou l'émission de LED blanche scintillante. Le contact avec les yeux peut les endommager.
- **Avertissement** : Évitez d'activer la tige lorsque la pointe de celle-ci se trouve en dehors de la bouche du patient, afin d'éviter des lésions oculaires.
- **Avertissement** : Afin d'éviter tout contact visuel:
  - Évitez de diriger la lumière de la tige directement dans les yeux de quelqu'un.
  - Évitez d'activer la tige lorsque son extrémité se trouve à l'extérieur de la bouche du patient.
  - Évitez de placer la tige dans le socle tant que l'opération de scan est toujours active.
  - Placez la tige dans le socle avec la fenêtre optique tournée vers le socle.
- Pour une protection supplémentaire, il est recommandé que les enfants portent des lunettes de protection pendant les procédures de scan.
- La tige émet une lumière laser bleue (450 nm de classe 1), une lumière laser verte (520 nm de classe 1), ainsi que des émissions de LED blanches. Évitez de diriger la lumière de la tige directement dans les yeux de quelqu'un.

### Alimentation électrique

Le système est alimenté via une batterie interne de qualité médicale. Dans les iTero Lumina scanners en configuration chariot, l'alimentation électrique est placée dans la base du support de roue. Dans les iTero Lumina scanners en configuration mobile, l'alimentation électrique est externe.

### Puissance de la batterie

- Charge - la batterie du scanner sera complètement chargée après avoir été branchée à une source d'alimentation pendant 2h30.
  - Une batterie entièrement chargée permet 30 minutes de scan à l'aide du scanner en configuration chariot ou 10 minutes à l'aide du scanner en configuration mobile.  
Les scanners en configuration chariot sont fournis avec deux batteries rechargeables Li-ion.  
Les scanners en configuration mobile sont fournis avec une batterie. Les batteries sont placées dans la partie inférieure à l'arrière de l'unité informatique.
- ATTENTION** : Il existe un risque de brûlure et/ou d'explosion de la batterie si l'écran est endommagé et/ou si la batterie n'est pas remplacée conformément aux instructions d'Align. N'utilisez pas le scanner en cas de chute ou si des dommages sont constatés. Contactez le service client.
- Utilisez uniquement l'adaptateur CA/CC d'origine connecté au système pour charger les batteries.

- **ATTENTION** : Une batterie Li-ion défaillante commence à siffler, à gonfler et à laisser fuir des électrolytes. Les électrolytes sont constitués de sel de lithium dans un solvant organique (hexafluorophosphate de lithium), qui est très inflammable. La combustion d'électrolytes peut enflammer des matériaux combustibles à proximité immédiate.  
Veuillez noter qu'il existe un risque de brûlure associé à cette situation.
  - L'écran doit être stocké et utilisé conformément aux conditions environnementales indiquées dans ce manuel. N'exposez pas le scanner à des sources de chaleur extrêmes, telles que des radiateurs et des cheminées.
  - N'utilisez jamais l'appareil sans batterie ! N'utilisez pas les batteries à des fins autres que l'usage prévu du produit. Jetez les batteries usagées conformément aux instructions du fabricant et aux exigences locales.
  - Remplacez les batteries uniquement par des batteries fournies par Align pour la configuration spécifique de votre appareil.
- Avertissements électriques**
- **Avertissement** : Ne retirez pas les panneaux ni les capots externes afin d'éviter les chocs électriques. L'appareil ne contient aucune pièce remplaçable par l'utilisateur. Sur iTerro Lumina les scanners, vous pouvez ouvrir le capot du panneau de diagnostic en cas de défaillance du système uniquement quand le service clients vous le demande.
  - **Avertissement** : Ne connectez aucun périphérique externe non approuvé tel que des webcams, des périphériques USB, un réseau local ou tout autre équipement alimenté par le secteur, afin d'éviter tout choc électrique.
  - **Avertissement** : Ne retirez pas et ne remplacez pas les batteries sans avoir d'abord débranché le câble d'alimentation du secteur puis débranché le câble d'alimentation de l'écran.
  - **Avertissement** : Ne connectez pas le scanner à une alimentation principale sans prise terre, afin d'éviter tout choc électrique.
  - **Avertissement** : Utilisez uniquement le câble d'alimentation fourni, qui a un fil terre de protection. Ne connectez pas un câble d'alimentation qui n'est pas fourni par la Align Technology et/ou n'utilisez pas de câble électrique ou de rallonge pour vous connecter au système afin d'éviter les chocs électriques.
- Réseau local sans fil**
- Le système est équipé d'une unité de réseau local sans fil.
  - **Avertissement** : Ne connectez jamais le câble LAN au scanner, afin d'éviter tout choc électrique.
  - Lors de l'utilisation du produit, maintenez une distance d'au moins 20 cm entre l'unité informatique et toute personne pour garantir la conformité aux exigences d'exposition aux RF.
- Classifications de sécurité**
- Type de protection contre les chocs électriques : Classe 1.
  - Type de pièce appliquée : Type B.
  - Degré de protection contre les infiltrations d'eau dangereuses : Ordinaire.
  - L'équipement ne convient pas à une utilisation en présence de mélanges anesthésiques inflammables.
  - Mode de fonctionnement : En continu.

**Dispositif médical sur ordonnance**

Le système constitue un dispositif médical sur ordonnance et ne doit être manipulé que par des professionnels de santé dentaire qualifiés.

**Avertissements relatifs au scanner**

- **Avertissement** : Lorsque le système n'est pas utilisé, la tige doit être placée dans le socle, la fenêtre optique faisant face au socle.
- **Avertissement** : Évitez d'utiliser la tige sans manchon jetable afin de réduire le risque de contamination croisée, d'inconfort et même de brûlures.
- **ATTENTION** : Évitez de tordre, de nouer, de tirer ou de marcher sur le câble de la tige et le câble d'alimentation.
- **Avertissement** : N'utilisez pas l'équipement en cas de dysfonctionnement du scanner ou si des dommages physiques sont constatés, afin d'éviter tout choc électrique ou blessure physique. Dès que des dommages sont observés, arrêtez immédiatement le scan, débranchez le système de l'alimentation et appelez le service client.
- **Avertissement** : Ne nettoyez pas, ne désinfectez pas et n'utilisez pas la tige en cas de dommage. Veuillez contacter le service client iTero pour plus d'instructions.
- **Avertissement** : N'utilisez pas la tige si vous constatez des dommages sur la surface optique. Veuillez contacter le service client iTero pour plus d'instructions.
- **Avertissement** : N'utilisez pas la tige si des dommages sont détectés. Veuillez contacter le service clients iTero pour plus d'instructions.
- **ATTENTION** : N'utilisez pas le socle si des dommages sont détectés. Veuillez contacter le service client iTero pour plus d'instructions.
- **ATTENTION** : Ne nettoyez pas, ne désinfectez pas et n'utilisez pas le socle en cas de dommage. Veuillez contacter le service client iTero pour plus d'instructions.
- **ATTENTION** : N'utilisez pas l'écran du scanner si vous constatez des dommages. Veuillez contacter le service client iTero pour plus d'instructions.

**Nettoyage & désinfection**

Afin de réduire le risque de contamination croisée, il est obligatoire de respecter les éléments suivants :

- Nettoyez et désinfectez soigneusement la tige, le socle et les autres composants du système conformément aux instructions fournies dans [Care and maintenance](#), avant la première utilisation et immédiatement après chaque utilisation. Appliquez un nouveau manchon avant chaque patient, comme décrit dans [Applying a sleeve](#).
- **Avertissement** : Lors de la désinfection de la tige, du socle et d'autres composants du système, utilisez plusieurs lingettes fraîches, si nécessaire, pour garder les surfaces des composants du système humides pendant toute la durée du contact, comme recommandé par le fabricant de lingettes de désinfection concerné.
- **Avertissement** : Évitez de modifier le processus de nettoyage et de désinfection recommandé et de modifier ou remplacer les matériaux recommandés afin d'éviter les risques biologiques.
- Désinfectez l'écran tactile immédiatement après chaque patient.
- **Avertissement** : Enlevez et remplacez les gants après chaque patient. Jetez les gants déchirés, contaminés ou déjà enlevés.

- **Avertissement** : Remplacez le Manchon iTero Lumina entre chaque patient. Ne pas changer la manchon entre les patients peut entraîner le transfert de micro-organismes et d'autres contaminants d'un patient à un autre par inadvertance.
  - Un nouveau Manchon iTero Lumina ou le manchon de protection peut être appliqué sur la tige après le nettoyage et la désinfection.
- Déballage & installation**
- Le système doit être déballé et installé conformément aux instructions fournies par Align Technology, décrites dans [Assembly instructions](#).
- ATTENTION:** Contactez le service client si la boîte du scanner est endommagée ou si l'indicateur ShockDot sur la boîte a été activé. Ne déballiez pas le scanner.
- Remarques :**
- Seule une webcam fournie par Align doit être connectée au port USB à des fins de formation.
  - La webcam doit être déconnectée après chaque session de formation.
  - L'objectif de la webcam doit être recouvert lorsque la webcam n'est pas activement utilisée.
- Environnement de travail**
- **Avertissement** : Le système doit être déplacé d'une pièce à une autre avec le plus grand soin pour éviter de l'endommager.
  - **Attention** : Ne couvrez pas/ne bloquez pas les bouches d'aération sur la tige et l'unité informatique.
  - Le système est conçu pour une utilisation en intérieur uniquement. Il ne doit pas être exposé directement à la lumière du soleil, à une chaleur excessive ou à l'humidité.
  - Si le système vient juste d'être déplacé dans un endroit en provenance d'un environnement chaud, froid ou humide, laissez le matériel s'adapter à la température ambiante pour éviter la condensation interne.
- Précaution contre les interférences électromagnétiques**
- L'appareil et son scanner manchon ont été testés et jugés conformes aux exigences relatives aux dispositifs médicaux selon la norme IEC60601-1-2. Cette norme vise à fournir une protection raisonnable contre les interférences électromagnétiques nocives et l'immunité dans une configuration électromagnétique clinique conventionnelle. Ne connectez pas l'appareil à des appareils ou accessoires externes, y compris la webcam, pendant une utilisation clinique.
- Évitez de placer cet appareil à proximité d'équipements de transmission de fréquence, y compris des produits sans fil ou d'autres sources d'interférences électriques et électromagnétiques (par exemple, téléphones portables/5G, radios mobiles bidirectionnelles, appareils électriques, RFID, IRM, diathermie, électrocautérisation, transfert d'énergie sans fil (WPT)). Des niveaux élevés de telles interférences, en raison de la proximité ou de la force de la source, peuvent entraîner une perturbation des performances de cet appareil. Dans ce cas, l'appareil peut être remis en mode de fonctionnement après une intervention de l'utilisateur ou par une récupération automatique.

Maintenez une distance de séparation minimale conformément aux distances de séparation recommandées entre l'équipement de communication RF portable et mobile et le iTero Lumina système d'imagerie dentaire du et suivez le tableau de séparation décrit en [Recommended Separation Distances Between Portable and Mobile RF Communications Equipment and the iTero Lumina Intraoral scanner that is not Life-Supporting](#).

**Avertissement:** Gardez le socle de la tige à 15 cm des dispositifs médicaux sensibles au magnétisme tels que les implants cochléaires, les neurostimulateurs, les stents et les shunts.

### Informations générales

#### Remarques :

- N'apportez aucune modification à cet équipement.
- À utiliser uniquement sur les patients en mesure de se conformer aux instructions.
- Configuration chariot uniquement : Ne retirez pas l'unité informatique du support après l'assemblage.
- Suivez les instructions pour stocker la pointe de la tige (sonde) dans des conditions appropriées, comme décrit dans [Storage and maintenance](#)
- Suivez les instructions pour nettoyer et désinfecter correctement l'appareil, comme décrit dans [Care and maintenance](#)
- Suivez les instructions pour entretenir et manipuler correctement l'instrument, comme décrit dans [Care and maintenance](#)
- Ne connectez aucun périphérique externe non approuvé par Align, tel que des webcams, des périphériques USB, des réseaux locaux ou d'autres équipements fonctionnant sur secteur.

### Notification d'incident

Tout incident grave lié à l'appareil iTero doit être signalé à Align Technology Ltd. et à l'autorité compétente du pays dans lequel l'utilisateur et le patient sont établis.

### Manchons iTero Lumina

- **Avertissement :** Les Manchons iTero Lumina sont destinés à un usage unique. Ne les réutilisez pas.
- **Avertissement :** Les Manchons iTero Lumina sont destinés à un usage unique et doivent être jetés et remplacés après chaque patient afin d'éviter toute contamination croisée.
- **Avertissement :** Pour réduire le risque de contamination croisée, il est essentiel que le iTero Lumina scanner soit entièrement nettoyé et désinfecté immédiatement après chaque patient, et que le Manchon iTero Lumina soit remplacé entre les patients, comme décrit [Applying a sleeve](#).
- **ATTENTION :** N'utilisez pas les Manchons iTero Lumina après la date de péremption.
- **Avertissement :** Si vous remarquez des dommages, n'utilisez pas les manchons Manchons iTero Lumina et contactez le support client.
- Les Manchons iTero Lumina sont fournis non stériles et **ne doivent pas** être stérilisés avant utilisation.
- Les Manchons iTero Lumina sont conformes aux sections applicables de la norme internationale de biocompatibilité ISO 10993.

- **ATTENTION:** Jetez les Manchons iTero Lumina usagés conformément aux procédures d'utilisation standard ou aux réglementations locales relatives à l'élimination des déchets médicaux contaminés.



## Table of contents

<b>1</b>	<b>Introduction to iTero Lumina™ intraoral scanners</b>	<b>1</b>
1.1	Intended purpose/Intended use	2
1.2	Indications for use	2
1.3	Contraindications	2
1.4	Intended patient population	2
1.5	Intended users	2
1.6	Use environment	2
1.7	Clinical benefits	2
1.8	iTero Lumina hardware	3
1.8.1	iTero Lumina cart configuration	3
1.8.2	iTero Lumina mobile configuration	4
1.8.3	iTero Lumina wand	5
1.9	About this manual	7
<b>2</b>	<b>Assembly instructions</b>	<b>8</b>
2.1	Assembling the iTero Lumina scanner – cart configuration	8
2.2	Assembling the iTero Lumina scanner – mobile configuration	13
2.2.1	Initial assembly	14
2.2.2	Moving the scanner within the clinic	16
2.2.3	Using the trolley for transportation	16
2.2.4	Optional protective trolley cover	19
2.2.5	VESA mounting	19
<b>3</b>	<b>Getting started</b>	<b>22</b>
3.1	Logging in to the scanner for the first time	22
3.2	Registering the scanner – Make It Mine process	22
3.3	Working in Demo Mode	28
3.3.1	Align Oral Health Suite	32
3.3.2	Exiting Demo Mode	33
<b>4</b>	<b>Working with the scanner</b>	<b>34</b>
4.1	Logging in to the scanner	34
4.1.1	Resetting your password	38
4.1.2	Updating the scanner software	40
4.2	Logging out of the scanner	45

4.3	Shutting down the scanner	46
4.4	Moving the scanner	46
4.4.1	Moving the iTero Lumina cart-configuration scanner	46
4.4.2	Carrying the iTero Lumina mobile-configuration scanner within the clinic	47
4.4.3	Transporting the iTero Lumina mobile-configuration scanner between clinics	48
4.5	User interface	49
4.5.1	Scanner toolbar	52
4.5.2	Touch-screen gestures	55
4.6	Defining the scanner settings	55
4.6.1	Defining the Device settings	57
4.6.2	Defining the User settings	61
4.6.3	Defining the System settings	68
<b>5</b>	<b>Starting a new scan</b>	<b>72</b>
5.1	Applying a sleeve	72
5.2	Starting the scanning process	73
5.3	Filling in the Rx	75
5.3.1	Filling in the Rx for Study Model/iRecord procedures	78
5.3.2	Filling in the Rx for Invisalign   Vivera procedures	79
5.3.3	Filling in the Rx for Fixed Restorative procedures	81
5.3.4	Filling in the Rx for Implant Planning procedures	95
5.3.5	Filling in the Rx for Denture/Removable procedures	98
5.3.6	Filling in the Rx for Appliance procedures	103
5.3.7	Saving list items as favorites	103
5.3.8	Confirming a new sleeve between patients	105
5.4	Patient management	106
5.4.1	Adding new patients	107
5.4.2	Searching for existing patients	108
5.4.3	Editing the patient details	110
5.4.4	Clearing the patient details from the New Scan window	112
5.5	Scanning the patient	113
5.5.1	Scanning guidance	114
5.5.2	Scanning best practices	116
5.5.3	Scan options	116
5.5.4	Editing a scan	121
5.6	Viewing the scan	121

5.6.1	Missing scan segment notifications .....	122
5.6.2	Using the scan timer .....	124
5.7	Sending the scan .....	124
5.8	Working with the Viewer .....	128
5.9	Removing the sleeve .....	131
<b>6</b>	<b>Working with patients .....</b>	<b>133</b>
6.1	Searching for patients .....	133
6.2	Viewing the patient details .....	135
6.3	Creating a new scan for a specific patient .....	136
6.4	Viewing the Rx .....	138
6.5	Viewing previous scans in the Viewer .....	139
<b>7</b>	<b>Working with orders .....</b>	<b>141</b>
7.1	Working with returned orders .....	144
<b>8</b>	<b>Viewing messages .....</b>	<b>145</b>
<b>9</b>	<b>Working with MyiTero .....</b>	<b>146</b>
<b>10</b>	<b>iTero scanner features and tools .....</b>	<b>147</b>
10.1	Comparing previous scans using iTero TimeLapse technology .....	147
10.2	Invisalign Outcome Simulator Pro .....	151
10.3	Invisalign Outcome Simulator .....	151
10.4	Invisalign Progress Assessment .....	151
10.5	Invisalign Go system .....	152
10.6	Editing tools .....	153
10.6.1	Deleting a segment .....	153
10.6.2	Working with the Trim tool .....	155
10.6.3	Working with the Eraser tool .....	158
10.6.4	Disabling auto-cleanup .....	161
10.6.5	Enabling saliva detection .....	163
10.7	Working with the Occlusal Clearance tool .....	163
10.8	Working with the Die Separation tool .....	166
10.9	Working with the Margin Line tool .....	169
10.9.1	Automatically defining the margin line .....	169
10.9.2	Manually defining the margin line .....	171
10.10	Working with the Review tool .....	172
10.10.1	Zooming in to and out of the images in the image pane .....	174
10.10.2	Adjusting the brightness and contrast of images in the image pane .....	175

10.10.3	Capturing the Review tool images .....	177
10.11	Working with the Snapshot tool .....	177
<b>11</b>	<b>Care and maintenance .....</b>	<b>183</b>
11.1	Handling the wand and cable .....	183
11.2	Cleaning and disinfecting the wand .....	184
11.2.1	Preparation before cleaning and disinfection .....	184
11.2.2	Wand cleaning and disinfection .....	185
11.2.3	Drying – wand body .....	187
11.2.4	Storage and maintenance .....	187
11.3	Cleaning and disinfecting the cradle .....	187
11.3.1	Preparation before cleaning and disinfection .....	188
11.3.2	Cradle cleaning and disinfection .....	188
11.3.3	Drying – cradle .....	189
11.3.4	Storage and maintenance .....	189
11.4	Cleaning and disinfecting the scanner touch screen and the main handle .....	190
11.5	General cleaning and disinfection comments .....	190
11.6	Approved cleaning and disinfecting materials .....	191
11.6.1	Approved cleaning and disinfection materials (not relevant for Australia) .....	191
11.6.2	Approved cleaning and disinfection materials (Australia only) .....	191
11.7	Disposal instructions .....	192
<b>Appendix A:</b>	<b>Clinic LAN network guidelines .....</b>	<b>193</b>
A.1	Introduction .....	193
A.2	Preparations .....	193
A.3	Router guidelines .....	193
A.4	Internet connection guidelines .....	194
A.5	Firewall .....	194
A.6	Wi-Fi tips .....	194
A.7	Align hostname recommendations .....	195
<b>Appendix B:</b>	<b>EMC declaration .....</b>	<b>197</b>
B.1	EMC declaration – iTero Lumina .....	197
B.2	Guidance and Align Technology’s Declaration – Electromagnetic Immunity – for iTero Lumina that is not Life-Supporting .....	201
B.3	Recommended Separation Distances Between Portable and Mobile RF Communications Equipment and the iTero Lumina Intraoral scanner that is not Life-Supporting .....	202
<b>Appendix C:</b>	<b>FCC compliance information statement (SDoC) .....</b>	<b>203</b>

<b>Appendix D: iTero Lumina Family product security whitepaper .....</b>	<b>205</b>
<b>Appendix E: System specifications .....</b>	<b>207</b>

## Table of figures

Figure 1: Front view of the iTero Lumina cart-configuration intraoral scanner .....	3
Figure 2: Rear view of the iTero Lumina cart-configuration intraoral scanner .....	4
Figure 3: Front view of the iTero Lumina mobile-configuration intraoral scanner .....	4
Figure 4: Rear view of the iTero Lumina mobile-configuration intraoral scanner .....	5
Figure 5: iTero Lumina wand .....	5
Figure 6: Protective sleeve .....	6
Figure 7: Disposable sleeve .....	6
Figure 8: Removing the wand from the cradle .....	12
Figure 9: Moving the scanner .....	12
Figure 10: Do not lift the scanner using the main handle .....	12
Figure 11: Do not allow the power pack to dangle in the air .....	21
Figure 12: Never tilt the screen more than 45 degrees .....	21
Figure 13: Welcome screen .....	22
Figure 14: Connect page listing the available networks .....	23
Figure 15: Entering the security key .....	24
Figure 16: Scanner is connected to the Internet and online .....	24
Figure 17: Verifying the communication with Align .....	25
Figure 18: Selecting the time zone .....	25
Figure 19: Registering the system to customize the setup .....	26
Figure 20: Example of an iTero subscription package .....	26
Figure 21: License agreement .....	27
Figure 22: Checking for updates .....	27
Figure 23: System is registered and ready .....	28
Figure 24: iTero Lumina logo .....	29
Figure 25: Demo Mode option .....	29
Figure 26: Login window with a list of demo users .....	30
Figure 27: Demo Login button .....	30
Figure 28: Demo Mode home screen .....	31
Figure 29: Past Orders pane – options .....	31
Figure 30: Align Oral Health Suite home screen .....	32
Figure 31: iTero Lumina logo .....	33
Figure 32: Exiting Demo mode .....	33

Figure 33: Login window .....	34
Figure 34: Unexpected shutdown notification .....	35
Figure 35: Password is masked .....	36
Figure 36: iTero home screen .....	37
Figure 37: Forgot Password button .....	38
Figure 38: Email field for forgotten password .....	38
Figure 39: Security answer field .....	39
Figure 40: Software Updates/Security Updates window – scheduling options .....	40
Figure 41: Connect the scanner to the AC power .....	41
Figure 42: Installation in progress .....	41
Figure 43: Installation completed successfully .....	42
Figure 44: Software updates – number of days until the updates must be installed .....	42
Figure 45: Software updates – last day .....	43
Figure 46: Software updates notification – Login window .....	44
Figure 47: Software updates notification – home screen .....	45
Figure 48: Moving the scanner .....	47
Figure 49: Carrying the scanner between rooms within the clinic .....	48
Figure 50: Transporting the scanner between clinics .....	48
Figure 51: iTero home screen .....	49
Figure 52: Percentage of remaining battery charge .....	50
Figure 53: Help overlay including the e-manual and Customer Support buttons .....	51
Figure 54: Scanner toolbar .....	52
Figure 55: Percentage of remaining battery charge .....	53
Figure 56: Help overlay including e-manual and Customer Support buttons .....	54
Figure 57: Settings window .....	56
Figure 58: Brightness settings .....	57
Figure 59: Volume settings .....	57
Figure 60: List of nearby Wi-Fi networks .....	58
Figure 61: Connecting to the clinic Wi-Fi network .....	59
Figure 62: Forgetting or Disconnecting from the network .....	59
Figure 63: Time zone settings .....	60
Figure 64: Scan Settings window .....	61
Figure 65: Only the scanning range is highlighted .....	63
Figure 66: Rx Settings window .....	64
Figure 67: Signature Settings window .....	66

Figure 68: Localization window .....	67
Figure 69: Login Settings window .....	68
Figure 70: Diagnostics window .....	69
Figure 71: Licensing Information window .....	70
Figure 72: System Information window – iTero Lumina mobile configuration .....	71
Figure 73: Remove the protective sleeve .....	72
Figure 74: Gently slide the new sleeve into place .....	73
Figure 75: Do not touch the sleeve window .....	73
Figure 76: New Scan window showing an empty Rx form and progress toolbar .....	74
Figure 77: New Scan window .....	76
Figure 78: Selecting the required procedure .....	77
Figure 79: Order and Attachment areas – Study Model/iRecord procedure .....	79
Figure 80: Order area – Invisalign   Viverra procedure .....	80
Figure 81: Tooth Diagram, and Attachments areas – Fixed Restorative procedure .....	82
Figure 82: Multi-Bite options .....	83
Figure 83: List of fixed restorative treatment options .....	83
Figure 84: Treatment settings window – Onlay restoration .....	84
Figure 85: Selected tooth and Treatment Information area – Onlay restoration .....	85
Figure 86: Treatment settings window – Crown restoration .....	86
Figure 87: Additional information area – Crown restoration .....	87
Figure 88: Selected tooth and Treatment Information area – Crown restoration .....	88
Figure 89: Copy restoration settings from a tooth requiring the same treatment type .....	88
Figure 90: Treatment settings window – Implant Based restoration .....	89
Figure 91: Expanded Restoration Type area .....	90
Figure 92: Expanded Crown area .....	90
Figure 93: Treatment settings window – Bridge restoration .....	91
Figure 94: Bridge range and teeth to be included .....	91
Figure 95: List of in-bridge treatment options .....	92
Figure 96: Bridge restoration – Pontic settings .....	92
Figure 97: Additional information area – Bridge restoration .....	93
Figure 98: Bridge treatment options – Implant Based .....	94
Figure 99: Expanded Restoration Type area .....	94
Figure 100: Expanded Crown area .....	95
Figure 101: Implant Planning procedure types .....	95

Figure 102: Implant Planning procedure – Tooth Diagram and Attachment areas for Surgical Guide Tooth Supported .....	96
Figure 103: Defining the teeth that need to be implanted .....	97
Figure 104: Implant Position window .....	97
Figure 105: Supporting teeth and teeth to be implanted displayed in the Tooth Diagram and Treatment Information areas .....	98
Figure 106: Denture/Removable procedure – Tooth Diagram and Attachment areas .....	99
Figure 107: Denture/Removable procedure types .....	100
Figure 108: Scanning option for scanning both the existing dentures and the patient .....	101
Figure 109: Defining the teeth to be included in the denture – Full Denture Implant Based procedure type .....	101
Figure 110: Implant Based settings window .....	102
Figure 111: Appliance procedure types .....	103
Figure 112: Adding a favorite material .....	104
Figure 113: Favorite materials pinned to the top of the Material list .....	104
Figure 114: Confirming that a new sleeve is attached .....	105
Figure 115: Popup confirmation message before scanning .....	106
Figure 116: Adding a new patient .....	107
Figure 117: Message notifying that a patient with the same details exists .....	108
Figure 118: Patient area of the New Scan window – searching for an existing patient .....	108
Figure 119: Search Patient window with a search field .....	109
Figure 120: Search criteria in the search field and list of matching patients .....	109
Figure 121: Selecting the required patient .....	110
Figure 122: Selected patient displayed in the Patient area of the New Scan window .....	110
Figure 123: Patient area of New Scan window – editing a patient .....	111
Figure 124: Edit Patient window and Update button .....	111
Figure 125: Message that a patient with the same details already exists .....	112
Figure 126: Clear patient details button .....	112
Figure 127: Clear confirmation message .....	113
Figure 128: Wand initialization icon and progress bar .....	113
Figure 129: Recommended scanning sequence – lower jaw .....	114
Figure 130: Saliva detection – area with saliva bubbles is shown as a hole and a drop icon is displayed .....	115
Figure 131: Saliva detection – area with saliva bubbles is displayed in light blue when scanning is paused .....	115
Figure 132: Areas with missing anatomy shown with and without additional scan feedback – monochrome .....	117
Figure 133: Areas with missing anatomy shown with and without additional scan feedback – color mode .....	117
Figure 134: Model displayed in color and monochrome mode .....	118

Figure 135: Tap the opposite arch or tap the arrows to select it .....	119
Figure 136: Unstitched scanned segments displayed on the right of the Scan window. ....	120
Figure 137: Switching to the main segment .....	120
Figure 138: Deleting an unstitched segment .....	120
Figure 139: Editing tools .....	121
Figure 140: Missing scan message and missing segments highlighted in red .....	123
Figure 141: Scan timer button on the toolbar and scan time .....	124
Figure 142: Notification about missing treatment information .....	125
Figure 143: Missing fields highlighted in red in the Treatment Information area .....	125
Figure 144: Complete Scan window with yellow banner for orders on hold .....	126
Figure 145: Invisalign Outcome Simulator Pro progress shown in the Viewer .....	127
Figure 146: Invisalign Outcome Simulator Pro progress shown in the patient's profile page .....	127
Figure 147: Viewer option in the Past Orders pane in the Orders page .....	128
Figure 148: Viewer option in the patient's profile page .....	128
Figure 149: Model in a 1-window view .....	129
Figure 150: Model in a 2-window view .....	130
Figure 151: Model in a 5-window view .....	130
Figure 152: Removing a wand sleeve .....	131
Figure 153: Optical surface of the wand .....	132
Figure 154: Gently slide the new sleeve into place .....	132
Figure 155: Patients page .....	133
Figure 156: Searching for a patient .....	134
Figure 157: Patients matching the search criteria are displayed .....	134
Figure 158: Patient's profile page .....	135
Figure 159: Patient's profile page – New Scan option .....	136
Figure 160: New Scan window with patient's details already filled in .....	137
Figure 161: Patient's profile page – View Rx option .....	138
Figure 162: Rx Details window .....	139
Figure 163: Patient's profile page – Viewer option .....	140
Figure 164: Scan displayed in the Viewer .....	140
Figure 165: Orders page .....	142
Figure 166: In Progress pane – options .....	142
Figure 167: Past Orders pane – options .....	143
Figure 168: Orders button notifying a returned order .....	144
Figure 169: Returned order in the In Progress pane .....	144

Figure 170: Messages page .....	145
Figure 171: iTero TimeLapse – selecting the scans to compare .....	148
Figure 172: iTero TimeLapse window showing the highlighted changes between the scans .....	148
Figure 173: Area of interest from the first scan displayed in the animation window .....	149
Figure 174: Area of interest from the second scan displayed in the animation window .....	149
Figure 175: iTero TimeLapse scale options .....	150
Figure 176: Progress Assessment window .....	152
Figure 177: Editing tools .....	153
Figure 178: Delete segment tool .....	154
Figure 179: Trim tool from the Scan window .....	155
Figure 180: Trim tool from the View window .....	156
Figure 181: Trim tool options .....	156
Figure 182: Mark the area to be trimmed away .....	157
Figure 183: Selected area is highlighted, and the confirmation icon is enabled .....	157
Figure 184: Selected area has been removed .....	158
Figure 185: Eraser tool .....	159
Figure 186: Mark the area to be modified .....	159
Figure 187: Selected area removed, and scan tool enabled .....	160
Figure 188: Deleted area to be rescanned .....	161
Figure 189: Disable auto-cleanup tool .....	162
Figure 190: Scan displayed with excess material showing .....	162
Figure 191: Enable Saliva Detection tool .....	163
Figure 192: Occlusal clearance between the opposing teeth .....	164
Figure 193: Occlusal Clearance range options .....	165
Figure 194: Occlusal Clearance tool and legend displayed in the Viewer .....	166
Figure 195: Green hint point centered on the prepped tooth .....	167
Figure 196: Die separation is displayed in high resolution .....	167
Figure 197: Die Separation tool options .....	168
Figure 198: Before selecting the die separation .....	168
Figure 199: Prepped tooth is displayed in high resolution .....	169
Figure 200: Model display moves to the occlusal view, and zooms in on the prepped tooth .....	170
Figure 201: Margin Line tool options .....	170
Figure 202: Margin line is marked on the prepped tooth .....	171
Figure 203: Margin Line tool options .....	172
Figure 204: Review tool with the loupe in the right pane .....	173

Figure 205: Image pane on the right showing the area of interest .....	173
Figure 206: Zoom-in button on the image in the image pane .....	174
Figure 207: Zoomed-in image displayed in the enlarged image pane .....	175
Figure 208: Brightness and contrast toolbar is collapsed .....	176
Figure 209: Brightness and contrast toolbar .....	176
Figure 210: View mode – with Snapshot tool .....	178
Figure 211: Screen capture thumbnail is displayed after taking a screen capture .....	178
Figure 212: Screenshot with an annotations toolbar .....	179
Figure 213: Annotations toolbar .....	179
Figure 214: Adding text to the screenshot .....	180
Figure 215: Screenshot with annotations .....	180
Figure 216: Notification that the screenshots and annotations will be uploaded to MyiTero .....	181
Figure 217: Confirmation about the annotations being discarded .....	181
Figure 218: Notification that the screenshots will be uploaded to MyiTero .....	182
Figure 219: Option to download screenshots from the Orders page in MyiTero .....	182
Figure 220: Wand without a sleeve .....	184
Figure 221: Remove gross contaminants using CaviWipes1 .....	185
Figure 222: Remove marks and stains using a soft bristle brush .....	186
Figure 223: Wipe the optical surface of the wand with IPA .....	187
Figure 224: Wiping the iTero Lumina cart-configuration cradle .....	188
Figure 225: Wiping the iTero Lumina mobile-configuration cradle .....	188
Figure 226: Brushing the iTero Lumina cart-configuration cradle .....	189
Figure 227: Brushing the iTero Lumina mobile-configuration cradle .....	189

# 1 Introduction to iTero Lumina™ intraoral scanners

The iTero Lumina™ family of imaging systems is Align Technology's latest generation of intraoral scanners, which comes in two configurations – cart and mobile.

The bright full HD touch-screen display has wide visualization angles for an immersive and engaging experience and the powerful computing power enables a smoother and intuitive scanning experience. The ergonomics and elegance of the cart configuration will enhance your experience and elevate your practice brand image. The mobile configuration, with its dedicated trolley, enables professional and convenient inter-office portability.

This all-in-one system is designed to take patient experience and your productivity to the next level, ultimately helping you to grow your practice while making things easier.

Refer to our website <http://www.itero.com> to learn how the iTero Service can enhance your business by increasing patient satisfaction and enhancing office efficiency.

## 1.1 Intended purpose/Intended use

iTero Lumina is an intraoral scanner intended to record and display the topographical images of teeth, oral tissue and bite relationship and to obtain optical impressions for use in CAD/CAM of dental devices.

## 1.2 Indications for use

iTero Lumina scans can be used for computer aided design and manufacturing of restorative dental devices\*, orthodontic devices and other dental devices such as night guards and bite splints.

Data generated from iTero Lumina may be used by dental healthcare professionals for assessing intraoral topographical images of hard and soft tissue and visual assessments. iTero Lumina does not treat or diagnose any disease.

## 1.3 Contraindications

For persons who have been diagnosed with Epilepsy, there is a risk of epileptic seizure from the flashing light of the iTero scanner.

## 1.4 Intended patient population

The system may be used on patients classified as Children\*, Adolescents, and Adults.

## 1.5 Intended users

The system serves as a prescription medical device and should be operated by trained dental health-care providers only.

## 1.6 Use environment

The system may be used in a Professional Healthcare environment.

## 1.7 Clinical benefits

Digital impressions improve patient comfort, accuracy, and speed of process as compared to conventional impressions.

---

\*Subject to regulatory or other required approvals and commercial availability in your country/region.

\*Children are defined as age 6 onwards, in this context.

## 1.8 iTero Lumina hardware

The iTero Lumina scanner is available in two configurations:

- [iTero Lumina cart configuration](#)
- [iTero Lumina mobile configuration](#)

### 1.8.1 iTero Lumina cart configuration

Front view

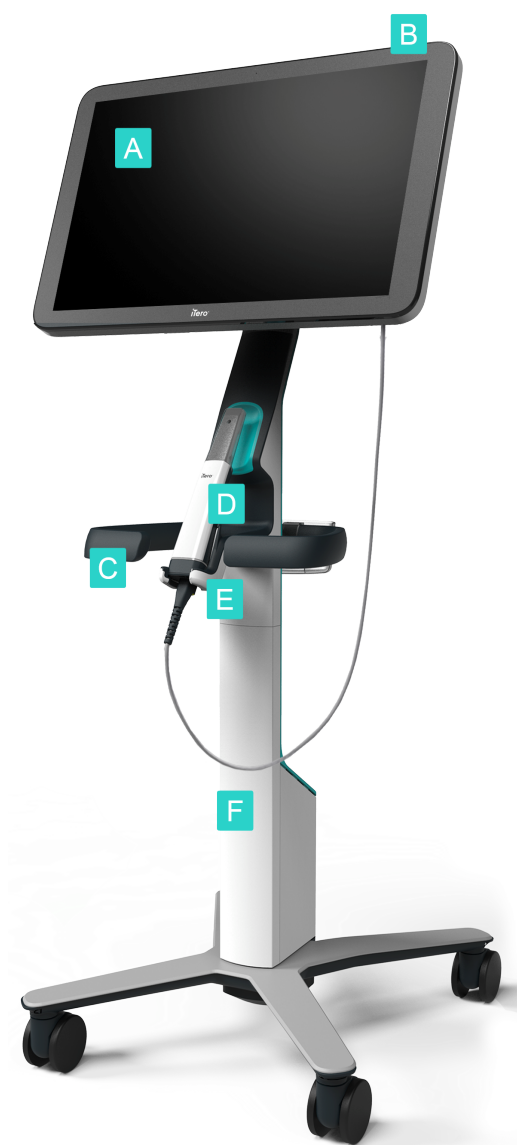

- A Full HD touchscreen
- B Power switch
- C Main handle
- D Wand
- E Cradle
- F Wheel stand

Figure 1: Front view of the iTero Lumina cart-configuration intraoral scanner

**Rear view**

- A Wand connector
- B Diagnostics panel  
(for Support purposes only)
- C Upper handle
- D New-sleeve basket

Figure 2: Rear view of the iTero Lumina cart-configuration intraoral scanner

**1.8.2 iTero Lumina mobile configuration****Front view**

- A Full HD touch-screen  
computing unit
- B Power button
- C Wand
- D Cradle

Figure 3: Front view of the iTero Lumina mobile-configuration intraoral scanner

Rear view

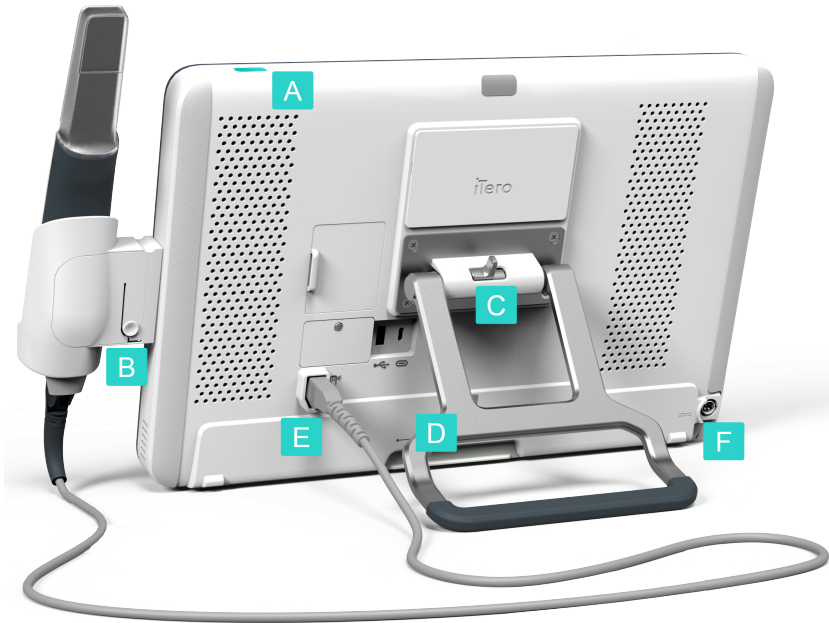

- A Power switch
- B Cradle release button
- C Locking latch
- D Carrying handle/stand
- E Wand cable
- F Power cable socket

Figure 4: Rear view of the iTero Lumina mobile-configuration intraoral scanner

### 1.8.3 iTero Lumina wand

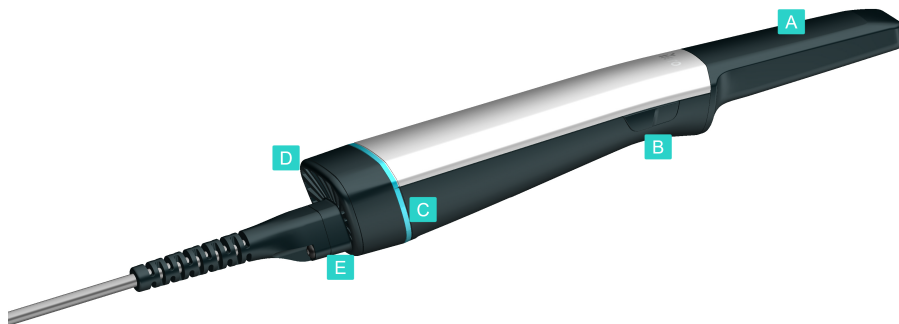

- A Protective sleeve
- B Side buttons: Scan on/off
- C Light ring
- D Air vents
- E Wand cable with USB connector

Figure 5: iTero Lumina wand

### 1.8.3.1 Wand sleeves

iTero Lumina sleeves are suitable for the iTero Lumina family of products. They are a single-use disposable component intended for use as a cover to the iTero Lumina scanner wand to reduce the risk of cross-contamination during the scanning procedure and to protect the optical window of the wand.

There are two types of wand sleeves:

- **Protective sleeve (dark):** Used when the scanner is not in use, to protect the optical surface of the wand.
- **Disposable sleeve:** Used while scanning. Before scanning the patient, attach a new disposable sleeve, as described in [Applying a sleeve](#).



Figure 6: Protective sleeve

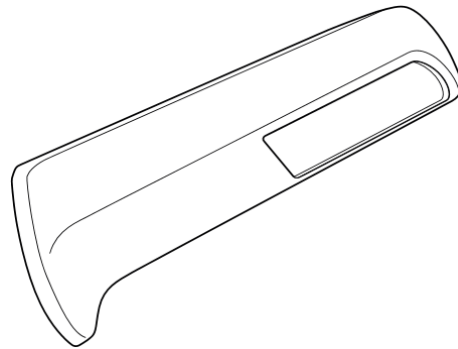



Figure 7: Disposable sleeve

### 1.8.3.2 Working with the iTero Lumina wand

After being switched on, the iTero Lumina system requires approximately 7 minutes to warm up before initial use. The LED light ring at the base of the wand indicates the state of the wand.

The wand can be in one of the following states:

- **Off** - The wand light ring is turned off.
- **Warming up/Initializing** - The LED light ring flickers slowly (pulsates) while the system is warming up. When you move to Scan mode, a  icon is displayed on the toolbar and the progress of the initialization is displayed. This takes approximately 7 minutes.
- **Standby/Ready/Scanning/Sending** - The LED light ring is turned on and is constant.
- **Maintenance** - The LED light ring flickers quickly indicating that maintenance is in progress. The *Login* page is displayed once the maintenance is complete.
- **Error** - The LED light ring flickers quickly and an error message is displayed on the screen.

To switch the wand on or off when in an active scan, firmly press one of the side buttons on the wand. A sound is emitted indicating that scanning has started or stopped. You can control the volume, as described in [Defining the default volume setting](#).

The wand should always be placed in the cradle with the cable positioned at the base and the optical window facing the cradle (away from you). If the wand is incorrectly placed in the cradle, a message is displayed, prompting you to check the wand placement.

## 1.9 About this manual

This manual provides general information and an overview of the iTero Lumina intraoral scanners and software.

In addition, this manual describes how to assemble the system, start and shut down the system, clean and disinfect the system, and how to replace the sleeves between patients.

**Disclaimer:** All screenshots displayed in this manual are for illustration purposes only and may differ on your scanner depending on the version of the software installed and your iTero subscription package.

## 2 Assembly instructions

This section describes how to assemble your new scanner.

- [Assembling the iTero Lumina scanner – cart configuration](#)
- [Assembling the iTero Lumina scanner – mobile configuration](#)

### 2.1 Assembling the iTero Lumina scanner – cart configuration

The scanner packaging is designed in a way that provides a simple and easy assembly process.

Follow the instructions below to assemble the scanner.

Contact iTero Support for additional help.

- A** 2x Allen keys  
(in the white foam on top of the post)
- B** Post
- C** Wheel base
- D** Main handle  
(in the accessory box)
- E** New-sleeve basket  
(in the accessory box)
- F** Upper handle  
(in the accessory box)
- G** Full HD touch-screen computing unit
- H** Cradle
- I** Wand
- J** Power cable
- K** Webcam
- L** Power switch

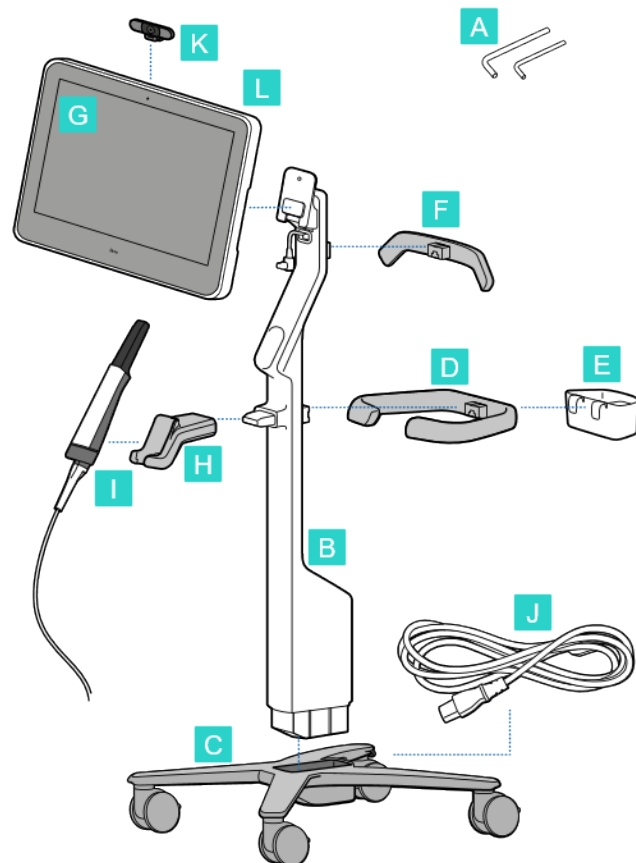

**Note:** If any damage to the system or accessories is found, do not assemble or use the scanner and contact iTero Support.

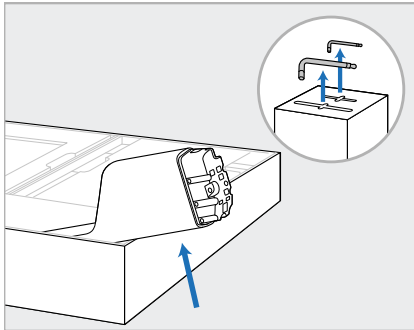

1. Remove all Styrofoam coverings from the box.  
**Note:** The two Allen keys (A) are on top of the Styrofoam covering the post (B).
2. Lift the post (B), pull it out slightly, and rest it on the side of the box.

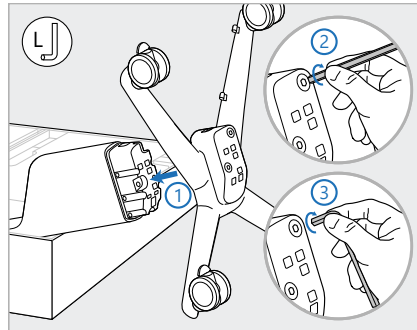

3. Attach the wheel base (C) to the end of the post (B) and tighten using first the longer side of the large Allen key and then the shorter side.

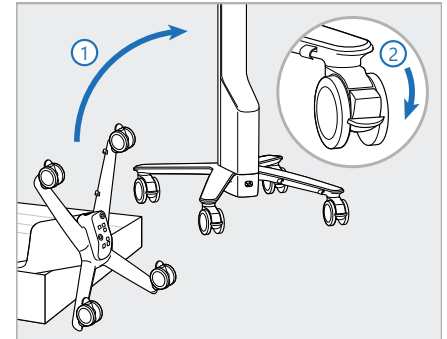

4. Move the wheel stand to an upright position and lock at least two wheels.

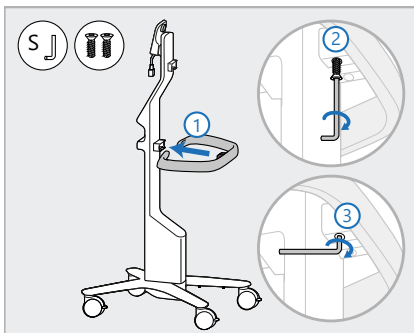

5. Remove the main handle (D) and the two screws from the accessory box. Attach the main handle and tighten using first the longer side of the small Allen key and then the shorter side.

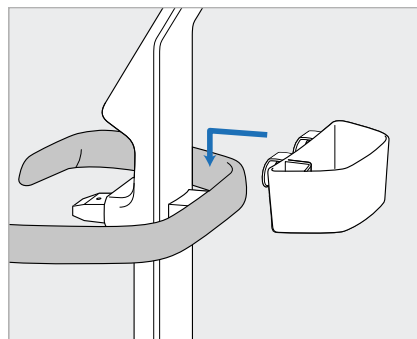

6. Remove the sleeve basket (E) from the accessory box and place it on the back of the main handle (D).

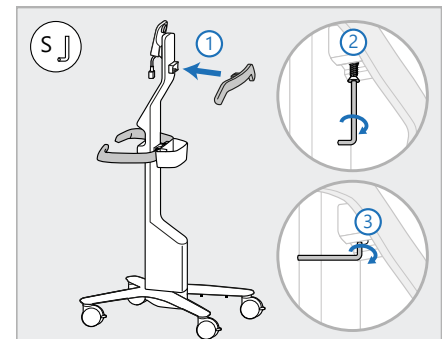

7. Remove the upper handle (F) from the accessory box and remove the pull tab to access the screw.
8. Attach the upper handle (F) to the post (B) and tighten using first the longer side of the small Allen key and then the shorter side.

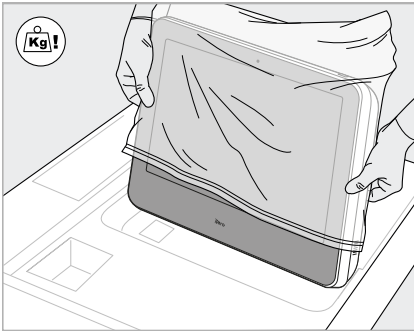

9. Carefully remove the computing unit (G) from its protective wrapping.  
**Note:** The computing unit is heavy and must be lifted carefully.

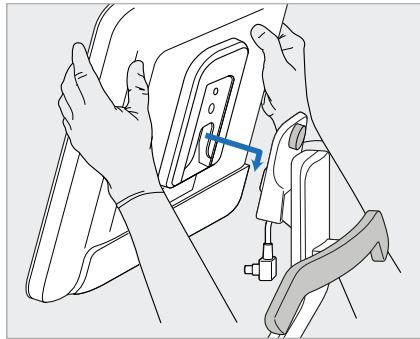

10. Standing behind the wheel stand, mount the computing unit (G) on the metal hinge and push down.  
**Note:** Make sure the computing unit does not press on the screen cable. If it does, move the cable to the side.

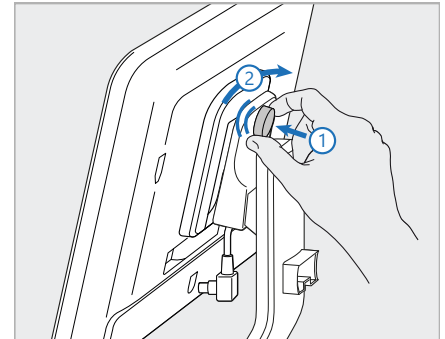

11. Attach the computing unit (G) by pushing in and tightening the screw.

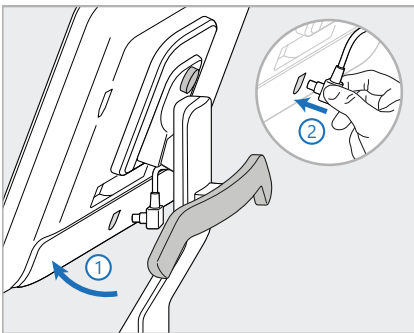

12. If the cable connector is covered, remove the cover.  
 Tilt the screen upwards and connect the screen cable.

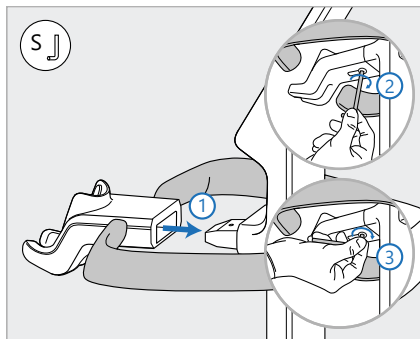

13. Attach the cradle (H) to the post (B) and tighten using first the longer side of the small Allen key and then the shorter side.

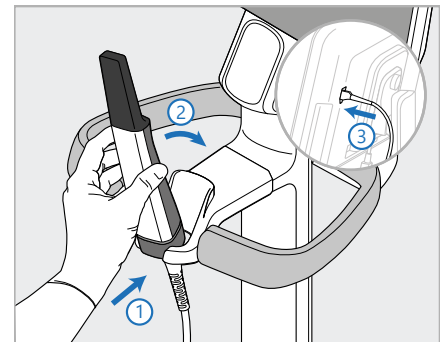

14. Insert the base of the wand (I) in the cradle (H) and then apply gentle pressure to make sure the wand is fully inserted and secure in the cradle.  
 15. Connect the wand cable to the back of the screen (G).

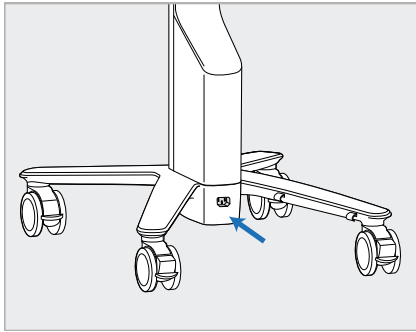

16. Connect the power cable (J) to the bottom of the wheel stand.

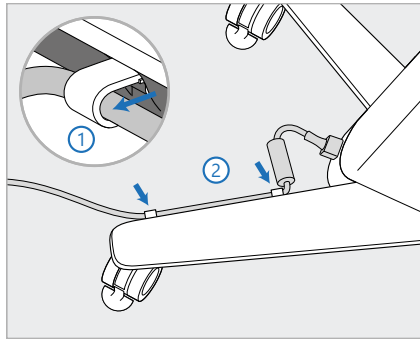

17. Secure the power cable (J) in the two cable clips, making sure it is fully inserted.

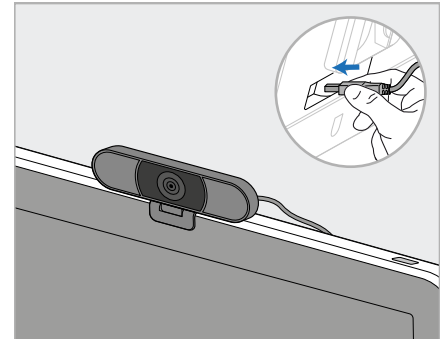

18. For remote training sessions, position the webcam (K) on the screen and then connect it to the USB port at the back of the screen.

**Note:** The webcam must be disconnected after each training session.

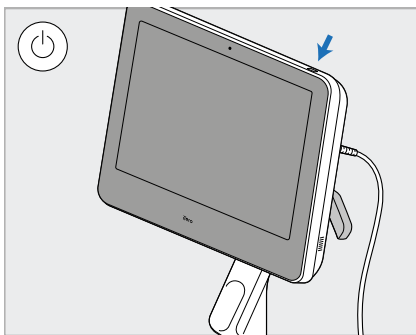

19. Plug the power cable (J) into a power outlet and then press the Power button (L) to switch on the scanner.

#### Notes:

- The webcam lens should be covered when the webcam is not actively in use.
- Always return the wand to the cradle after each use.
- When the system is not in use, the wand should be placed in the cradle with the optical window facing the cradle.
- The wand, cradle, and other system components should be cleaned and disinfected immediately after each patient, as described in [Care and maintenance](#).
- Ensure that the scanner is positioned in a location where it can easily be disconnected from the power outlet.

To remove the wand from the cradle, first pull the upper part of the wand towards you and then gently remove it from the cradle.

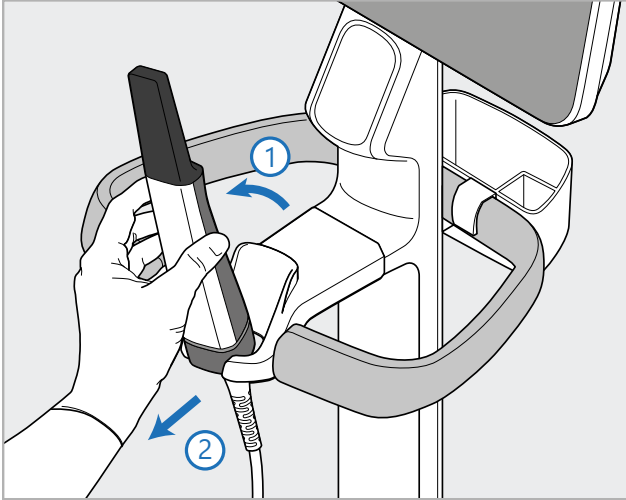

Figure 8: Removing the wand from the cradle

When moving the scanner, carefully wrap the power cable around the upper handle and then use the upper handle to push the scanner.

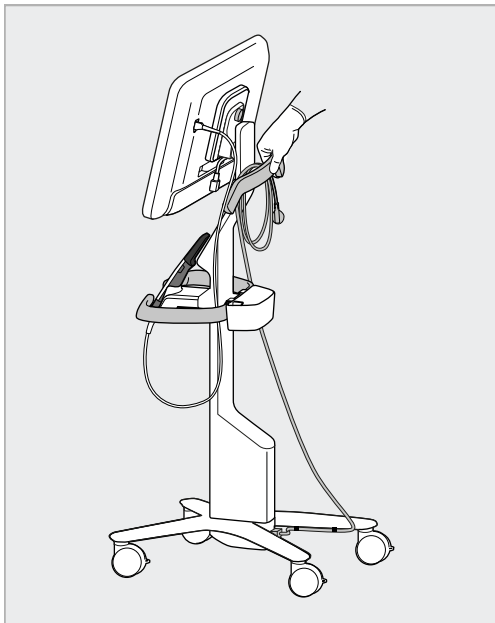

Figure 9: Moving the scanner

If the scanner needs to be lifted, use the upper handle and the post.

**Do not** use the main handle to lift the scanner.

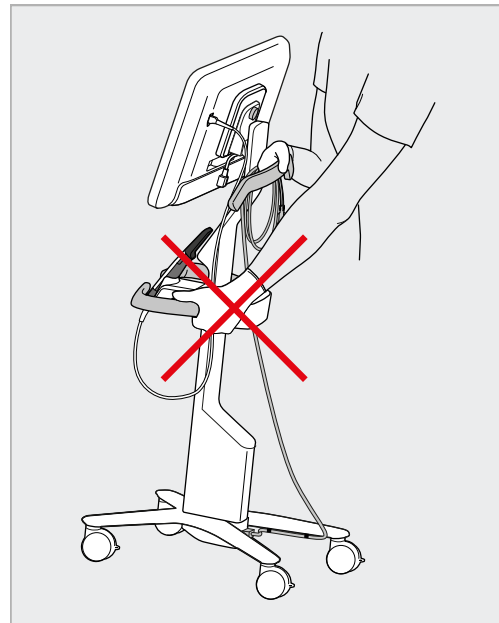

Figure 10: Do not lift the scanner using the main handle

## 2.2 Assembling the iTero Lumina scanner – mobile configuration

The scanner packaging is designed in a way that provides a simple and easy assembly process.

Follow the instructions below to assemble the scanner.

Contact iTero Support for additional help.

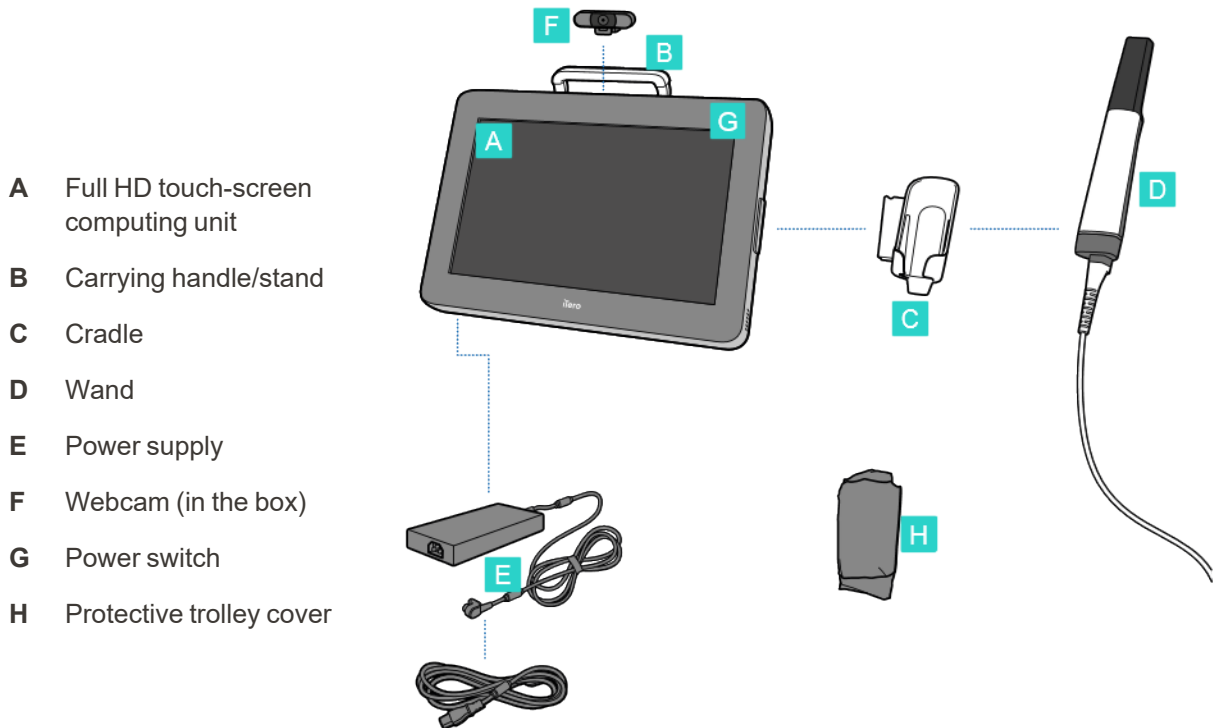

**Note:** If any damage to the system or accessories is found, do not assemble or use the scanner and contact iTero support.

This section describes:

- [Initial assembly](#)
- [Moving the scanner within the clinic](#)
- [Using the trolley for transportation](#)
- [Optional protective trolley cover](#)
- [VESA mounting](#)

2.2.1 Initial assembly

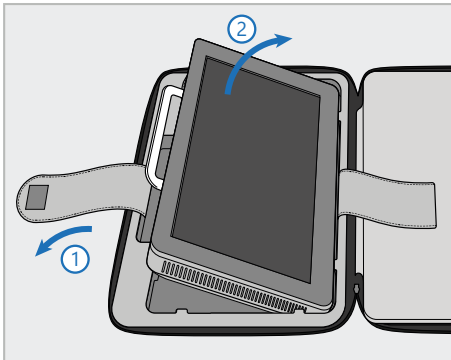

1. Undo the strap holding the computing unit (A), and then remove it using the handle (B).

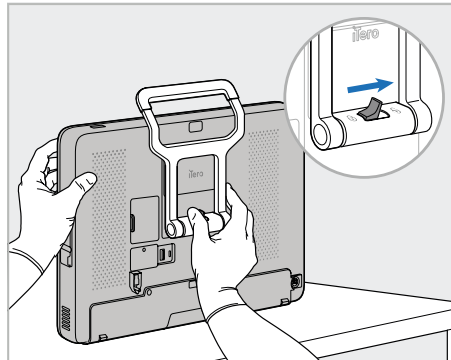

2. Rest the computing unit (A) on a smooth, flat surface and hold it with one hand. While holding the computing unit, slide the locking latch to the right until you feel a click, to unlock the handle (B).

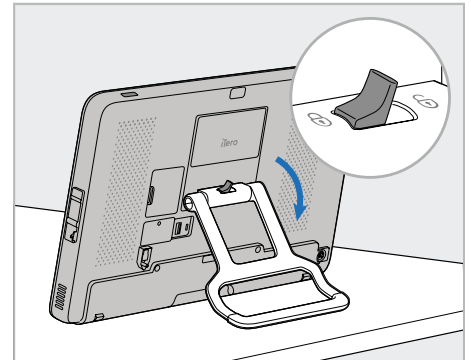

3. Move the handle (B) down to the standing position. Ensure that the handle is securely locked in place by trying to pull it back up.

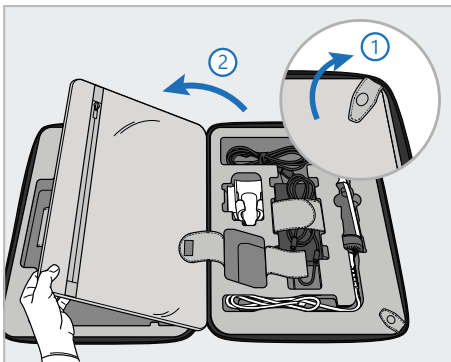

4. Undo the snaps and open the flap to remove the rest of the scanner components.

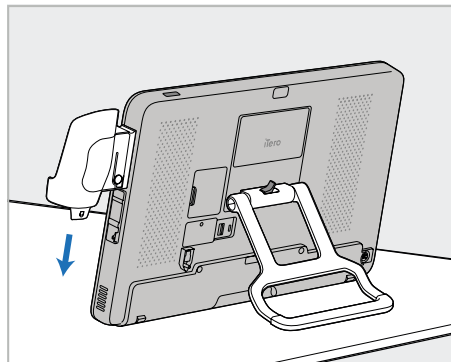

5. Slide down the cradle (C) on the slider on the side of the computing unit (A) until it clicks into place. Make sure the cradle is secure and cannot be removed.

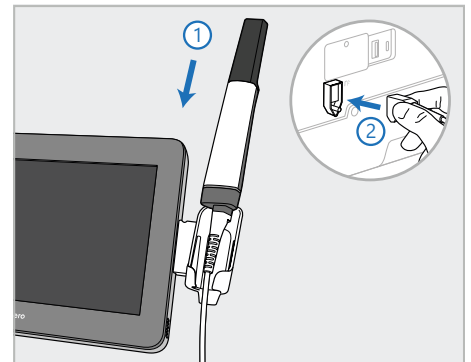

6. Place the wand (D) in the cradle (C) and connect the wand cable to the port marked  at the back of the computing unit (A).

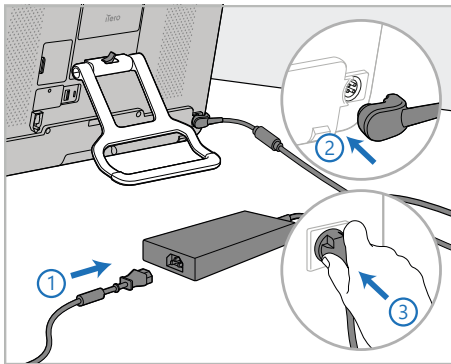

7. Connect the power cable to the power supply (E). Afterwards, connect one side of the cable to the back of the computing unit (A) and the other side to a power outlet.

**Note:** Place the cable in a safe manner so that no one is likely to accidentally trip over it.

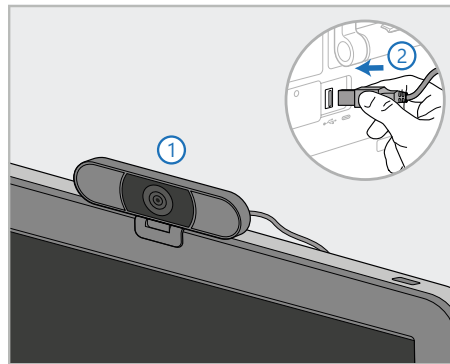

8. For remote training sessions, position the webcam (F) on the computing unit (A) and then connect it to the USB port at the back of the computing unit.

**Note:** The webcam is packed in the scanner box.

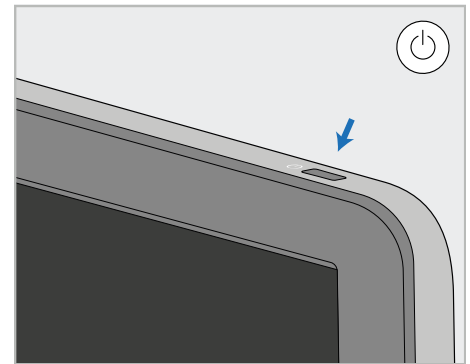

9. Press the power button (G) to turn on the scanner.

#### Notes:

- The webcam must be disconnected after each training session.
- The webcam lens should be covered when the webcam is not actively in use.
- Always return the wand to the cradle after each use.
- When the system is not in use, the wand should be placed in the cradle with the optical window facing the cradle.
- The wand, cradle, and other system components should be cleaned and disinfected immediately after each patient, as described in [Care and maintenance](#).
- Ensure that the scanner is positioned in a location where it can easily be disconnected from the power outlet.

### 2.2.2 Moving the scanner within the clinic

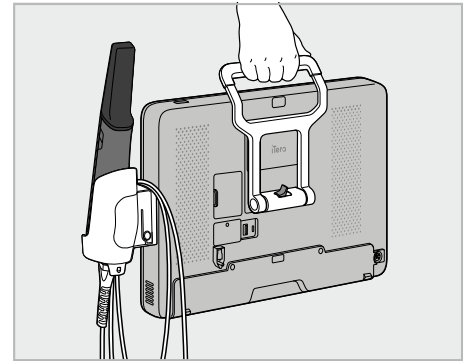
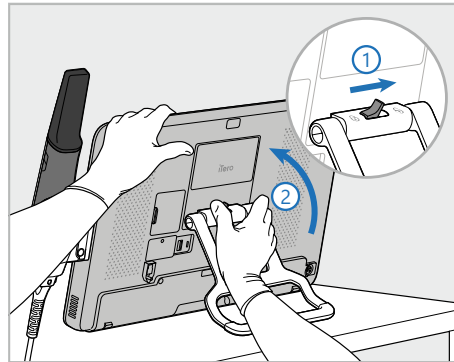
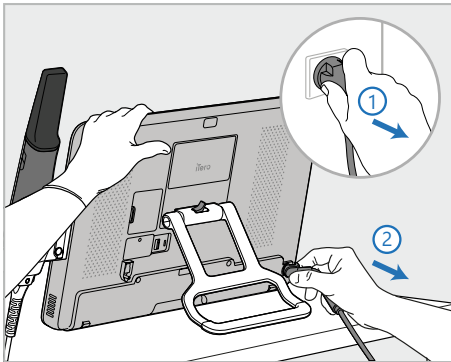

1. Ensure that the wand (D) is firmly positioned in the cradle (C).
2. Disconnect the power cable (E) from the mains and then from the back of the computing unit (A).
3. While holding the computing unit (A) with one hand, slide the locking latch to the right to unlock the handle (B) and then move the handle to the carrying position.
4. Loosely wrap the wand cable around the cradle (C) for easy and safe portability.

### 2.2.3 Using the trolley for transportation

Before transporting the scanner, it must be packed into the supplied trolley.

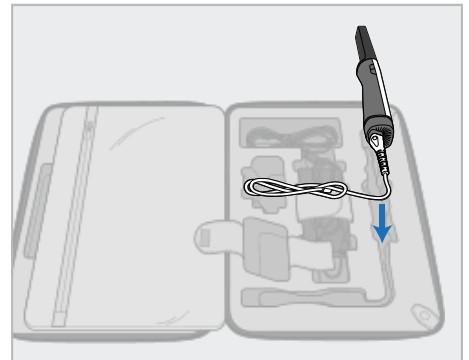
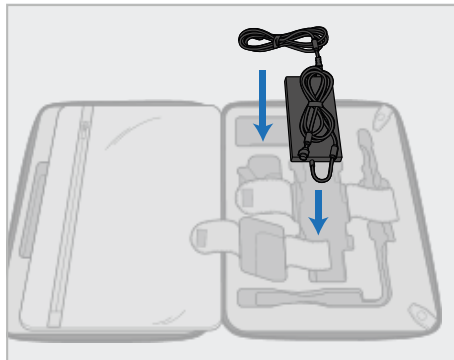
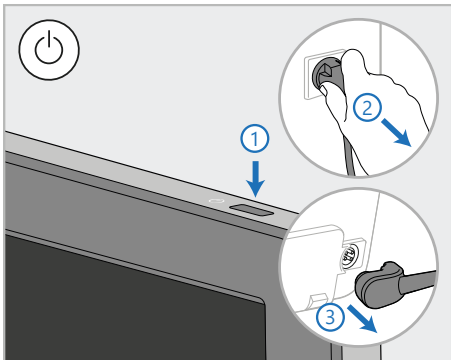

1. Turn off the scanner and disconnect the power cable (E) from the mains and then from the back of the computing unit (A).
2. For easier packing, start by placing the power pack (E) in its designated compartment in the trolley. Wrap the thinner part of the cable and place it on top of the power supply, and then wrap the thicker part of the cable and place it in its compartment in the trolley.
3. Disconnect the wand (D) and place it in its compartment in the trolley.

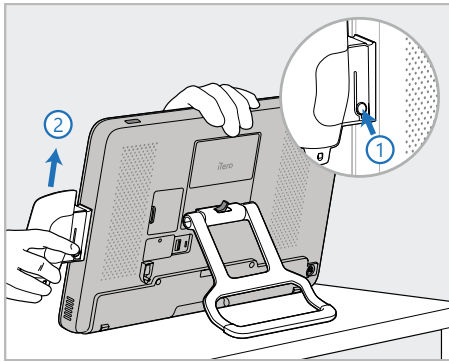

4. While holding the computing unit (A) with one hand, remove the cradle (C) by pressing the release button and pulling up the cradle.

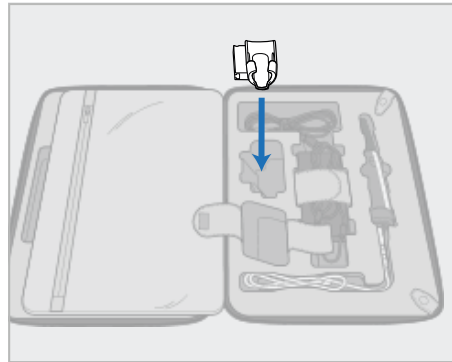

5. Place the cradle (C) in the trolley.

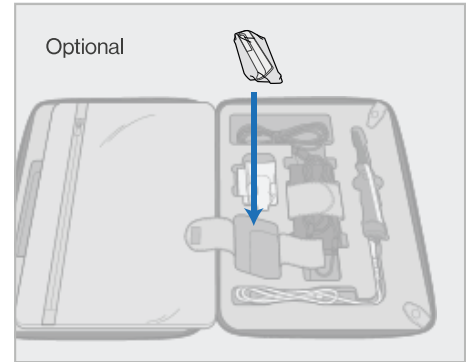

6. Optional: Place new sleeves in the compartment next to the cradle (C), instead of the protective trolley cover (H).

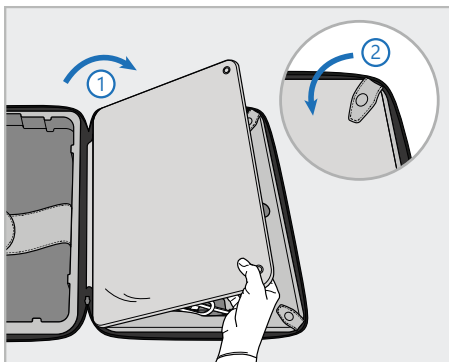

7. Move the flap to cover the scanner components and then secure the flap with the snaps.

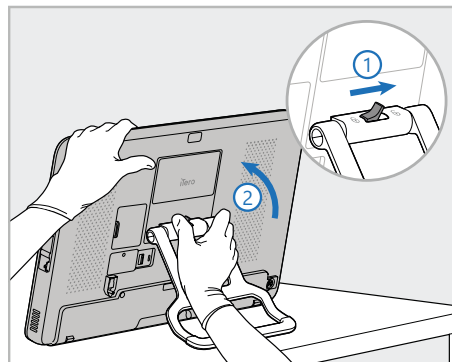

8. Slide the locking latch to the right to unlock the stand (B) and then move it to the carrying position.

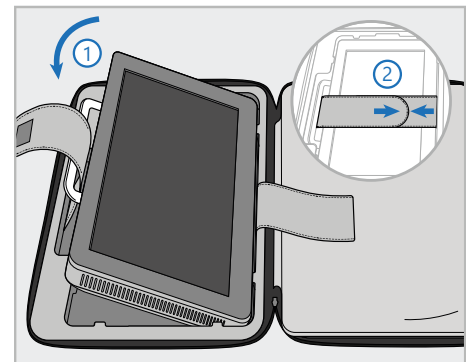

9. Place the computing unit (A) in its compartment in the trolley. Thread the outer strap through the handle (B) and close the straps to ensure that it is held securely in place.

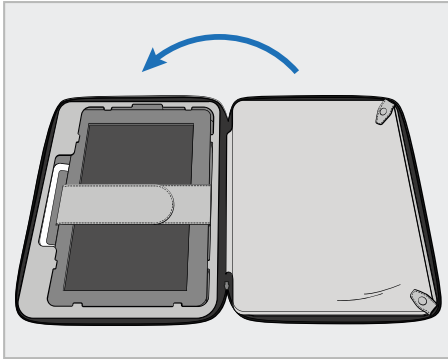

10. Close the trolley by lifting the side with the fastened flap and then zipping it closed.

You are now ready to travel with your scanner.  
If required, you can use the optional protective trolley cover (H), described in [Optional protective trolley cover](#).

**Notes:**

- The trolley must be handled with care.
- Avoid leaving the trolley in the sun in order to prevent the scanner from reaching extreme temperatures.
- Make sure the trolley is kept dry to protect the system components from humidity.
- If the scanner has just been brought into the office from a hot, cold, or humid environment, it should be set aside until it has adjusted to room temperature, to avoid internal condensation.
- Do not check the trolley as baggage when traveling by air, to reduce the risk of damage to the scanner that may be caused by uncontrolled transportation conditions.

## 2.2.4 Optional protective trolley cover

The trolley is supplied with an optional protective cover that helps protect it against wear and tear and adverse weather conditions.

**Note:** The protective cover provides a certain level of protection against rain, but is not waterproof.

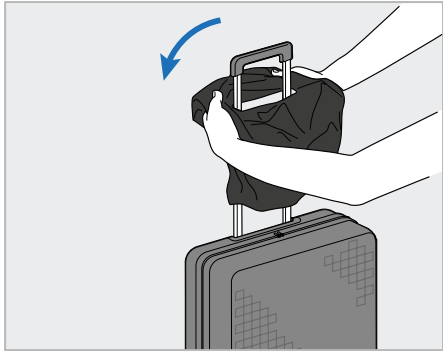

1. Open the VELCRO® flap and slip the protective cover (H) over the trolley handle.

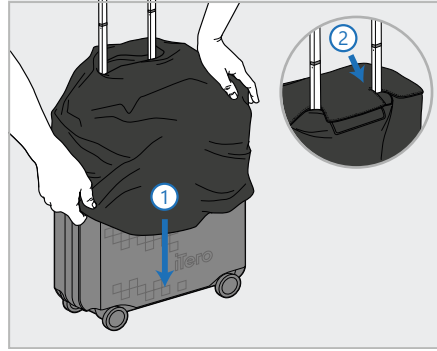

2. Pull down to cover the trolley and then close the VELCRO® flap.

## 2.2.5 VESA mounting

The scanner provides a standard 100mm VESA mounting interface that can be used for mounting it using 3rd party VESA-based mounting solutions.

### Notes:

- **Ensure that the selected VESA mounting solution supports the following scanner specifications:**
  - VESA 100mm
  - Minimum weight: 6kg (including the computing unit, wand, and cradle).  
Recommended weight: 9kg.
- If the scanner has already been assembled, you must remove the power cable and the cradle, as described in [Using the trolley for transportation](#).
- We recommend that connecting the computing unit to the VESA mount, step 3 below, be performed by two people.

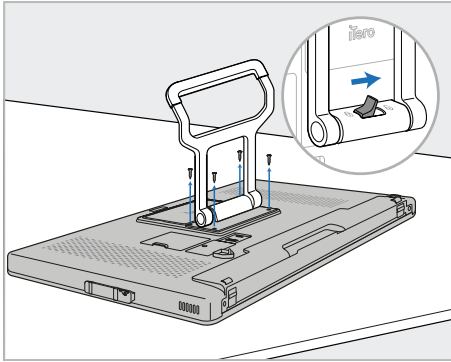

1. Lay the computing unit (A) face down on a smooth, flat surface.  
Remove the 4 screws with a Phillips screwdriver, while holding and moving the handle (B), as required.

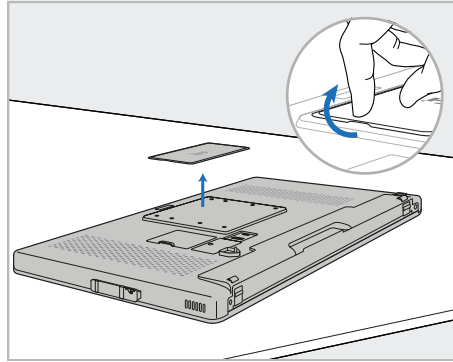

2. Remove the iTero back cover plate to expose the VESA screw holes. (It is recommended to store the cover plate and screws in the trolley.)

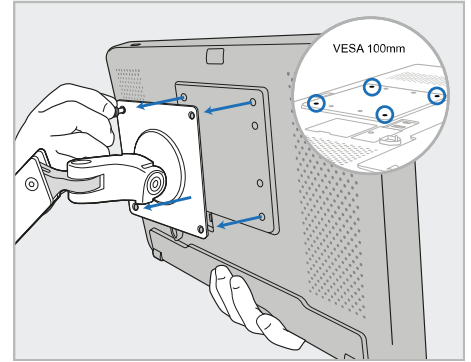

3. Connect the computing unit (A) to the external VESA mount (VESA 100) using the screws supplied with the mounting solution.  
Optional: You can purchase a 3m power cable from Align, if required.

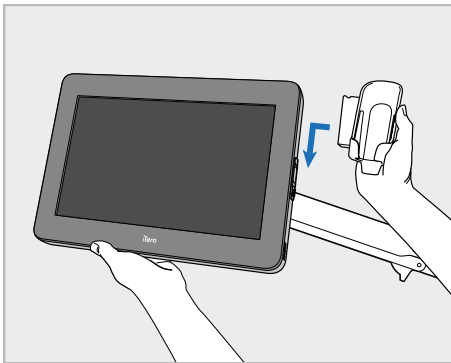

4. While supporting the computing unit (A) with one hand, slide the cradle (C) on the slider on the side of the computing unit until it clicks into place.  
Make sure the cradle is secure and cannot be pulled off.

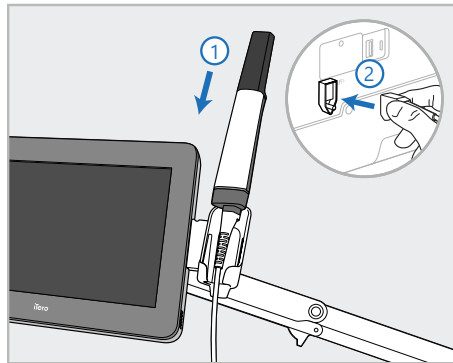

5. Place the wand (D) in the cradle (C) and connect the wand cable to the port marked **A** at the back of the computing unit (A).

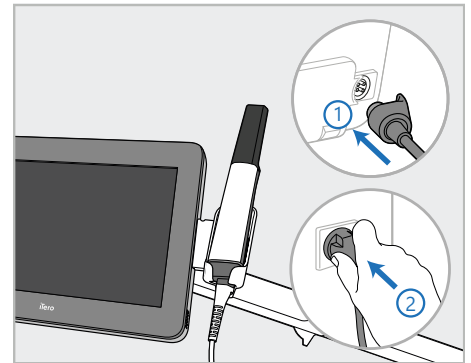

6. Connect the power cable (E) to the back of the computing unit (A) and then to the mains.

**Notes:**

- Ensure that the power pack rests on the floor or on a table and does not dangle in the air.

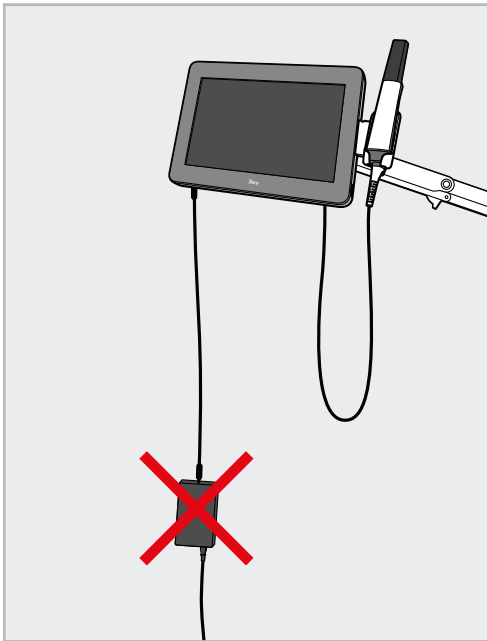

Figure 11: Do not allow the power pack to dangle in the air

- Never tilt the screen more than 45 degrees to make sure that the wand does not slip out of the cradle.

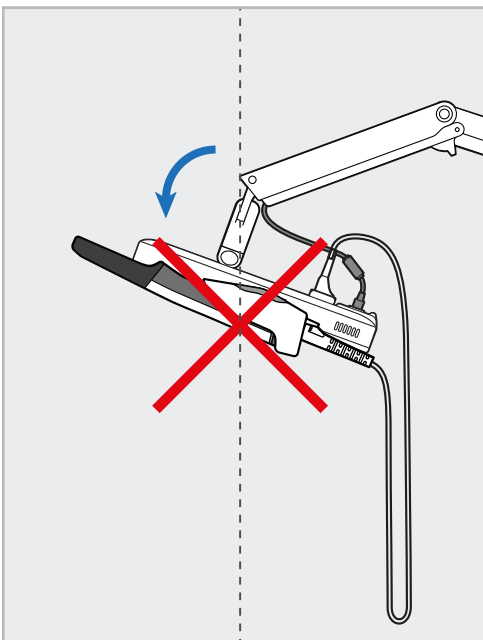

Figure 12: Never tilt the screen more than 45 degrees

## 3 Getting started

### 3.1 Logging in to the scanner for the first time

When you turn on the scanner for the first time, the *Welcome* screen is displayed:

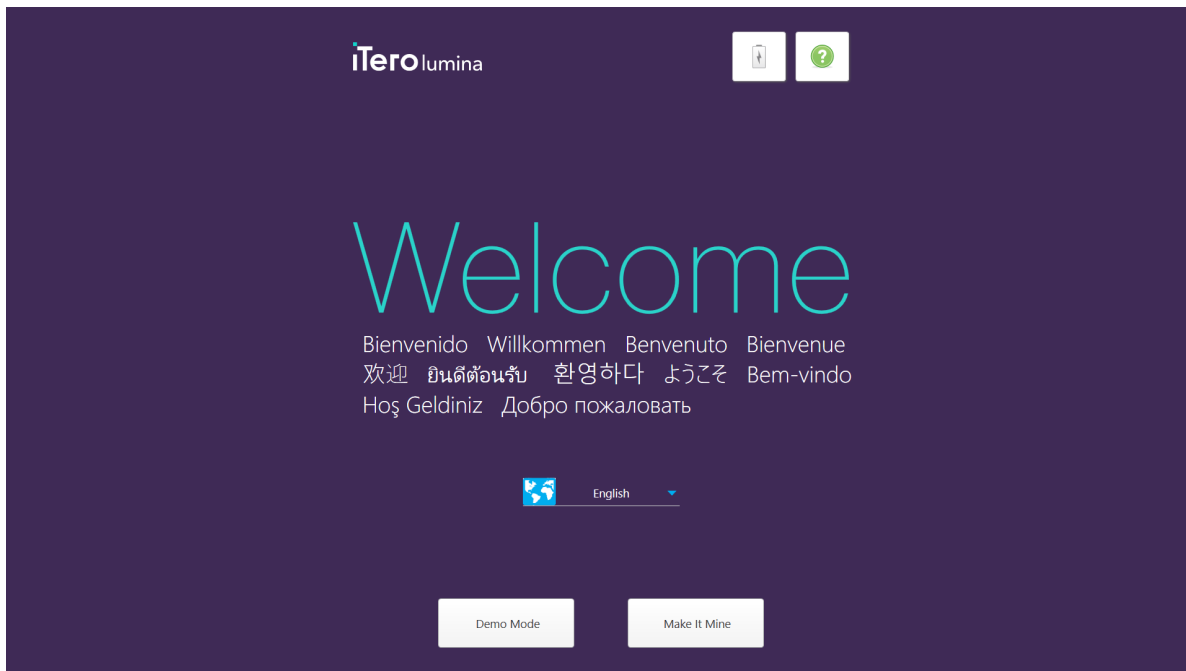

Figure 13: Welcome screen

Select the required language and one of the following modes:

- **Make It Mine:** Enables you to register the scanner. For more information, see [Registering the scanner – Make It Mine process](#), below.
- **Demo Mode:** Enables you to familiarize yourself with the scanner’s features and perform practice scans without submitting the scans. For more information, see [Working in Demo Mode](#).

**Note:** If you select the **Demo Mode** option before registering the scanner (**Make It Mine** option), you will have to restart the scanner to access the **Make It Mine** option.

### 3.2 Registering the scanner – Make It Mine process

When registering the scanner, you need the following details to complete the registration process:

- User Name
- User Password
- Company ID

You will receive an email from an iTero representative with login credentials and detailed information on how to proceed with the **Make It Mine** process.

**To register the scanner:**

1. In the *Welcome* page, select the required language.
2. Tap **Make It Mine**.

The *Connect* page is displayed, showing a list of available networks.

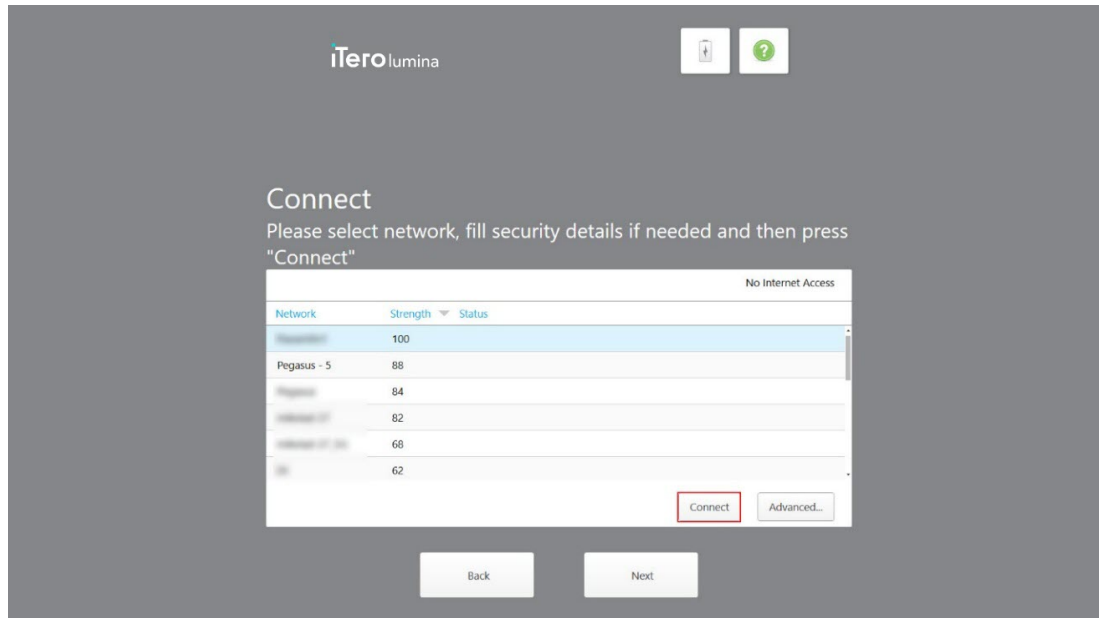

Figure 14: Connect page listing the available networks

3. Select the clinic network from the list and then tap **Connect**.

You are prompted to enter the network security key.

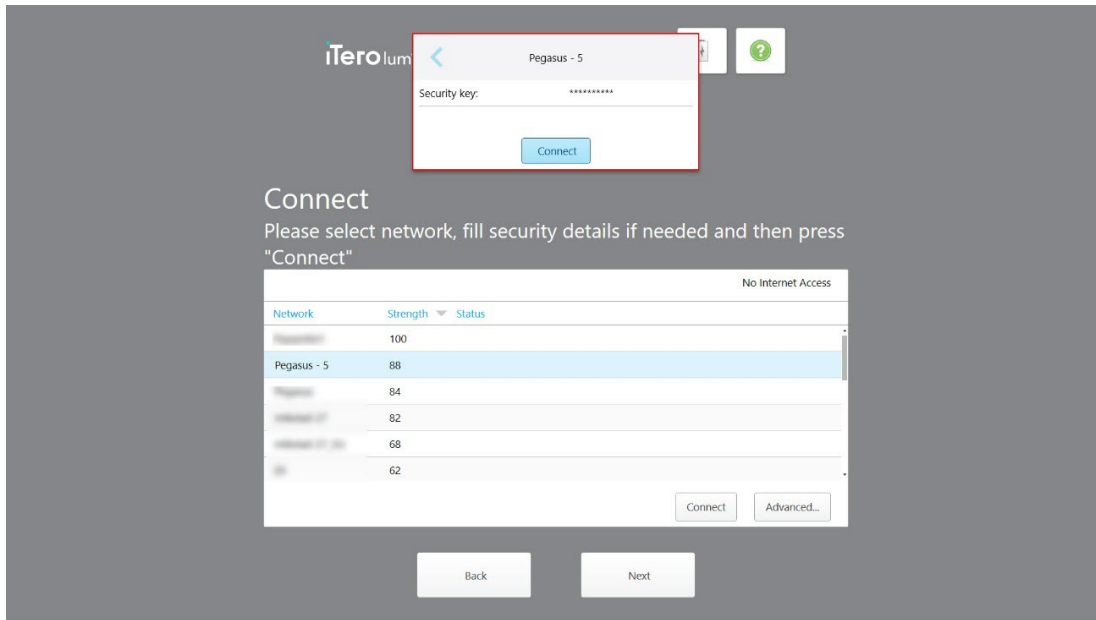

Figure 15: Entering the security key

4. Enter the security key and then tap **Connect**.

The scanner is now connected to the Internet and online.

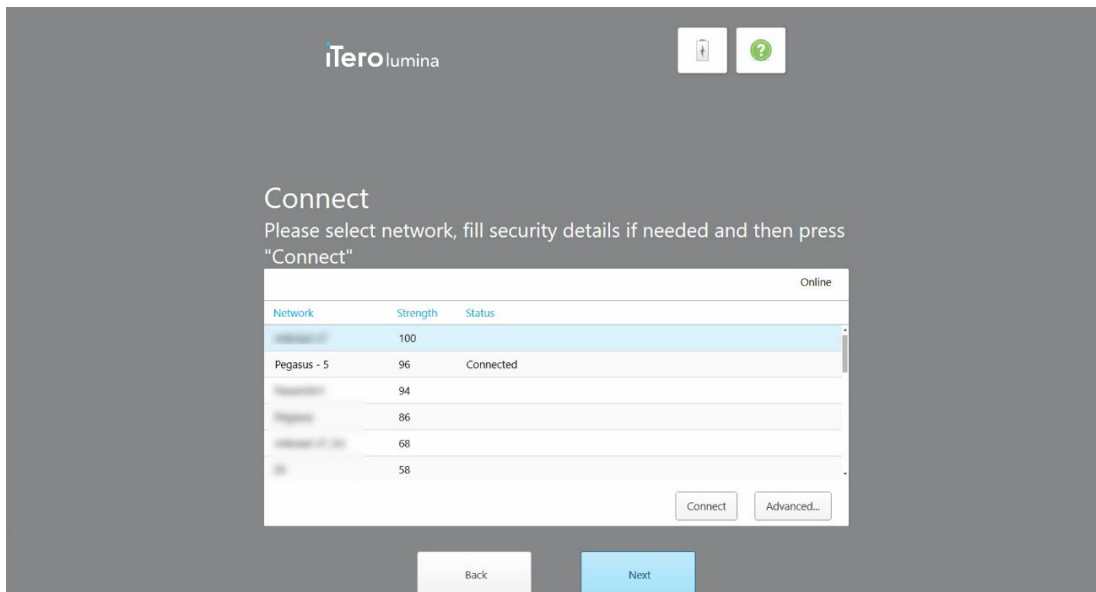

Figure 16: Scanner is connected to the Internet and online

5. Tap **Next**.

The communication with Align is verified.

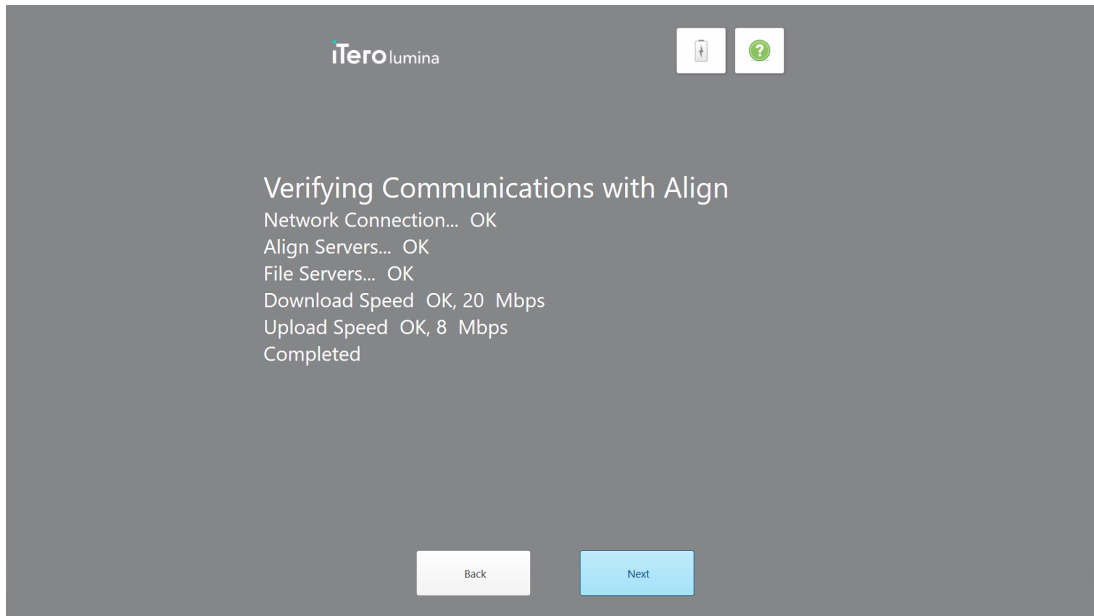

Figure 17: Verifying the communication with Align

6. When the verification is complete, tap **Next**.

The *Time Zone* page is displayed.

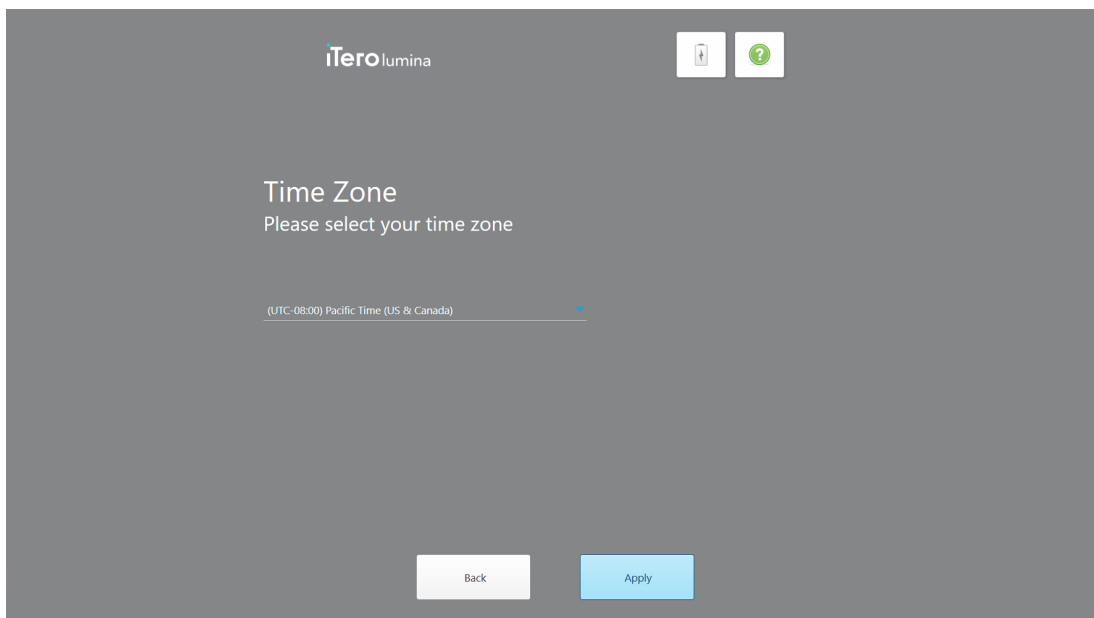

Figure 18: Selecting the time zone

7. Tap **Next** if the default time zone is correct or select the time zone from the drop-down list and then tap **Apply**. The *Register System* page is displayed.

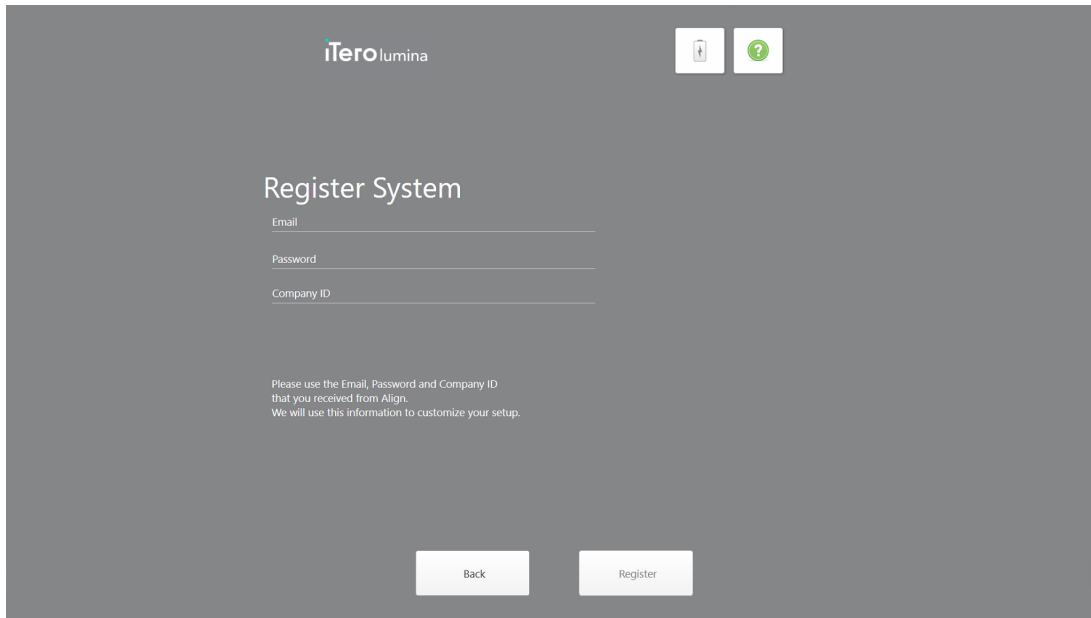

Figure 19: Registering the system to customize the setup

8. Enter your email, password, and company ID in the fields provided. Tap **Register** and then tap **Next** after the system has been registered.

The *Scanner Configuration* page is displayed, showing your iTero subscription package.

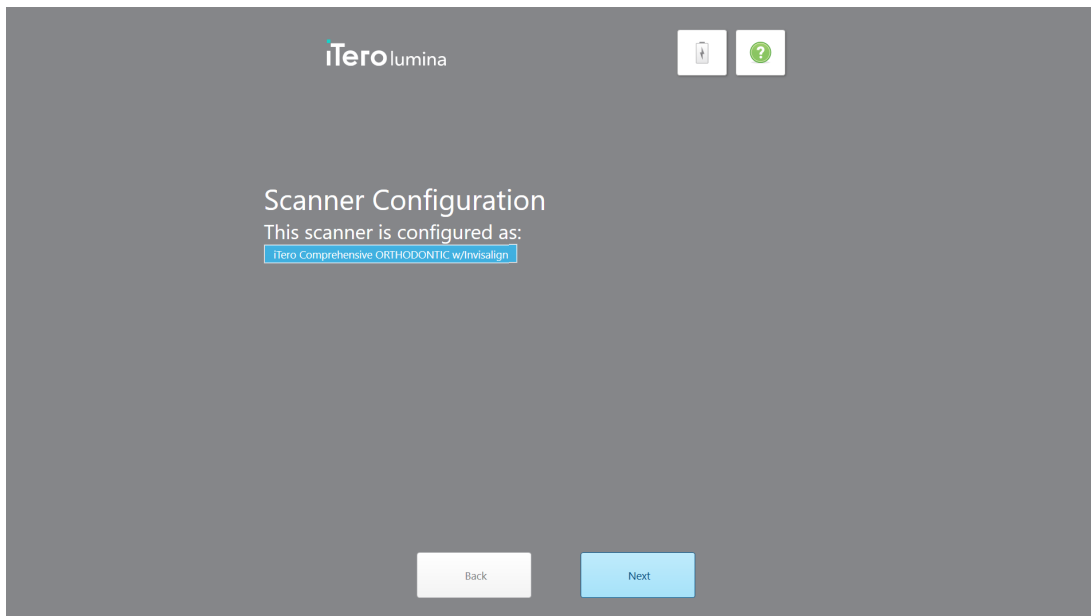

Figure 20: Example of an iTero subscription package

9. Tap **Next**.

The *License Agreement* page is displayed.

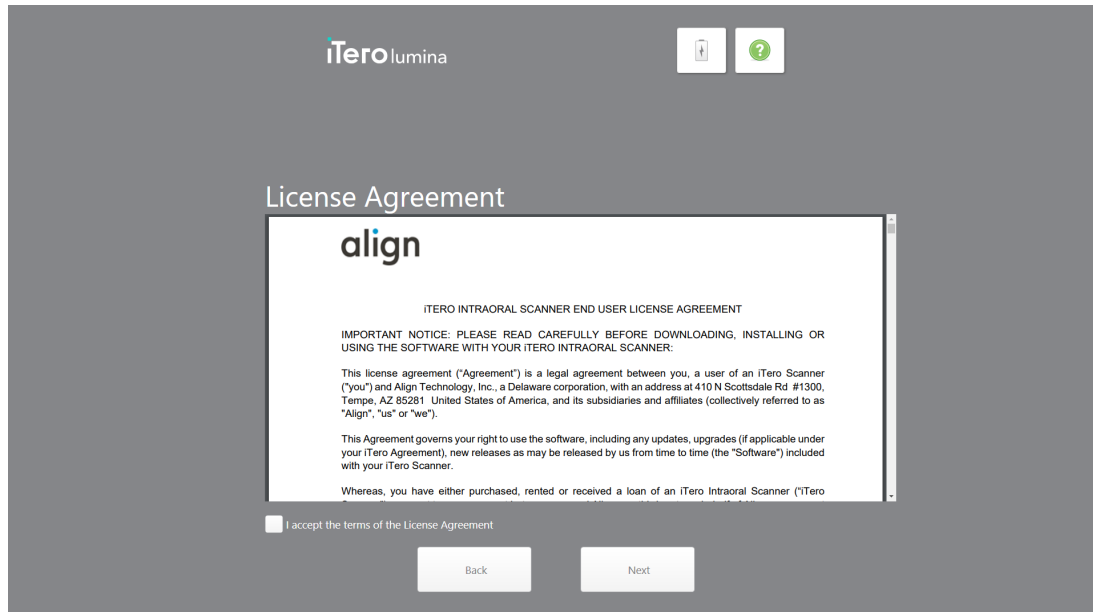

Figure 21: License agreement

10. After reviewing the license agreement, select the check box to accept the terms of the agreement and then tap **Next**.

The system checks for an upgrade and is upgraded to the latest version, if relevant.

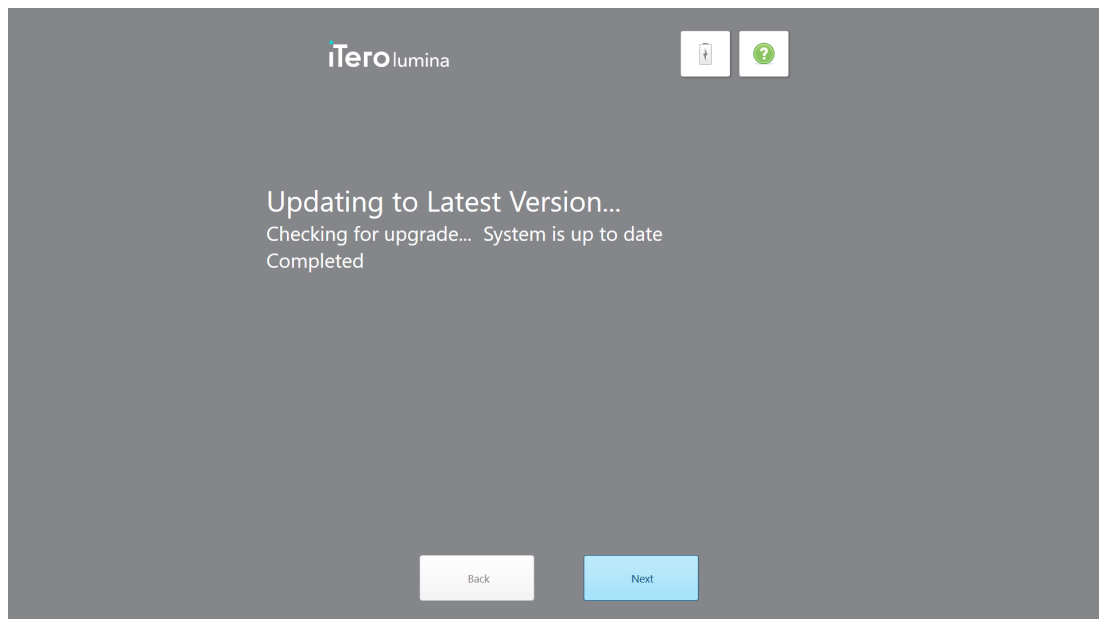

Figure 22: Checking for updates

11. Tap **Next**.

The system has been registered and is ready.



Figure 23: System is registered and ready

12. Tap **Login to iTero Lumina** to log in to the system.

The *Login* window is displayed. For more information on logging in to the system, see [Logging in to the scanner](#).

### 3.3 Working in Demo Mode

Demo Mode is designed for training new staff members and for practicing scanning. It is available anytime for training on an iTero scanner, for scanning techniques, how-to guidelines for prescription forms, procedures and procedure types, and to familiarize yourself with the iTero interface. Demo Mode features all the aspects of the scanning process and includes a wide variety of sample cases, including clinical cases, Invisalign | Viverra cases, and restorative cases.

The words **Demo Mode** are displayed in red on the top left of the screen to indicate that you are in Demo Mode, and when scanning, a lightly striped background is displayed.

**Note:** Scans captured in Demo Mode cannot be saved or submitted for patient treatment.

Demo Mode is available from the *Welcome* screen when logging in for the first time, or at any point by tapping the iTero logo on the home screen.

**To enter Demo Mode after logging in:**

1. Tap the iTerO Lumina logo at the top of the scanner screen.

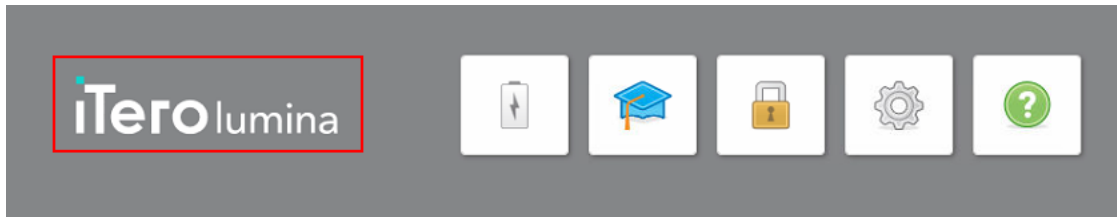

Figure 24: iTerO Lumina logo

2. Tap **Demo Mode**.

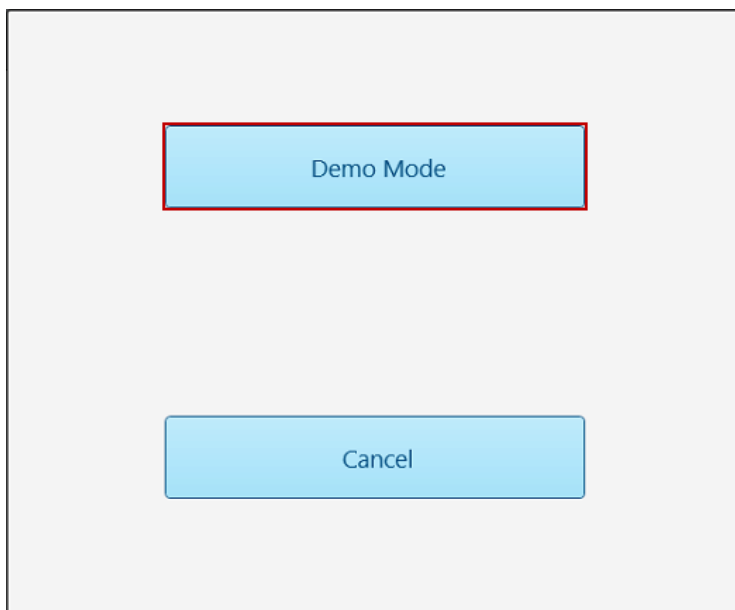
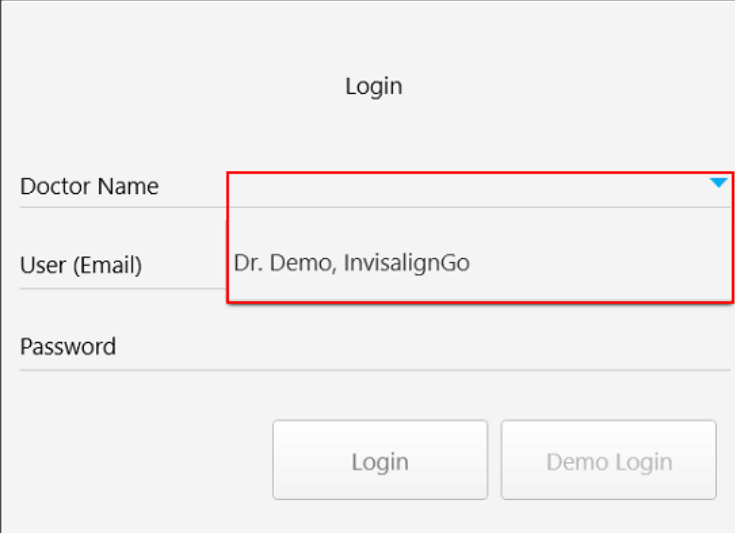

Figure 25: Demo Mode option

The *Login* window is displayed, enabling you to select the demo user.



The screenshot shows a 'Login' window with the following fields and buttons:

- Doctor Name:** A dropdown menu with a blue arrow on the right. A red box highlights the dropdown area.
- User (Email):** A text input field containing the text 'Dr. Demo, InvisalignGo'.
- Password:** A text input field.
- Login:** A button.
- Demo Login:** A button.

Figure 26: Login window with a list of demo users

3. Select **Dr. Demo, InvisalignGo** from the drop-down list.

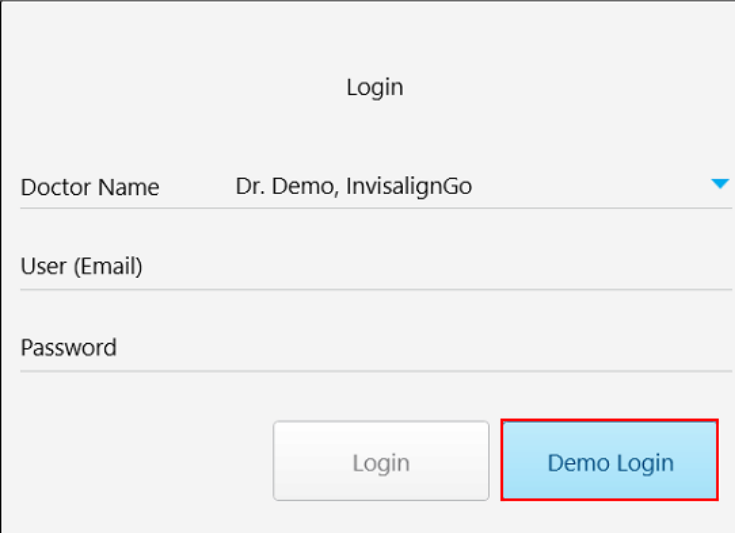

The screenshot shows the 'Login' window after the user has selected 'Dr. Demo, InvisalignGo' from the dropdown menu. The fields and buttons are:

- Doctor Name:** A dropdown menu showing 'Dr. Demo, InvisalignGo' with a blue arrow on the right.
- User (Email):** A text input field.
- Password:** A text input field.
- Login:** A button.
- Demo Login:** A button highlighted with a red box.

Figure 27: Demo Login button

4. Tap **Demo Login**.

The Demo Mode home screen is displayed, with **Demo Mode** shown on the top left of the window.

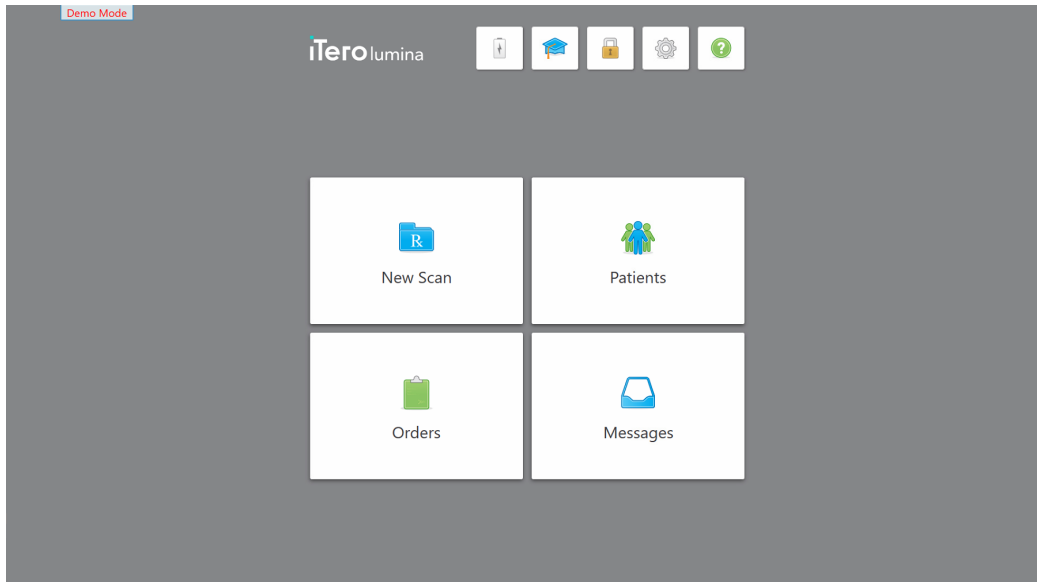

Figure 28: Demo Mode home screen

5. To view the demo cases, tap **Orders**.

A list of demo cases is displayed in the **Past Orders** pane, according to your iTero subscription package.

6. Tap the required demo case.

The selected case is expanded to show the following options:

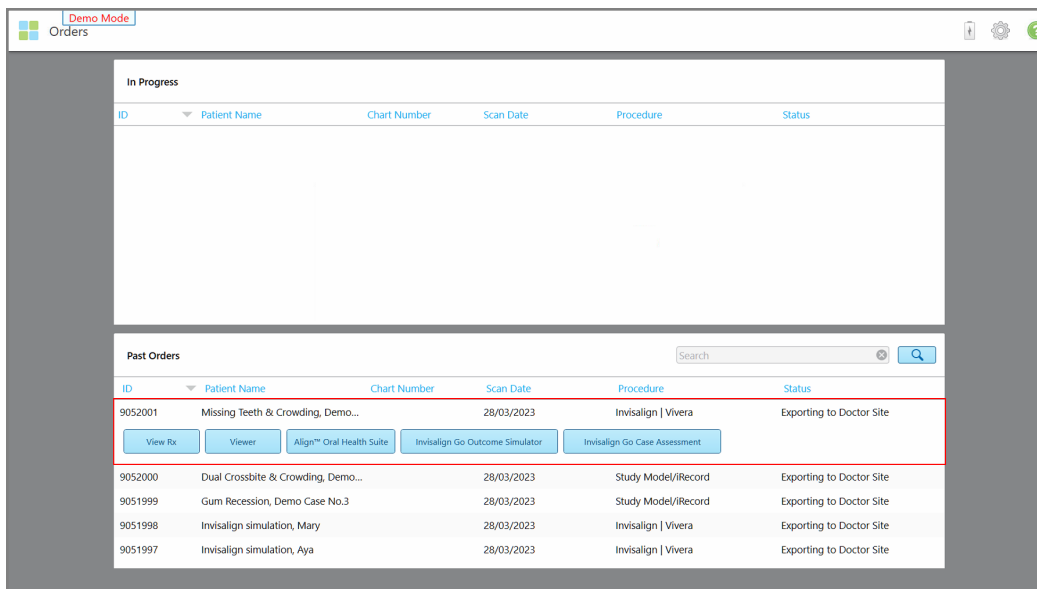

Figure 29: Past Orders pane – options

For more information on working with orders, see [Working with orders](#).

### 3.3.1 Align Oral Health Suite

Align Oral Health Suite is a comprehensive digital suite integrating multiple proprietary iTero visualization and diagnostic-aid tools into one easily accessible, patient-centric interface.

You can access Align Oral Health Suite when sending the scan by tapping **Send & View**, or after sending the scan from the patient's profile page or the **Orders** page. In addition, you can access Align Oral Health Suite from MyiTero.



**Figure 30: Align Oral Health Suite home screen**

Align Oral Health Suite enables you to view the scan in the context of select dental conditions and comprehensively explore potential areas of interest.

When you select a condition, the default view and tools for that condition are automatically selected so that you may start viewing the scan.

Tap the **How to get started** button for more information regarding using Align Oral Health Suite.

### 3.3.2 Exiting Demo Mode

To exit Demo mode:

1. Tap  to move to the home screen and then tap the iTerro Lumina logo at the top of the screen.

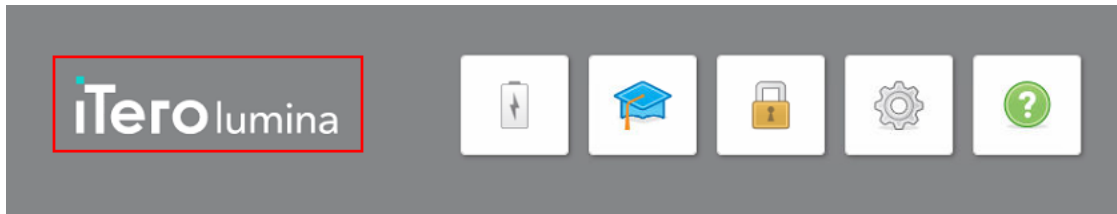

Figure 31: iTerro Lumina logo

2. Tap **Exit Demo** to exit Demo mode.



Figure 32: Exiting Demo mode

## 4 Working with the scanner

### 4.1 Logging in to the scanner

When the scanner is powered on, the *Login* window is displayed.

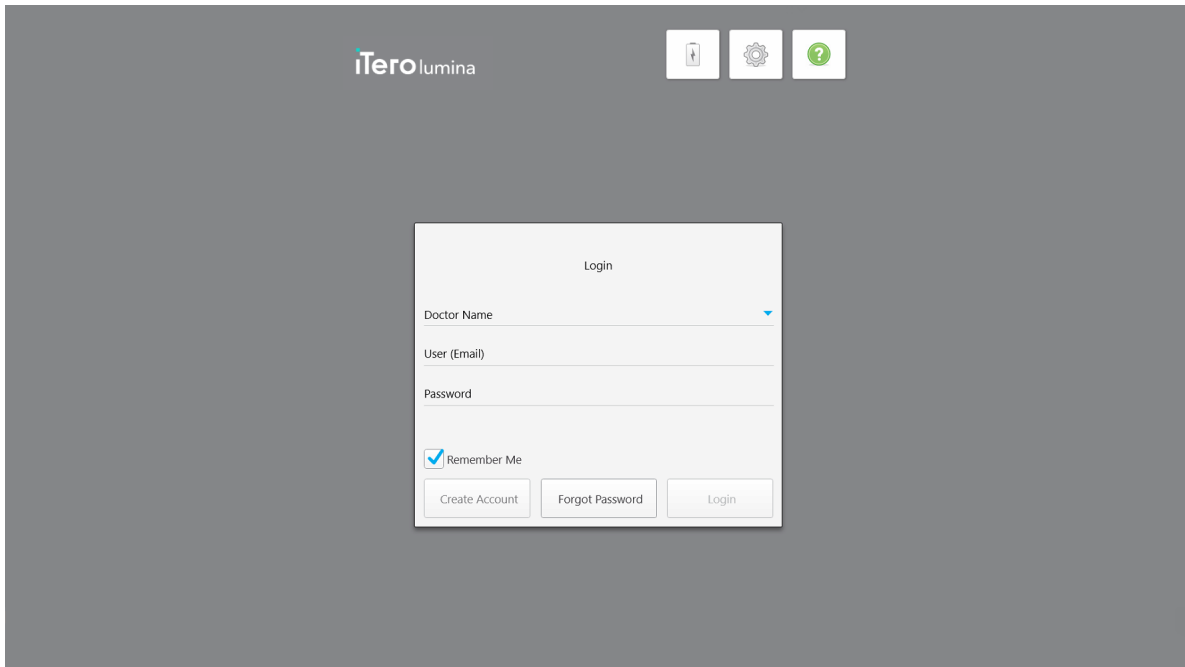

Figure 33: Login window

Make sure you have your MyAligntech account information ready when logging in to the iTero scanner. You need your name, account email, and password. Fill in all the necessary fields and then tap the **Login** button.

#### Notes:

- In order to ensure that you are using the latest version of the iTero software and that all Windows security patches are up to date, a notification is displayed as soon as the software updates are available for installation. For more information on scheduling the installation of these software updates, see [Updating the scanner software](#).

- If you did not shut down the scanner correctly previously, a message will be displayed notifying you of this and will remain until you acknowledge the message by tapping **I UNDERSTAND**. For more information on shutting down the scanner, see [Shutting down the scanner](#).

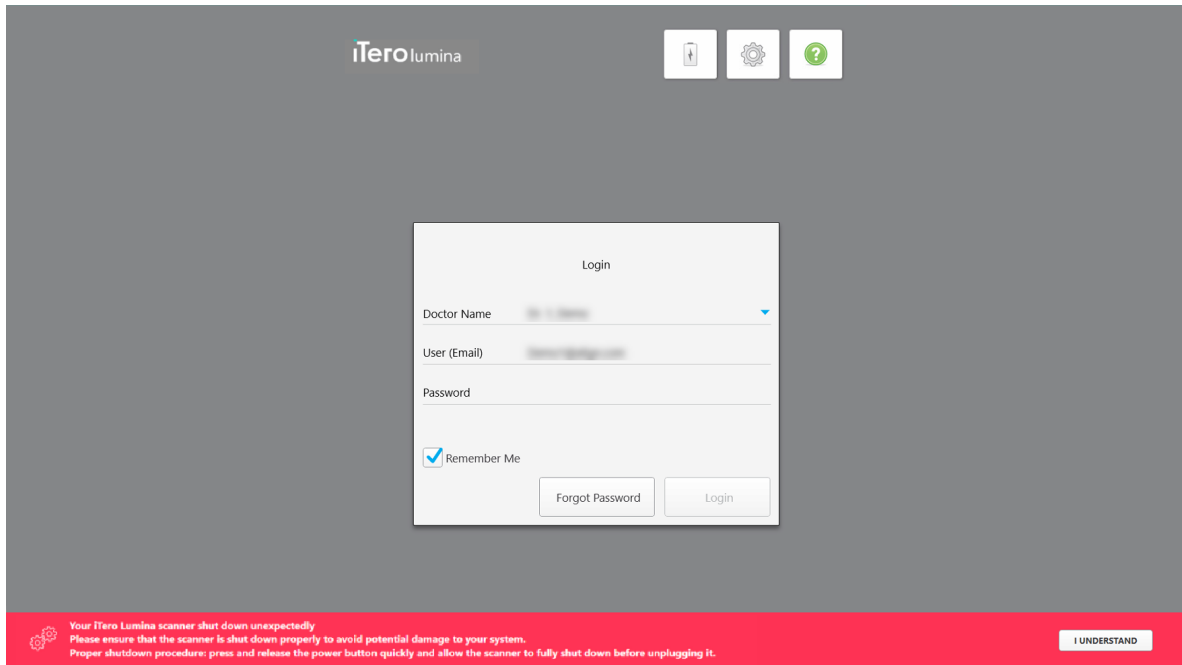
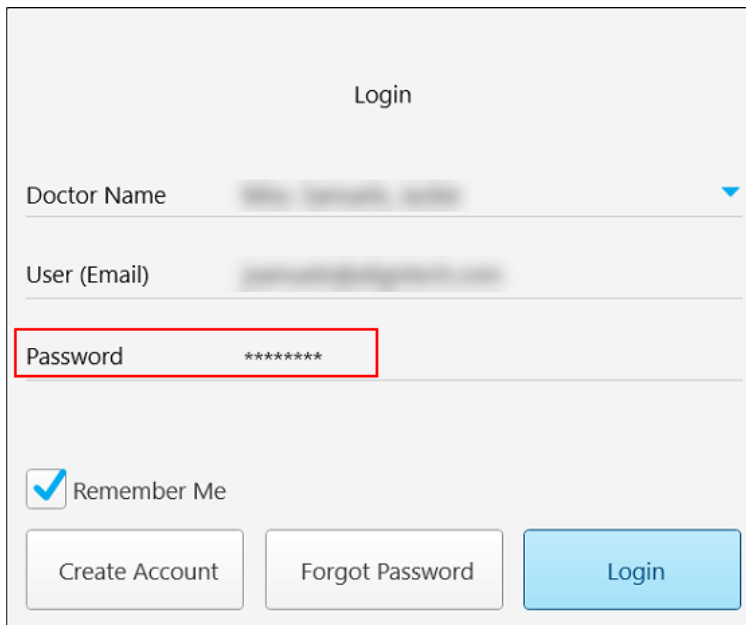

Figure 34: Unexpected shutdown notification

### To log in to the scanner:

1. Select your username from the **Doctor Name** drop-down list.
2. Enter the email address you used when registering with myaligntech.com. Your email address is displayed automatically if you selected the **Remember Me** check box in a previous login session.
3. Enter your password.

The text is masked as asterisks.



The screenshot shows a login interface with the following elements:

- Header: Login
- Form fields:
  - Doctor Name: [Redacted]
  - User (Email): [Redacted]
  - Password: [Redacted] (highlighted with a red box)
- Remember Me:  Remember Me
- Buttons: Create Account, Forgot Password, Login

Figure 35: Password is masked

If you have forgotten your password, you can reset it, as described in [Resetting your password](#).

4. Select the **Remember Me** check box for the system to remember your email address in future sessions. You will still need to enter your password in order to access the scanner.
5. Tap **Login**.

The iTero home screen is displayed.

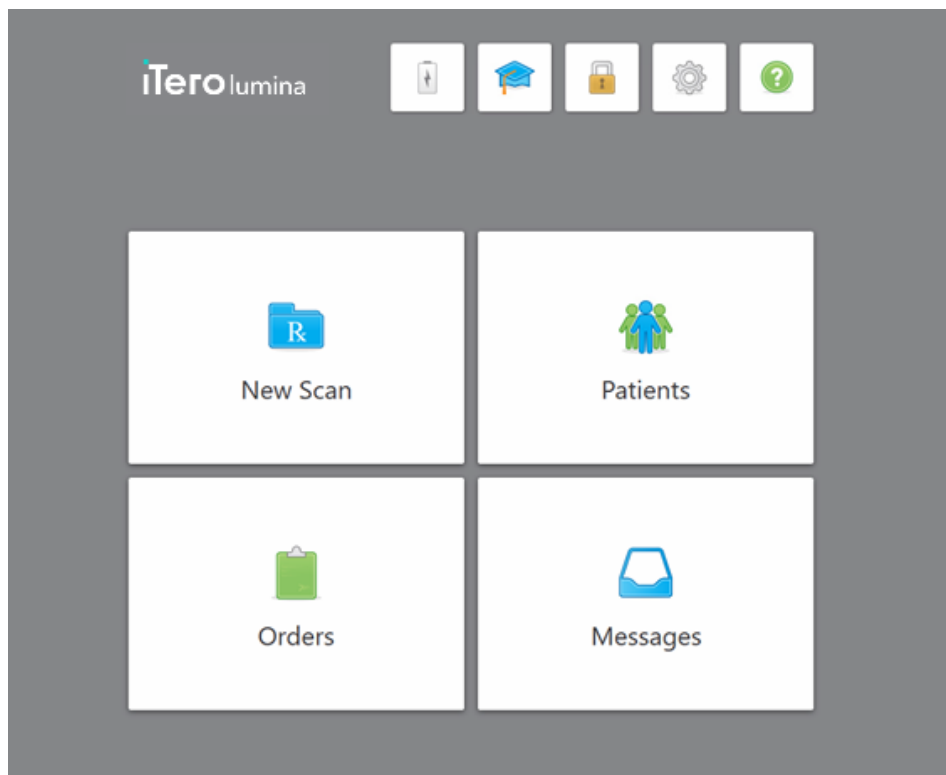

Figure 36: iTero home screen

### 4.1.1 Resetting your password

You can reset your password, if required.

**To reset your password:**

1. In the *Login* window, tap **Forgot Password**.

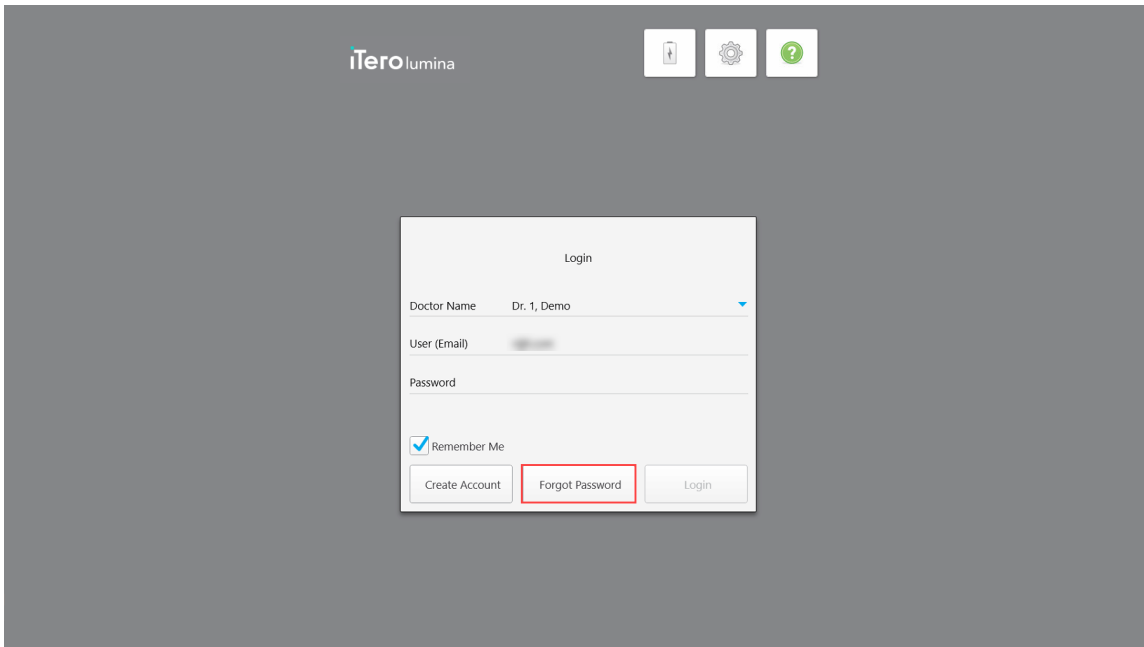

**Figure 37: Forgot Password button**

A window is displayed, describing what you should do next.

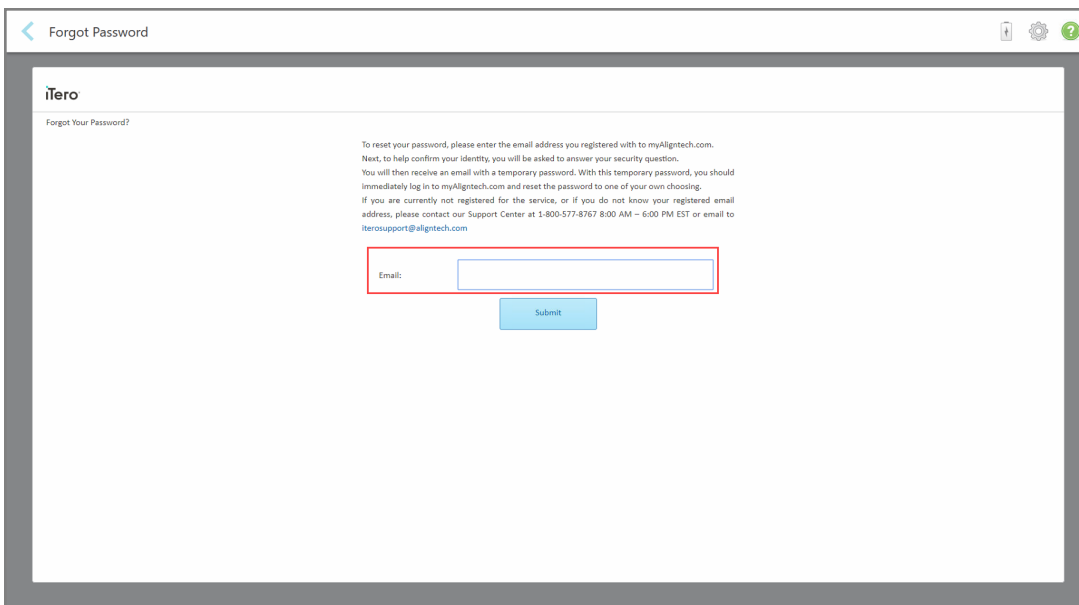

**Figure 38: Email field for forgotten password**

2. In the **Email** field, enter the email address you used to register for myaligntech.com.
3. Tap **Submit**.

Your predetermined security question is displayed.

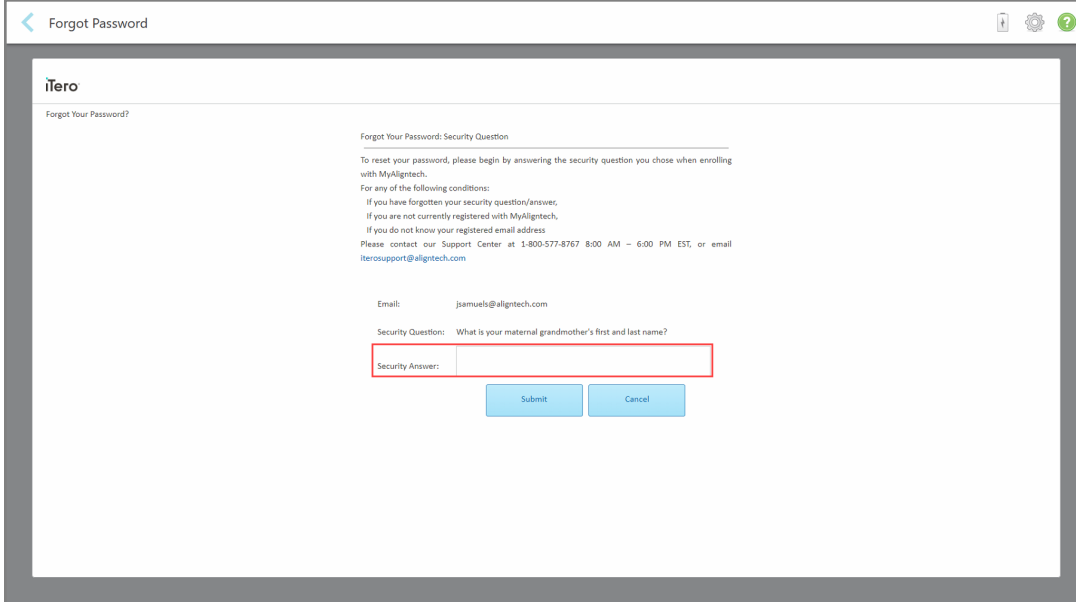

The screenshot shows a mobile application interface for a password reset. At the top, there is a navigation bar with a back arrow and the text 'Forgot Password'. Below this, the iTero logo is visible. The main content area is titled 'Forgot Your Password?' and contains the following text: 'Forgot Your Password: Security Question', 'To reset your password, please begin by answering the security question you chose when enrolling with MyAlignTech.', and 'For any of the following conditions: If you have forgotten your security question/answer, If you are not currently registered with MyAlignTech, If you do not know your registered email address'. Below this text, the email address 'jsamuels@aligntech.com' is displayed. The security question is 'What is your maternal grandmother's first and last name?'. Below the question is a text input field for the 'Security Answer', which is highlighted with a red border. At the bottom of the form, there are two buttons: 'Submit' and 'Cancel'.

**Figure 39: Security answer field**

4. Enter the answer to the security question.  
A temporary password will be sent to you.
5. Use the temporary password to log in to myaligntech.com and then reset your password, according to the iTero password policy described in [iTero password policy](#).
6. If you do not know your registered email address, contact iTero Customer Support.

#### 4.1.1.1 iTero password policy

When changing your password, ensure that your new password meets the following criteria:

- At least eight characters in length
- No spaces
- At least one upper-case letter
- At least one lower-case letter
- At least one number
- Optional: Passwords may include special characters (for example: !, #, \$, %, ^)

### 4.1.2 Updating the scanner software

In order to ensure that the scanner software is up to date and to support the continuous cyber security of the scanner, whenever a new software version is available, it is downloaded to the scanner and must be installed *within 7 days*. Software updates include new features as applicable, software improvements, and security-related items.

After the software updates have been downloaded, a *Software Updates/Security Updates* window is displayed when logging in to the scanner, notifying you about these updates and enabling you to schedule a time they should be installed – postponed daily for up to 7 days, immediately, or later the same night.

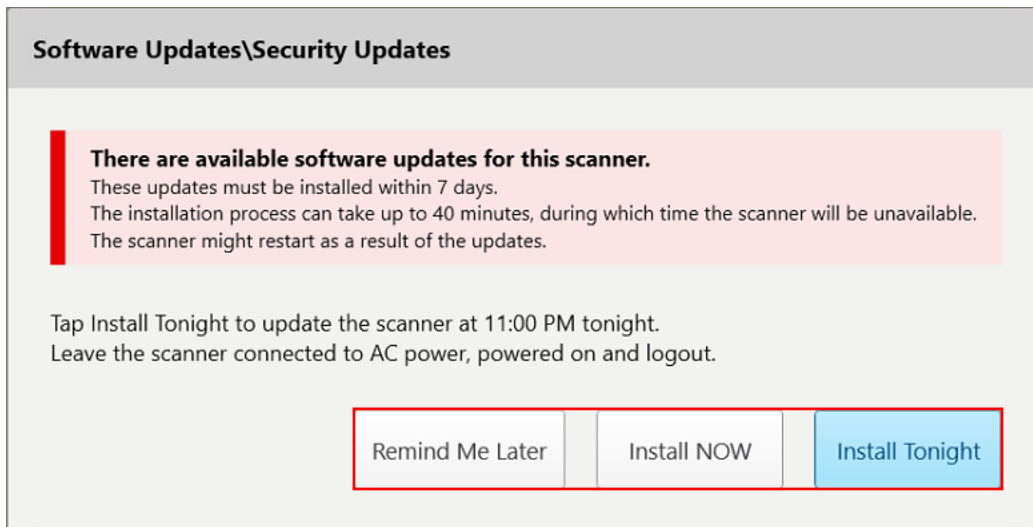

Figure 40: Software Updates/Security Updates window – scheduling options

To install the software updates, the scanner needs to be connected to the AC power and switched on, and you need to log out.

#### Notes:

- Installing the updates should take about 40 minutes during which time the scanner cannot be used.
- Once the installation starts, it cannot be paused or canceled.
- If you ignore the message and do not install the software updates within 7 days, they will be installed automatically the next time the scanner is restarted.

#### To schedule the software-update installation:

1. In the *Software Updates/Security Updates* window, tap one of the following scheduling options:
  - **Remind Me Later:** The software installation is postponed for up to 7 days. For more information, see [Remind Me Later – Postponing the software update installation](#).
  - **Install NOW:** The software is installed immediately.
  - **Install Tonight:** The software will be installed at 11 PM that night. For more information, see [Install Tonight – Installing the software updates later that night](#).

2. Before the installation is due to take place, make sure that the scanner is connected to the AC power and switched on, and that you have logged out.

If the scanner is not connected to the AC power, you are prompted to connect it.



Figure 41: Connect the scanner to the AC power

- Plug in the scanner and then tap **Continue**.

The installation starts and a message is displayed showing the installation progress.

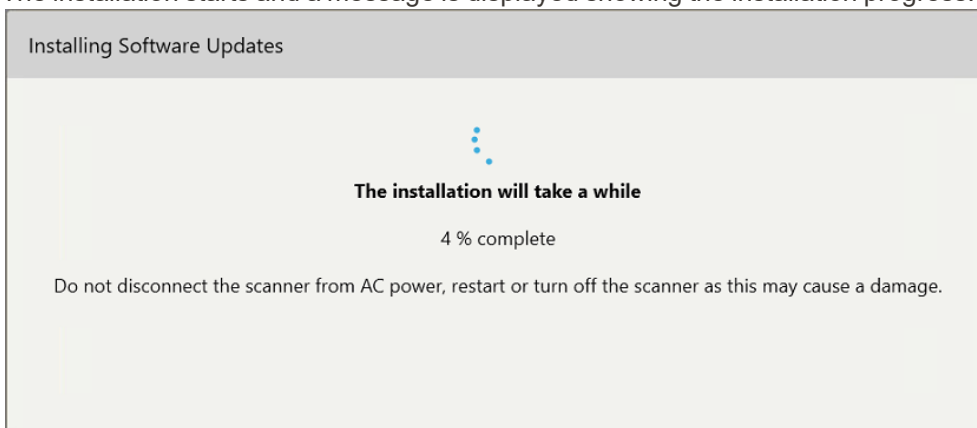

Figure 42: Installation in progress

**Note:** Do not unplug, restart, or turn off the scanner while the software updates are being installed.

Once the software has been installed, a success notification is displayed and the scanner restarts.

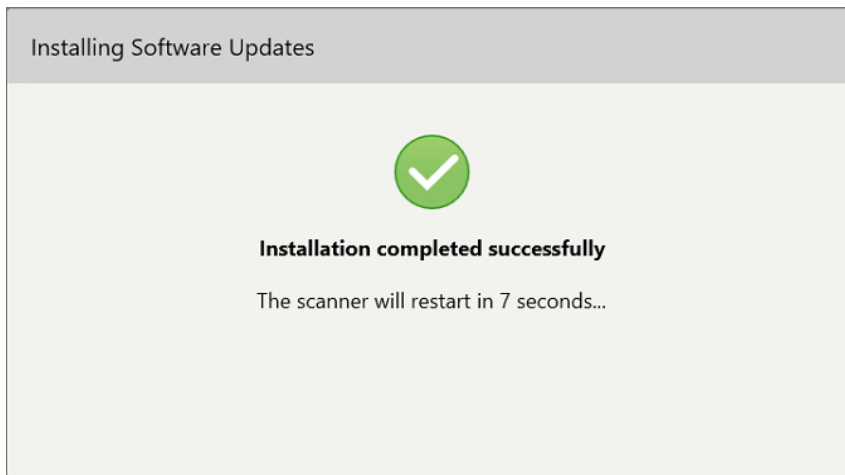

Figure 43: Installation completed successfully

#### 4.1.2.1 Remind Me Later – Postponing the software update installation

You can postpone the software-update installation for up to a week. Every day, the notification will display the number of days remaining until the updates have to be installed. You can select to postpone the updates, install them immediately, or schedule them for later that night.

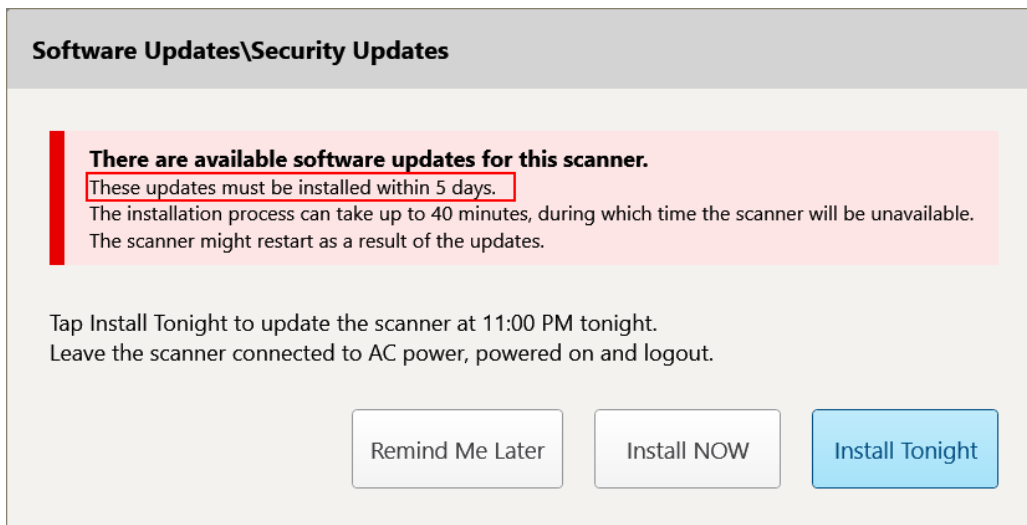

Figure 44: Software updates – number of days until the updates must be installed

On the 7th day, the software updates must be installed. You can select whether to install them immediately, or schedule the installation for later that night, as described below.

**Note:** If you ignore the message and do not install the updates, they will be installed automatically the next time the scanner is restarted.

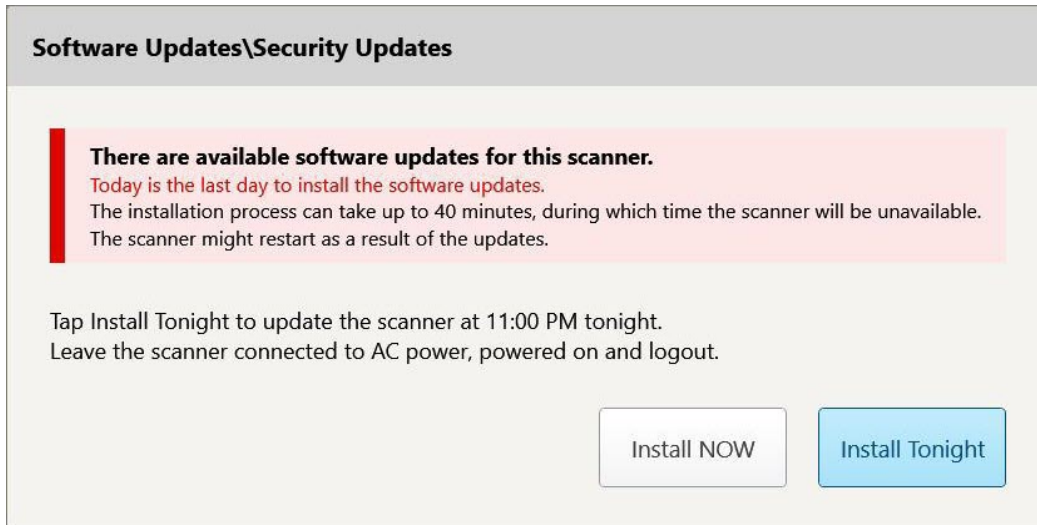
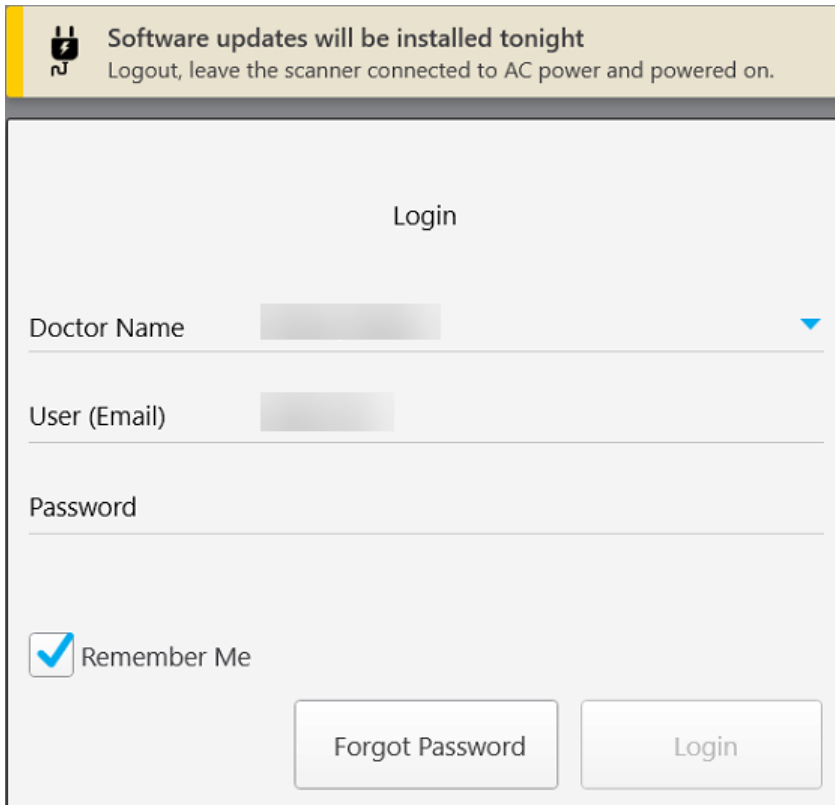

Figure 45: Software updates – last day

#### 4.1.2.2 Install Tonight – Installing the software updates later that night

If you select to install the software updates later that night, a banner is displayed above the scanner *Login* window and the home screen reminding you that you need to log out and the scanner needs to be connected to the AC power and switched on.



The screenshot shows a login window with a notification banner at the top. The banner has a yellow background and contains a power icon, the text "Software updates will be installed tonight", and the instruction "Logout, leave the scanner connected to AC power and powered on." Below the banner, the login form is titled "Login" and includes three input fields: "Doctor Name" (with a dropdown arrow), "User (Email)", and "Password". At the bottom left, there is a checked checkbox labeled "Remember Me". At the bottom right, there are two buttons: "Forgot Password" and "Login".

Figure 46: Software updates notification – Login window



Figure 47: Software updates notification – home screen

## 4.2 Logging out of the scanner

In order to protect the patient information, you should log out of the scanner when it is not in use. Your password will *not* be remembered by the system.

By default, you will be logged out after a predefined period of inactivity, which can be defined in the **Login** settings, described in [Defining the login settings](#).

### To log out of the scanner:

1. Tap  to return to the home screen.

2. Tap  to log out of the system.

The *Login* window is displayed, ready for the next user to log in to the system.

### 4.3 Shutting down the scanner

It is recommended to shut down the scanner at the end of each day, to ensure optimal performance.

**Note:** Do not shut down the scanner if you have scheduled a software installation for that night, as described in [Install Tonight – Installing the software updates later that night](#).

#### To shut down the scanner:

- Press and release the Power button to shut down the system. The Power button is located on the top right of the screen.

**Note:** If you do not shut down the scanner correctly, the next time you log on, a message will be displayed notifying you of this and will remain until you acknowledge it.

Incorrect shutdown can be caused by letting the battery run down and by pressing the Power button for longer than 4 seconds, which activates a hard reset and can cause problems such as gray and blue screens.

### 4.4 Moving the scanner

#### 4.4.1 Moving the iTerio Lumina cart-configuration scanner

The scanner can be moved between rooms within the office and while you are seated, with a patient.

#### To move the scanner between rooms:

1. Ensure that the wand is firmly positioned in the cradle, with the optical window facing the cradle.
2. Unplug the system from the wall outlet and carefully wrap the power cable around the upper handle, to prevent the cable from being caught between the wheels.
3. Using the upper handle, move the system to its new location and plug it into a wall outlet.

**Note:** If the scanner needs to be lifted, lift it using the upper handle and the post.

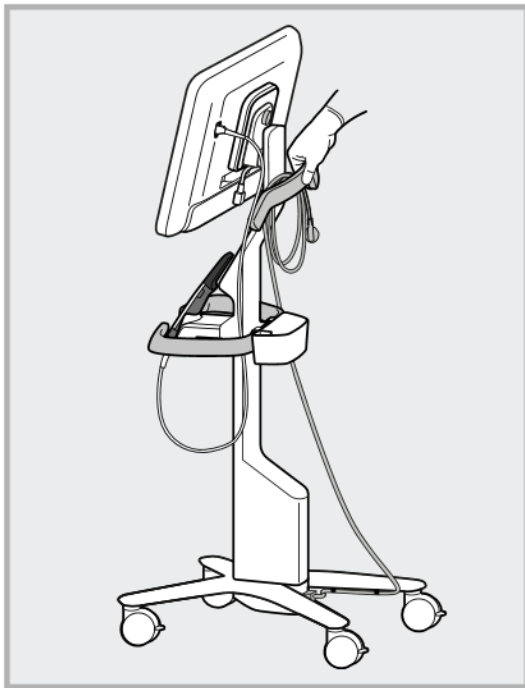

Figure 48: Moving the scanner

**To move the cart-configuration scanner while in a seated position:**

- Use the main handle to move the scanner.
- The screen height is optimized for a more ergonomic experience while seated. If required, you can adjust the tilt of the screen.

**Note:** Do not use the wand or the wand cable to move the scanner, in order to reduce the risk of the scanner toppling over or damage to the cable.

#### 4.4.2 Carrying the iTero Lumina mobile-configuration scanner within the clinic

The mobile-configuration scanner can be carried between rooms within the clinic as well as transported between clinics.

When carrying the scanner, you should always move the handle to the carrying position and wind the wand cable around the cradle.

**To carry the mobile-configuration scanner within the clinic:**

1. Ensure that the wand is firmly positioned in the cradle, with the optical window facing the cradle.
2. Disconnect the power cable from the mains and then from the back of the computing unit.
3. While holding the computing unit with one hand, slide the locking latch to unlock the handle and then move the handle to the carrying position. For more information, see [Moving the scanner within the clinic](#).

4. Loosely wrap the cable around the cradle for easy and safe portability.

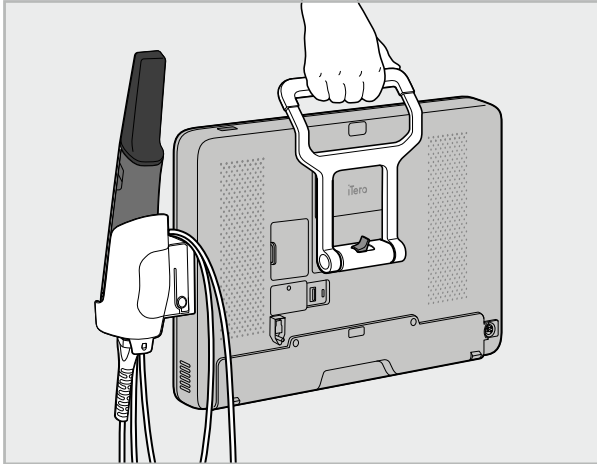

Figure 49: Carrying the scanner between rooms within the clinic

#### 4.4.3 Transporting the iTero Lumina mobile-configuration scanner between clinics

When transporting the mobile-configuration scanner between clinics, always pack the scanner in its supplied trolley. For more information, see [Using the trolley for transportation](#).

##### To transport the scanner between clinics:

1. Turn off the scanner, as described in [Shutting down the scanner](#).
2. Disconnect the power cable from the mains and then from the back of the computing unit.
3. Disconnect the scanner components and pack them in their designated compartments in the trolley. For more information, see [Using the trolley for transportation](#).
4. Close and secure the trolley flap and then close the trolley by lifting the side with the fastened flap and zipping it closed.



Figure 50: Transporting the scanner between clinics

- If required, use the optional protective cover to protect the trolley against wear and tear and adverse weather conditions. For more information, see [Optional protective trolley cover](#).

## 4.5 User interface

The iTero system provides an intuitive user interface for performing digital scans for Restorative or Orthodontic use. The touch screen is used to interact with and control the software, while the wand buttons are used to start and stop the scan.

For a list of the touch-screen gestures that can be used, see [Touch-screen gestures](#).

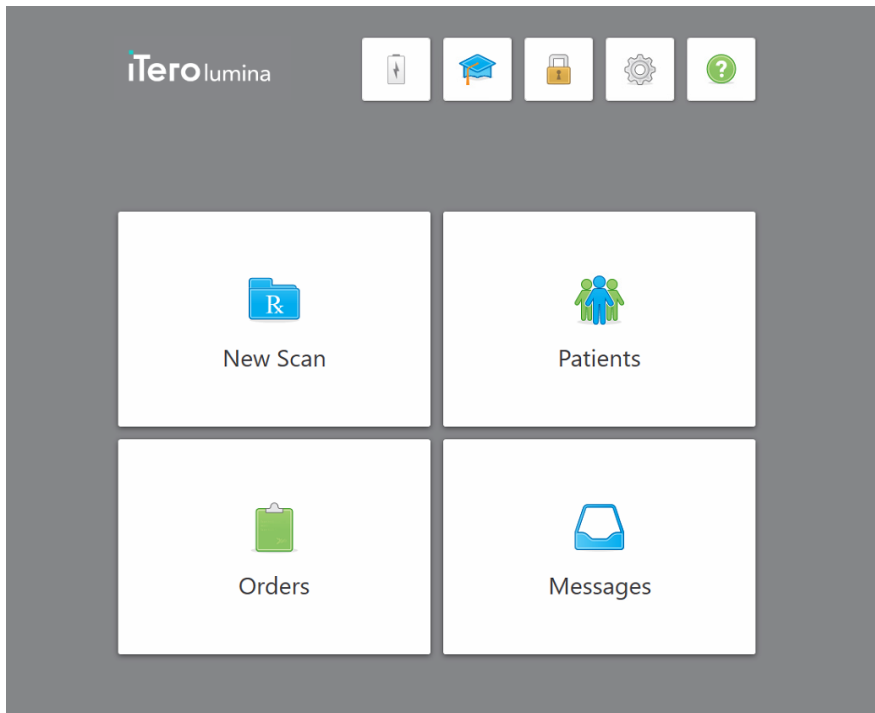

**Figure 51: iTero home screen**

The following buttons are displayed on the home screen:



Displays the status of the battery:

- A lightning bolt indicates that the scanner is connected to the power, and the battery is charging.
- When using battery power, the remaining charge level is displayed on the battery icon. When the remaining charge level falls below 25%, the battery

icon is displayed in red



- Tap the battery icon to view the percentage of remaining charge:

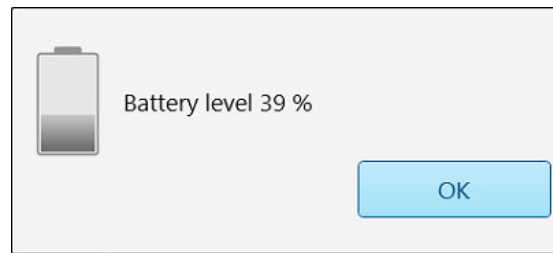

Figure 52: Percentage of remaining battery charge



**Learning Center:** Tap to access training materials and educational videos for the iTero scanner.



**Lock:** Tap to log out of your account whenever the scanner is not in use, as described in [Logging out of the scanner](#). This helps ensure that the dental practice is HIPAA compliant, and that all medical information is secure.

**Tip:** You should lock the system while cleaning it, in order to avoid unintended entries.



**Settings:** Tap to adjust the scanner preferences, for example, for wand configuration, localization, user settings, and more. For more information, see [Defining the scanner settings](#).



**Help:** Tap to display a translucent Help overlay with hints to aid in the navigation of features and tools.

In this view, the **Help** button changes to two new buttons – e-manual and Customer Support:

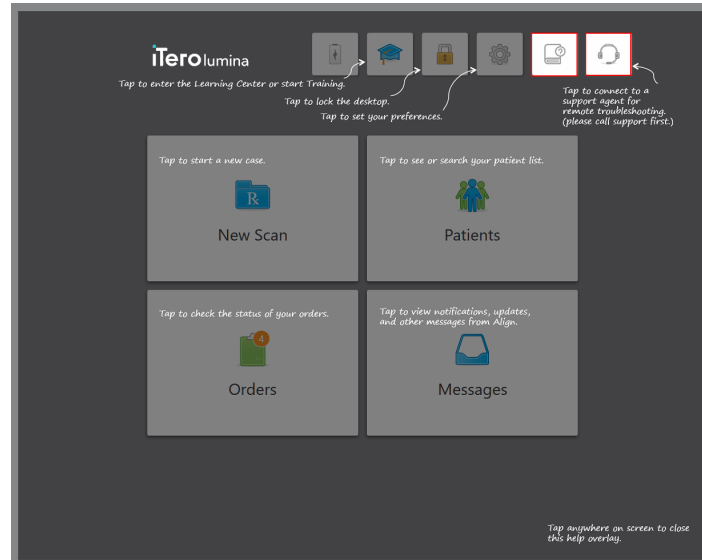

**Figure 53: Help overlay including the e-manual and Customer Support buttons**



Tap to access the relevant iTero Lumina e-manual.



Tap for remote assistance from Customer Support. Customer Support is available from every Help overlay.

**Note:** Please call Customer Support before trying to connect remotely.

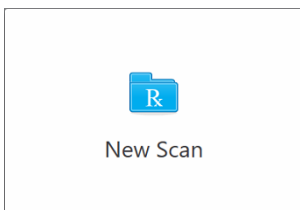

**New Scan:** Tap to open the *New Scan* window to fill in the Rx before starting a new scan. For more information, see [Starting a new scan](#).



**Patients:** Tap to view the *Patients* page with a list of all patients registered in your iTero system, and if relevant, their chart number, date of birth, and the date of their last scan. For more information, see [Working with patients](#).

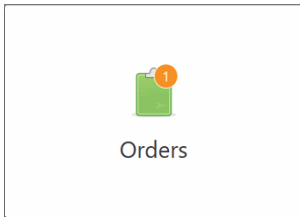

**Orders:** Tap to display a list of all your orders. For more information, see [Working with orders](#).

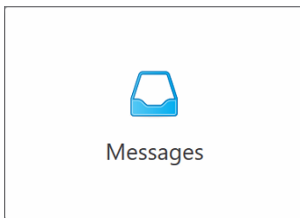

**Messages:** Tap to view the messages from Align Technology. For more information, see [Viewing messages](#).

The **Battery** and **Settings** buttons are displayed on each of the scanner windows as well, as described in [Scanner toolbar](#).

### 4.5.1 Scanner toolbar

The following toolbar is displayed on the top of each of the scanner windows:



Figure 54: Scanner toolbar

The 4 center buttons indicate the status of the scan process. Tap the buttons to navigate through the scan flow.



Tap to return to the home screen.

New Scan

Displays the current stage in the scanning process, also indicated by the relevant highlighted button in the toolbar.



Tap to return to the *New Scan* window to view the Rx, as described in [Filling in the Rx](#).



Tap to move to Scan mode to scan the patient, as described in [Scanning the patient](#).



Tap to move to View mode to view the scanned model, as described in [Viewing the scan](#).



Tap to send the scanned model to the lab, your chairside milling software, or your MyiTero account, as described in [Sending the scan](#).



Indicates that the wand is still in the initialization and warm-up phase and not ready for use.



Displays the status of the battery:

- A lightning bolt indicates that the scanner is connected to the power, and the battery is charging.
- When using battery power, the remaining charge level is displayed on the battery icon. When the remaining charge level falls below 25%, the battery icon is displayed

in red .

- Tap the battery icon to view the percentage of the remaining charge:

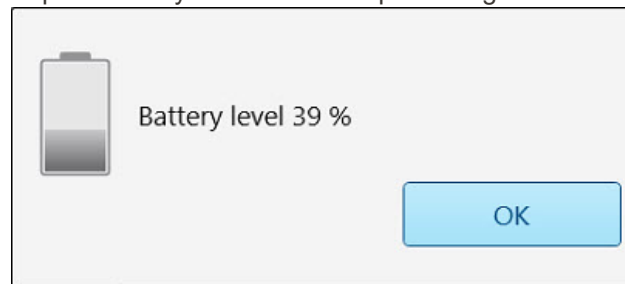

Figure 55: Percentage of remaining battery charge



Tap to adjust the scanner preferences, for example, for wand configuration, localization, user settings, and more.

For more information on the Settings preferences, see [Defining the scanner settings](#).



Tap to display a translucent Help overlay with hints to aid in the navigation of features and tools.

In this view, the **Help** button changes to two new buttons – e-manual and Customer Support:

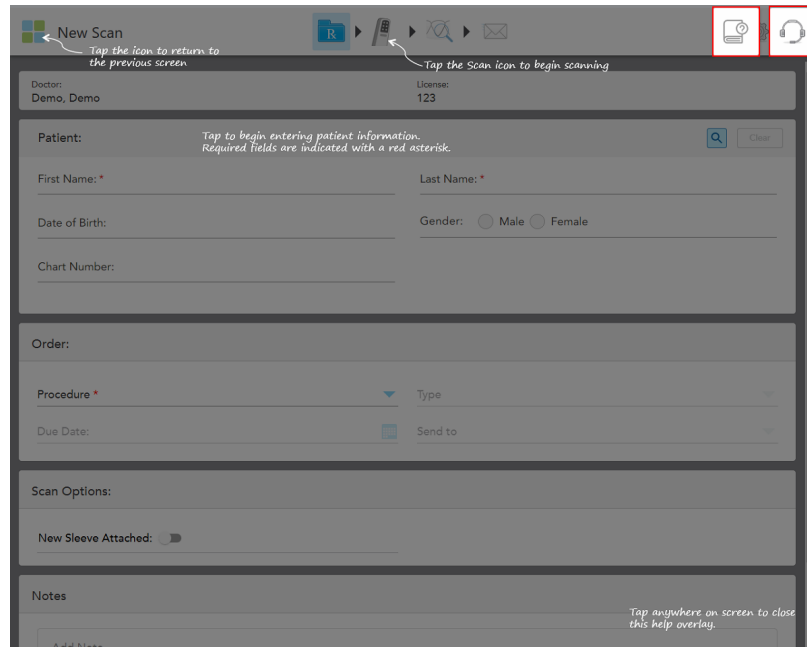

**Figure 56:** Help overlay including e-manual and Customer Support buttons



Tap to access the relevant iTerio Lumina e-manual.



Tap for remote assistance from Customer Support. Customer Support is available from every Help overlay.

**Note:** Please call Customer Support before trying to connect remotely.

## 4.5.2 Touch-screen gestures

The iTero software supports touch-screen (also known as multi-touch) gestures. These gestures are predefined motions used to interact with multi-touch devices.

Examples of common touch-screen gestures:



Tap



Double tap



Long press



Scroll



Rotate



Swipe



Pan



Zoom out



Zoom in

## 4.6 Defining the scanner settings

The scanner settings enable you to define your preferences and the settings that are displayed by default when you use the scanner.

**To define the scanner settings:**

1. Tap the  button.

The *Settings* window is displayed.

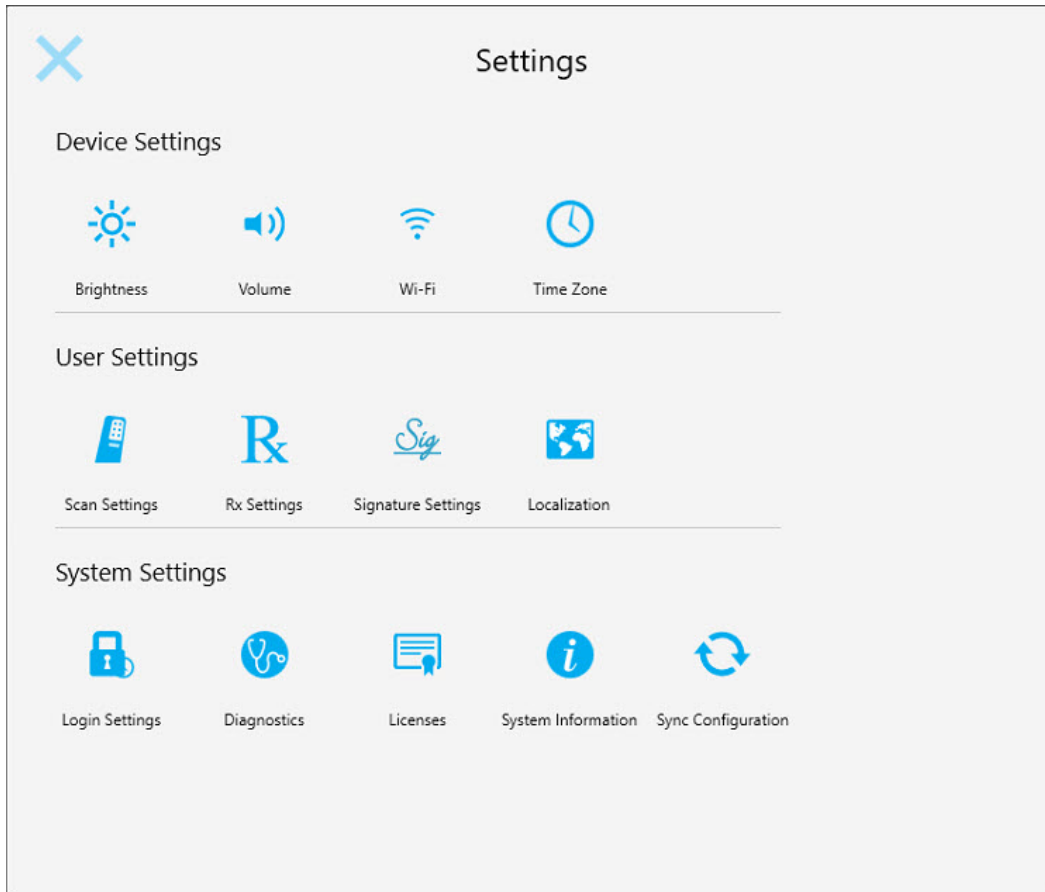



Figure 57: Settings window

2. Tap the settings you would like to define.
  - [Device settings](#)
  - [User settings](#)
  - [System settings](#)

The relevant window opens.

3. Make your required changes and then tap  to save the changes and return to the *Settings* window.

#### 4.6.1 Defining the Device settings

The Device settings enable you to define the brightness, volume, Wi-Fi, and time-zone settings for the scanner.

##### 4.6.1.1 Defining the default brightness setting

To define the default brightness setting, tap the **Brightness** button, move the slider to the required brightness level, and then tap  to save the changes and return to the *Settings* window.



Figure 58: Brightness settings

##### 4.6.1.2 Defining the default volume setting

To define the default system volume, tap the **Volume** button, move the slider to the required volume level, and then tap  to save the changes and return to the *Settings* window.



Figure 59: Volume settings

In addition to the system sounds, the volume settings define the volume for the content from the Learning

Center .

### 4.6.1.3 Defining the Wi-Fi settings

The first time you connect the scanner to the clinic's Wi-Fi network, you will need to add the password. After that, by default, the scanner will connect automatically. If you want to connect to a different Wi-Fi network, select the new network and enter the relevant password.

#### To reconnect to a Wi-Fi network:

1. Tap the **Wi-Fi** button.

A list of nearby Wi-Fi networks is displayed.

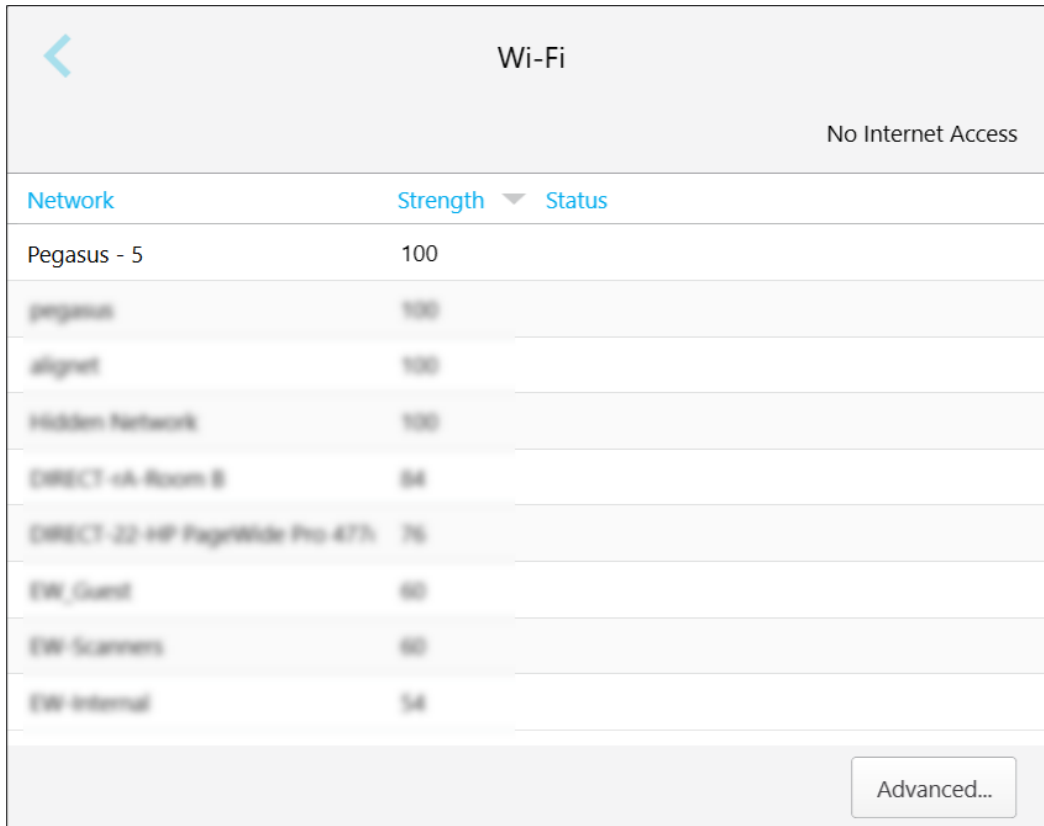

Figure 60: List of nearby Wi-Fi networks

2. Select the clinic network, for example, Pegasus - 5, and then tap **Connect**.

3. Enter the network security key (password) in the window that opens and then tap **Connect**.

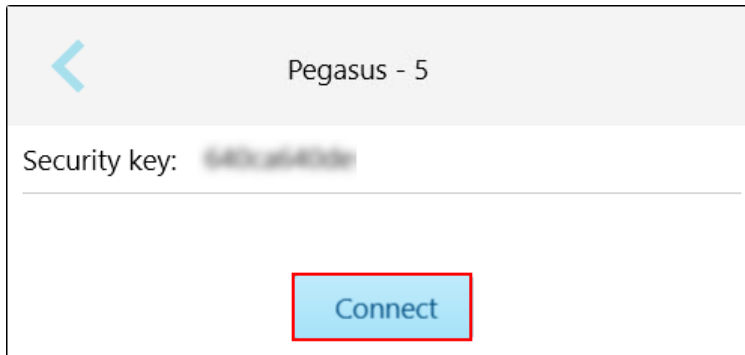

Figure 61: Connecting to the clinic Wi-Fi network

The scanner connects to the Wi-Fi network, and the status changes to **Connected**.

4. If you do not want to connect to the network automatically, tap the network you are connected to and then tap **Forget**.

You will need to select the required network and enter the Wi-Fi password the next time you want to connect.

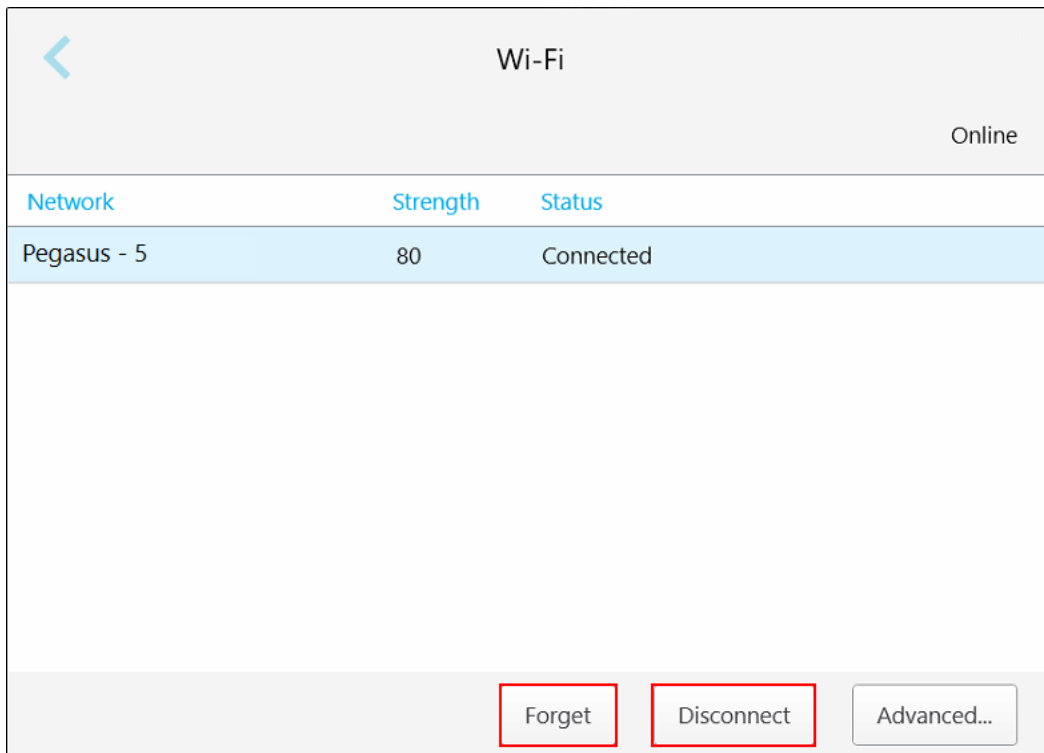



Figure 62: Forgetting or Disconnecting from the network

5. To disconnect from the network, tap **Disconnect**.
6. Tap  to save the settings and return to the *Settings* window.

#### 4.6.1.4 Defining the time zone

To define the time zone, tap the **Time Zone** button, select the time zone from the drop-down list, and then tap  to save the changes and return to the *Settings* window.

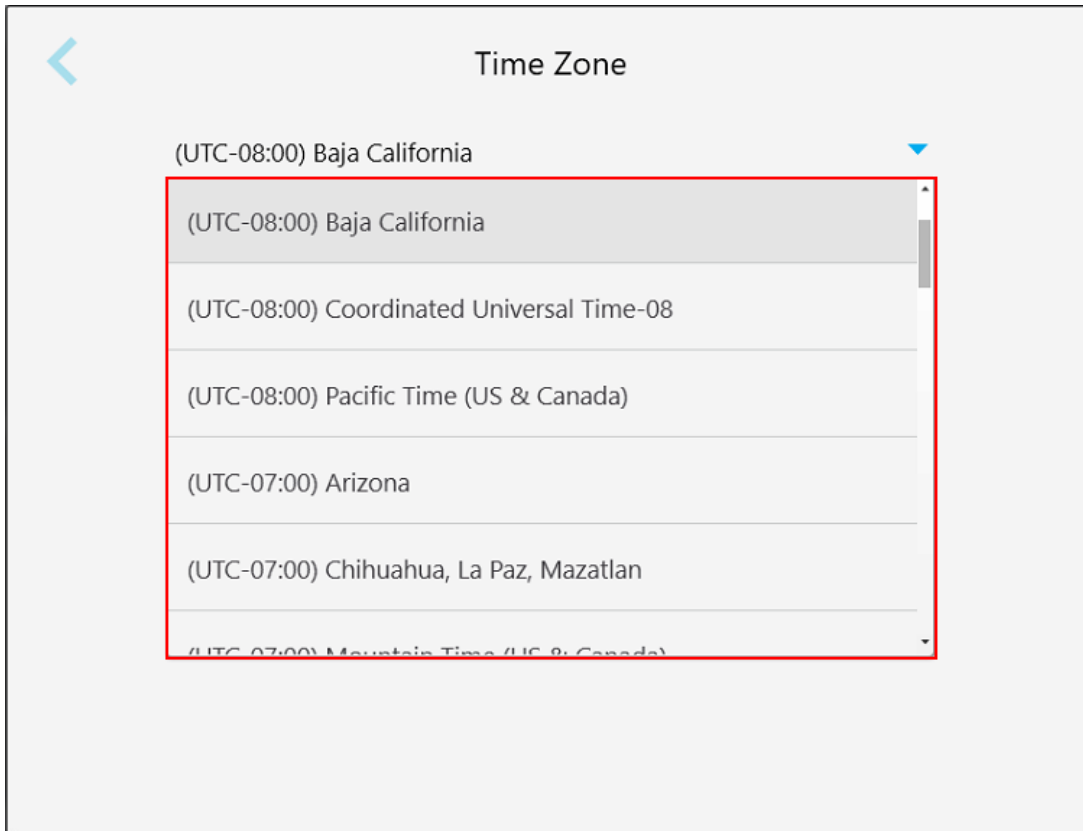

Figure 63: Time zone settings

**Note:** The time zone settings can be accessed only when you are logged in to the scanner.

## 4.6.2 Defining the User settings

The User settings enable each user to define the settings that are displayed by default when the specific user logs in to the scanner.

### 4.6.2.1 Defining the scan settings

You can define the default settings that are taken into account when scanning a patient.

**To define the scan settings:**

1. Tap the **Scan Settings** button.

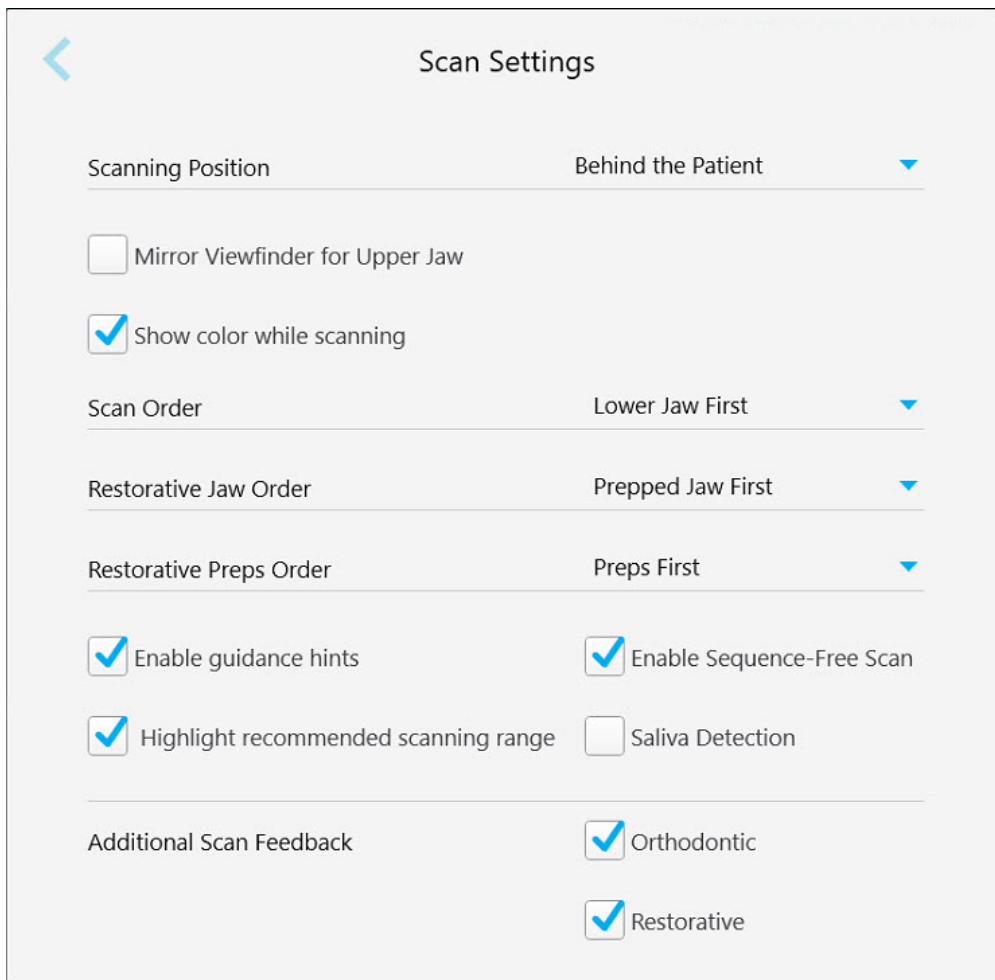

Figure 64: Scan Settings window

2. Select the default scanning preferences from the *Scan Settings* window.

Scan setting	Scan options
<b>Scanning Position</b>	Select your position while scanning the patient: <ul style="list-style-type: none"> <li>• Behind the patient</li> <li>• In front of the patient</li> </ul>
<b>Mirror Viewfinder for Upper Jaw</b> check box	Select this check box to define the orientation of the viewfinder when scanning the upper jaw.
<b>Show color while scanning</b> check box	Select this check box to show the 3D model in color while scanning, by default.
<b>Scan Order</b>	Select the order in which to scan the jaws: <ul style="list-style-type: none"> <li>• Upper Jaw First</li> <li>• Lower Jaw First</li> </ul>
<b>Restorative Jaw Order</b>	Select the order in which to scan the jaws for fixed restorative procedures: <ul style="list-style-type: none"> <li>• Opposite Jaw First</li> <li>• Prepped Jaw First</li> </ul>
<b>Restorative Preps Order</b>	Select the order in which to scan the prepped teeth and the arches in fixed restorative procedures: <ul style="list-style-type: none"> <li>• Preps First</li> <li>• Arch First</li> <li>• No Guidance</li> </ul>
<b>Enable guidance hints</b> check box	Select this check box to display guidance when scanning, as described in <a href="#">Scanning guidance</a> .
<b>Enable Sequence-Free Scan</b>	Select this check box to enable scanning without a set protocol. For more information, see <a href="#">Working with unstitched scanned segments</a> .  If this check box is not selected, you will need to follow the Align scanning protocol.
<b>Saliva Detection</b>	Select this check box to enable saliva detection when scanning. For more information, see <a href="#">Saliva detection</a> .

Scan setting	Scan options
	If you clear the check box, a confirmation message is displayed notifying that saliva moisture control is still required and that areas in which saliva is detected may need to be removed and rescanned.

**Highlight recommended scanning range**  
check box

Select this check box to highlight only the scanning range on the navigation controls. Relevant for restorative procedure types only.

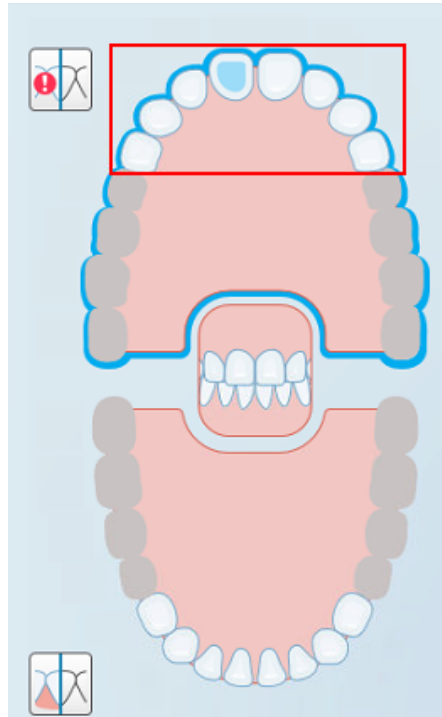



Figure 65: Only the scanning range is highlighted

<b>Additional Scan Feedback</b>	<p>Select the relevant check boxes to display areas of missing anatomy while scanning, as described in <a href="#">Additional scan feedback</a>.</p> <ul style="list-style-type: none"> <li>• Orthodontic</li> <li>• Restorative</li> </ul>
---------------------------------	---

3. Tap  to save the changes and return to the *Settings* window.

#### 4.6.2.2 Defining the Rx settings

You can define the settings that are displayed by default when you open the *Scan Details* window to fill in a new Rx.

**To define the Rx settings:**

1. Tap the **Rx Settings** button.

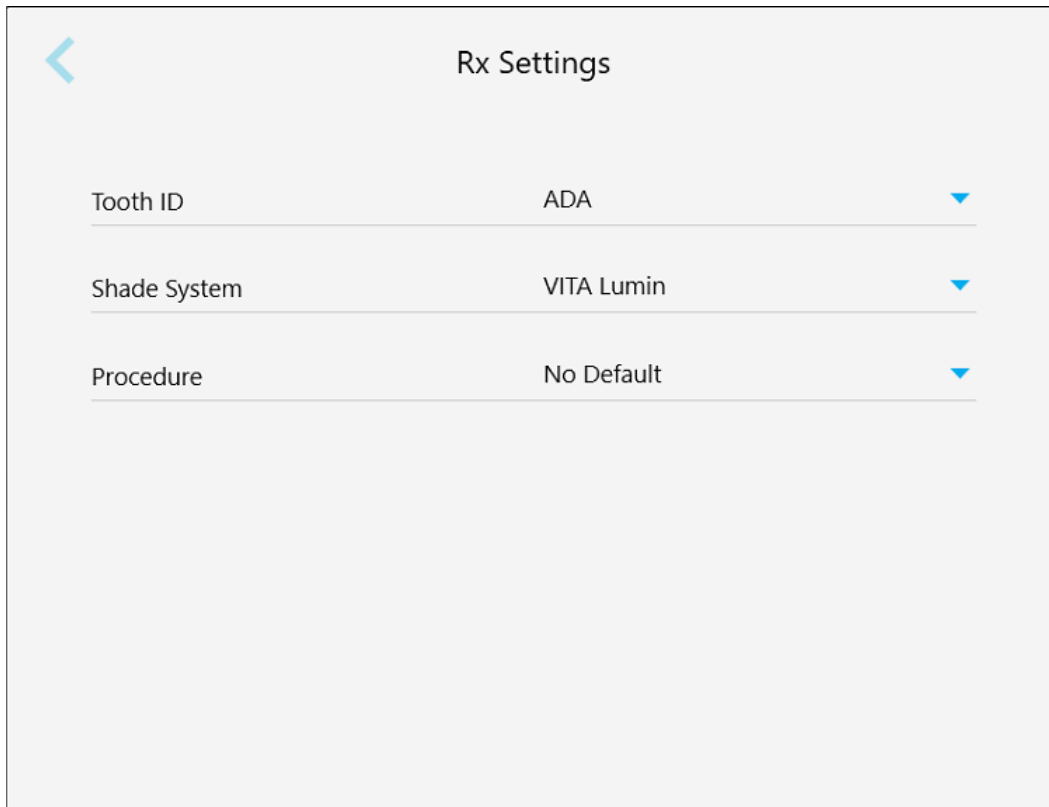



Figure 66: Rx Settings window

2. Select the default Rx preferences from the *Rx Settings* window.

Rx setting	Rx options
<b>Tooth ID</b>	Select the default tooth ID system: <ul style="list-style-type: none"> <li>• FDI</li> <li>• ADA</li> <li>• Quadrant</li> </ul>
<b>Shade System</b>	Select the default shade system: <ul style="list-style-type: none"> <li>• VITA Lumin</li> <li>• VITApan 3D Master</li> <li>• Other</li> </ul>
<b>Procedure</b>	Select the default procedure: <ul style="list-style-type: none"> <li>• Appliance</li> <li>• Denture/Removable</li> <li>• Fixed Restorative</li> <li>• Implant Planning</li> <li>• Invisalign   Vivera</li> <li>• Study Model/iRecord</li> <li>• No Default</li> </ul> <p><b>Note:</b> The list of available procedures changes according to your iTerio subscription package.</p>

3. Tap  to save the changes and return to the *Settings* window.

### 4.6.2.3 Defining the signature settings

You can define the default settings that are displayed when sending an order to the lab.

**To define the signatures settings:**

1. Tap the **Signature Settings** button.

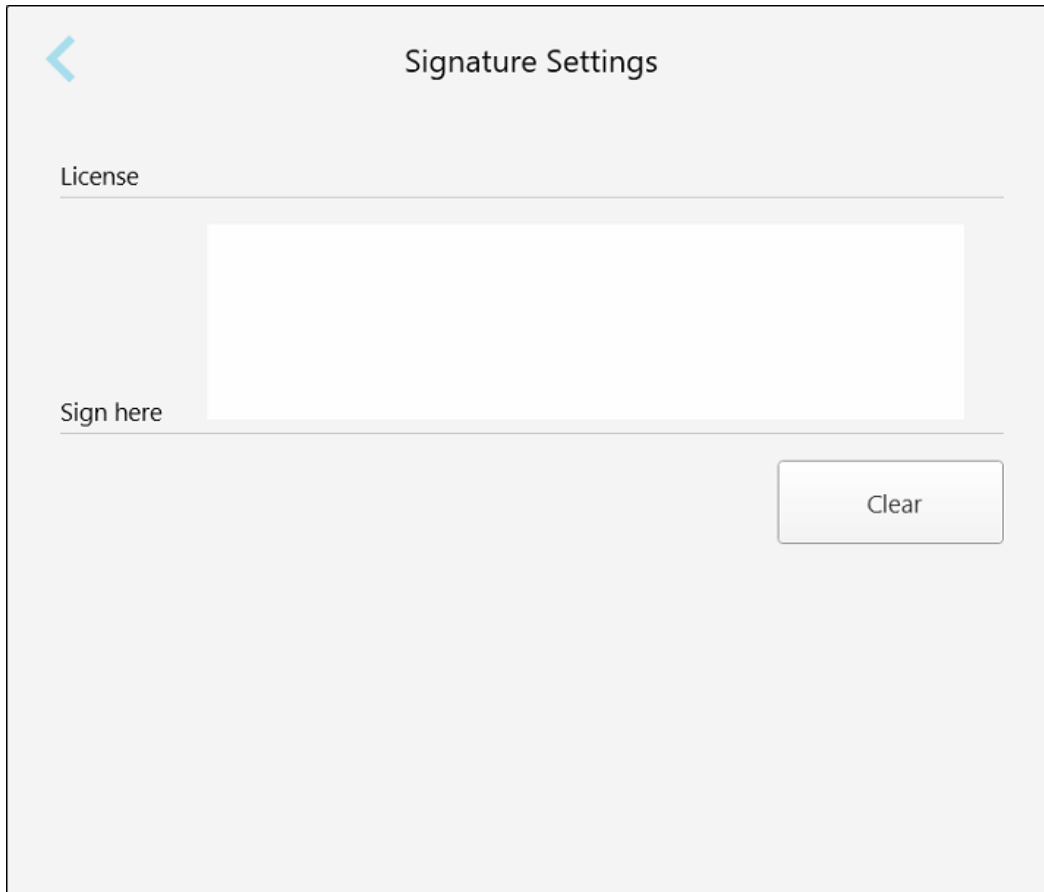



Figure 67: Signature Settings window

2. Define the default signature settings.

Signature setting	Signature options
License	Add your license number.
Sign here	Add your signature.

3. Tap  to save the changes and return to the *Settings* window.

#### 4.6.2.4 Defining the localization settings

You can define the default scanner language and the date format to be used in the Rx and displayed in all related windows.

**To define the localization settings:**

1. Tap the **Localization** button.

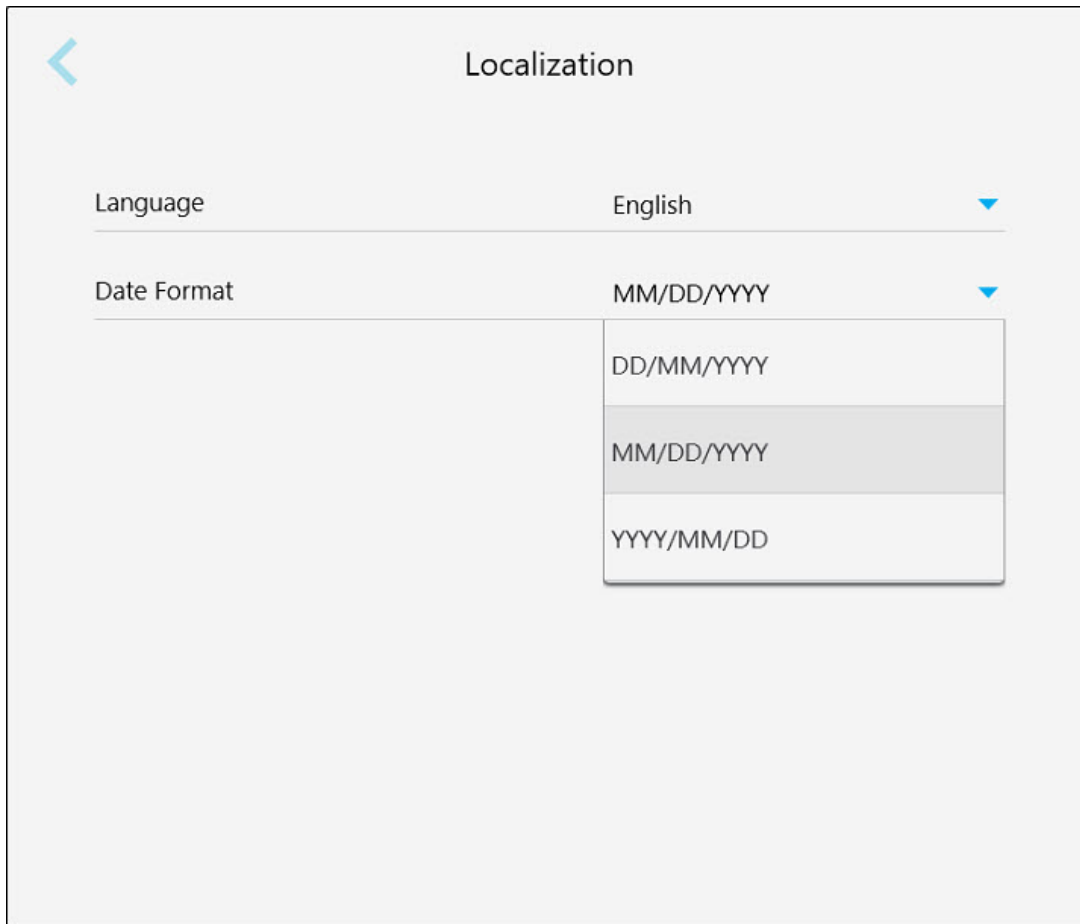



Figure 68: Localization window

2. Select the required scanner language from the **Language** drop-down list.
3. Select the required date format to be used in the Rx and all related windows from the **Date Format** drop-down list.
4. Tap  to save the changes and return to the *Settings* window.

### 4.6.3 Defining the System settings

The System settings enable you to set the login settings, run diagnostics, view the licenses, view the system information, and synchronize new updates from the server.

#### 4.6.3.1 Defining the login settings

In order to comply with privacy and security regulations, you will be logged out of the scanner after a predefined period of inactivity. By default, this time is set to 1 hour, but you can change it if required.

**Notes:**

- To ensure patient privacy, it is recommended to not increase the inactivity period to more than the default 1 hour.
- You will not be logged out of the scanner while the scanner is in Scan mode.

**To define the period of inactivity:**

1. Tap the **Login Settings** button.

The *Login Settings* window is displayed.

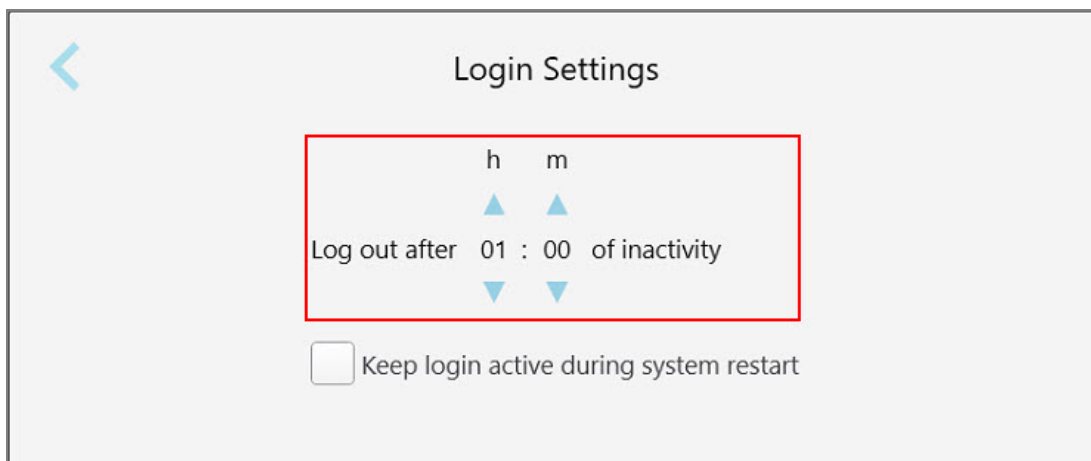



Figure 69: Login Settings window

2. Select the period of inactivity after which the user will be logged out of the scanner. (Min time: 10 minutes, Max time: 8 hours)
3. Select the **Keep login active during system restart** check box to remember the user's password if the system restarts before the inactivity logout period has elapsed.
4. Tap  to save the changes and return to the *Settings* window.

### 4.6.3.2 Running diagnostics

Tap the **Diagnostics** button to check the network connection and speed.

**To run system diagnostics:**

1. Tap the **Diagnostics** button.

The network connection and speed are checked.

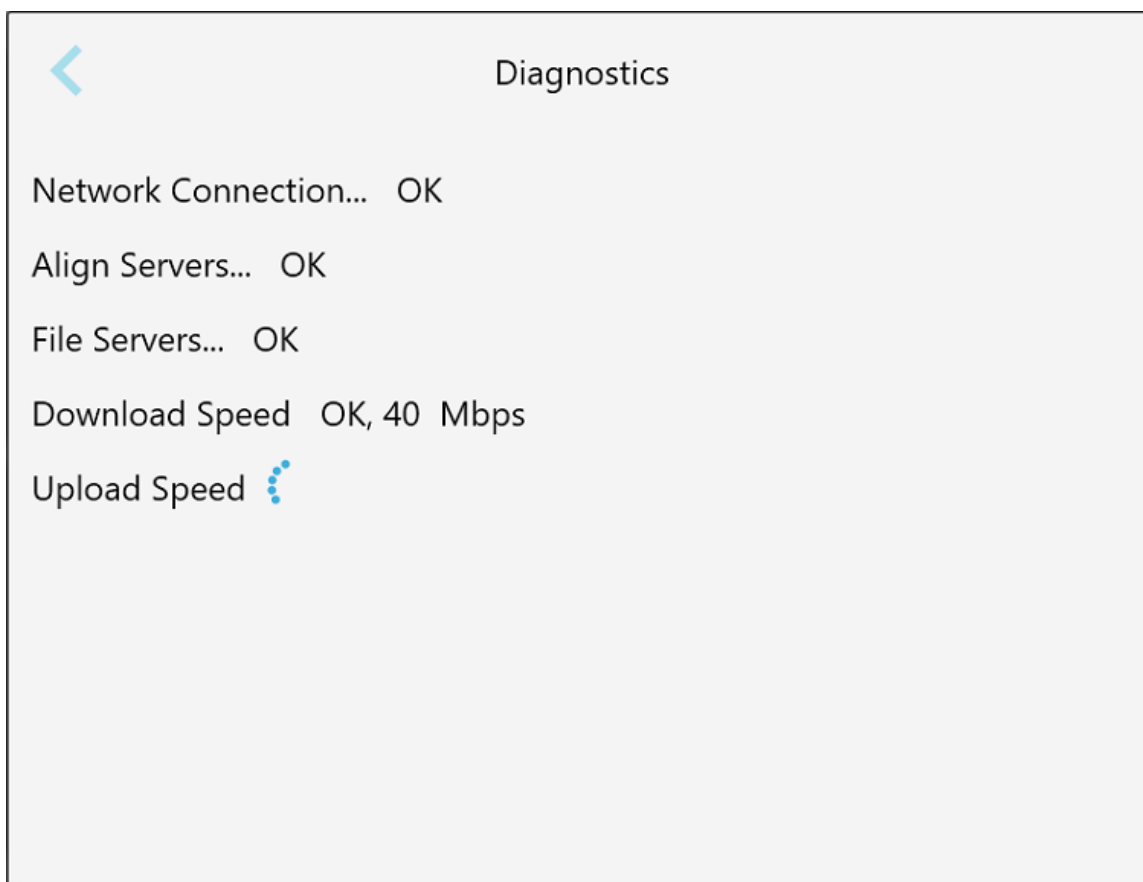



Figure 70: Diagnostics window

2. Tap  to return to the *Settings* window.

### 4.6.3.3 Licenses

Tap the **Licenses** button to view a list of third-party software components installed on the scanner and then tap  to return to the *Settings* window.

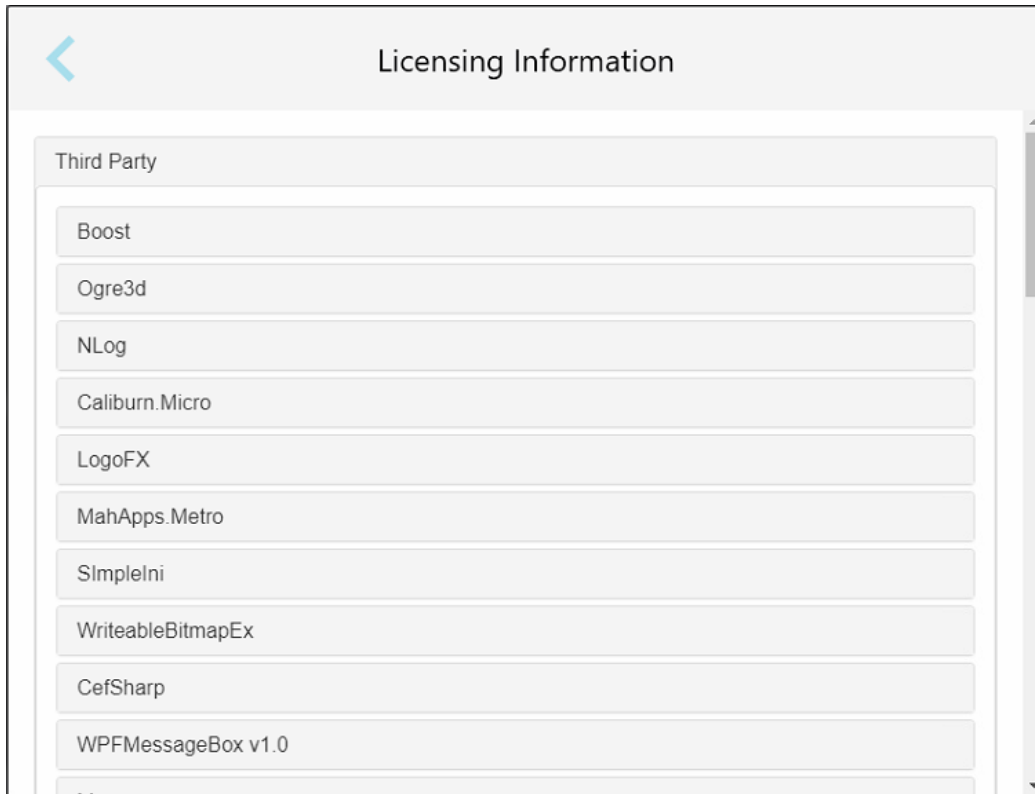



Figure 71: Licensing Information window

#### 4.6.3.4 System information

Tap the **System Information** button to view details about the software versions currently installed and the hardware serial numbers and ID, and then tap  to return to the *Settings* window.

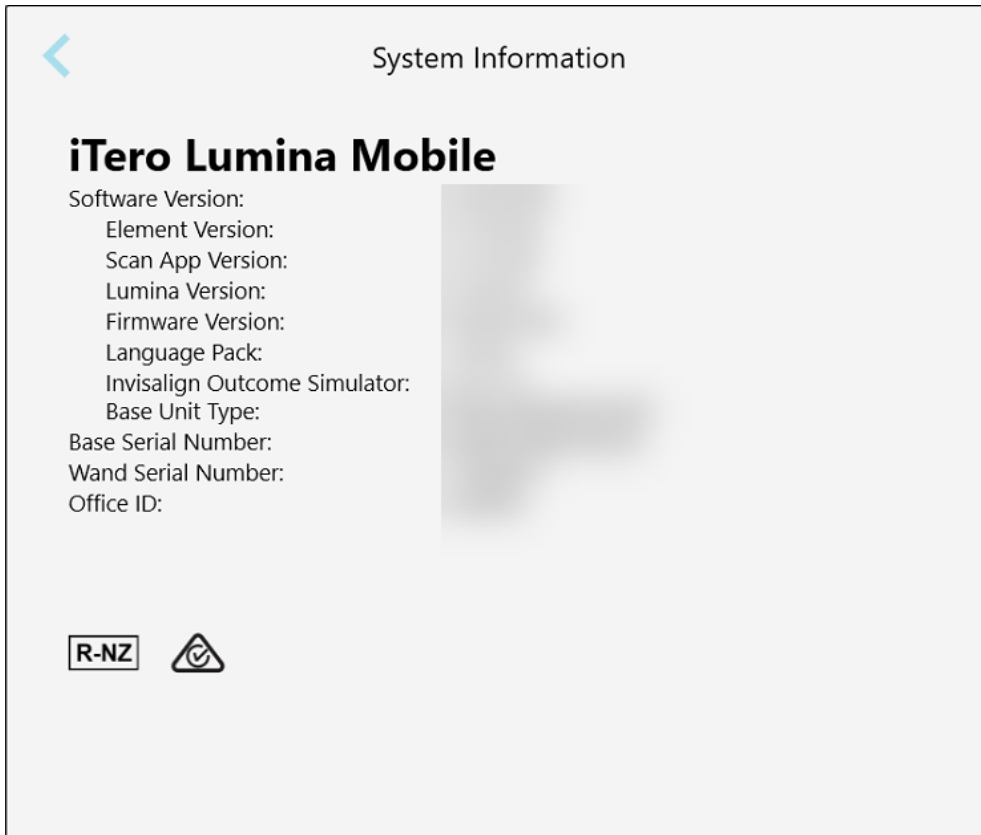

Figure 72: System Information window – iTero Lumina mobile configuration

#### 4.6.3.5 Sync configuration

Tap the **Sync Configuration** button to synchronize any new updates from the server, for example, new software options.

## 5 Starting a new scan

Before starting a new scan, you must:

- Check whether there are any particles on the wand. If so, repeat the cleaning and disinfection process, described in [Cleaning and disinfecting the wand](#).
- Apply a new sleeve to reduce the risk of cross-contamination, as described below.
- Fill in the Rx form in the *New Scan* window.
  - Enter the details of a new patient into your iTero system, described in [Adding new patients](#), or search for an existing patient, described in [Searching for existing patients](#).
  - Enter the details of the procedure required, described in [Filling in the Rx](#).

### 5.1 Applying a sleeve

**To apply a wand sleeve:**

1. Gently remove the dark protective sleeve from the wand.

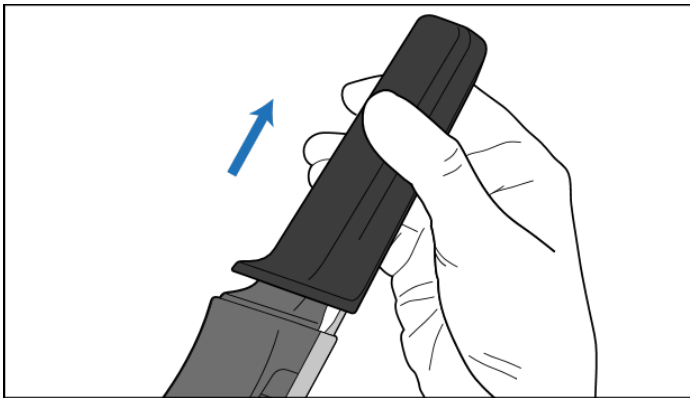

Figure 73: Remove the protective sleeve

2. Gently slide a new sleeve onto the tip of the wand until it clicks into place.

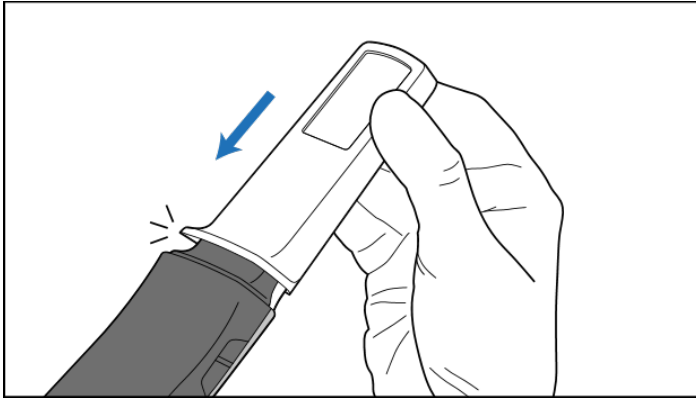

Figure 74: Gently slide the new sleeve into place

**Note:** Do not touch the sleeve window.

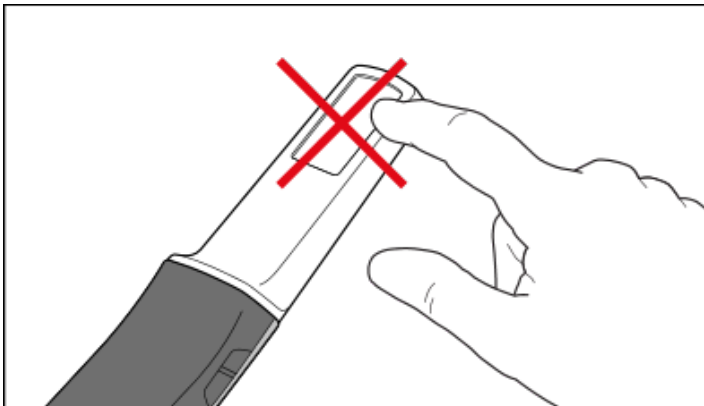
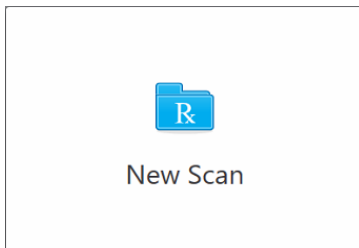

Figure 75: Do not touch the sleeve window

## 5.2 Starting the scanning process

On the home screen, tap the **New Scan** button to start the scanning process.



The *New Scan* window is displayed, as well as a toolbar that shows your progress throughout the scanning process.

Figure 76: New Scan window showing an empty Rx form and progress toolbar

The *New Scan* window shows the Rx form, which is made up of the following areas:

- **Doctor:** Displays the doctor's name and license number.
- **Patient:** Enables you to add a new patient to your iTerio system or search for an existing patient for whom to prescribe the treatment. Once the patient's details are displayed, you can edit them, or clear the details from the *New Scan* window. For more information, see [Patient management](#).
- **Order:** Enables you to define the details of the required procedure, for example, Invisalign | Viverra.
- **Scan Options:** Enables you to turn on toggles regarding, for example, whether the order should include a multi-bite scan.
- **Notes:** Enables you to enter any specific notes to the lab regarding the patient's treatment. For example, you can write special instructions for delivery or manufacturing. After entering your note, tap anywhere outside the **Notes** area to add the note. Each note shows the author of the note, with a timestamp, and can be edited and deleted.

Additional areas and options may be displayed, depending on the procedure and procedure type selected in the **Order** area.

The scanning process requires the following steps, which are displayed on the toolbar:



[Filling in the Rx](#)



[Scanning the patient](#)



[Viewing the scan](#)



[Sending the scan](#)

Your current progress is highlighted on the toolbar.

### 5.3 Filling in the Rx

The first step in the scanning process is filling in the Rx (prescription) form. The *New Scan* window has a simple, intuitive workflow that fulfills all restorative and orthodontic application needs. It enables efficient collaboration with the labs and reduced back and forth by ensuring that all information required by the lab for production is included.

After entering the patient details, you can enter the details about the required procedure and procedure type, if relevant, as well as enter notes for the lab regarding the scan. Fields marked with a red asterisk are mandatory before scanning.

**Note for Fixed Restorative and Denture/Removable procedures:** Some fields become mandatory only after scanning, before sending the scan.

The screenshot shows the 'New Scan' window with the following fields and options:

- Doctor:** Dr. Demo, Demo; License: 12345
- Patient:** Search icon, Clear button, First Name: \*, Last Name: \*, Date of Birth:, Gender: Male Female, Chart Number:
- Order:** Procedure \*, Type, Due Date:, Send to
- Scan Options:** New Sleeve Attached:
- Notes:** Add Note

Figure 77: New Scan window

#### To fill in the Rx:

1. In the **Patient** area, enter the first name and last name of the new patient.  
If required, enter the patient's date of birth, gender, and a unique chart number.

Or

Tap  to search for an existing patient, as described in [Searching for existing patients](#).

- In the **Order** area, from the **Procedure** drop-down list, select the required procedure.

**Note:** The list of procedures displayed depends on your iTero subscription package.

**Figure 78: Selecting the required procedure**

The following procedures are available by default, depending on whether you have a Restorative or Orthodontic subscription package:

- **Study Model/iRecord:** A simple scan with no additional modification, mainly used for studying purposes and referencing instead of storing the plaster model, as required by law. It can also be scanned as iCast, and is available on your Invisalign Doctor Site. For more information, see [Filling in the Rx for Study Model/iRecord procedures](#).
- **Invisalign | Vivera:** The basic scan for all Invisalign treatments, including retainers. For more information, see [Filling in the Rx for Invisalign | Vivera procedures](#).
- **Fixed Restorative\*:** A scan for all restorative treatments, for example, crowns and bridges. For more information, see [Filling in the Rx for Fixed Restorative procedures](#).
- **Implant Planning\*:** Enables ordering a surgical guide from the lab. For more information, see [Filling in the Rx for Implant Planning procedures](#).
- **Denture/Removable\*:** Enables comprehensive planning and fabrication of partial and full dentures. For more information, see [Filling in the Rx for Denture/Removable procedures](#).
- **Appliance:** A scan for various dental appliances, for example, night guards and Apnea/Sleep appliances. For more information, see [Filling in the Rx for Appliance procedures](#).

The **Order** and **Scan Options** areas of the *New Scan* window are displayed according to the selected procedure.

- If relevant, from the **Type** drop-down list, select the procedure type required.  
**Note:** Procedure types are not relevant for Study Model/iRecord and Fixed Restorative procedures.
- If required, tap the calendar in the **Due Date** field and then select the date the case is due back from the lab.
- From the **Send To** drop-down list, select the lab to which the scan should be sent, your chairside milling software, or your MyiTero account.

\*Subject to regulatory or other required approvals and commercial availability in your country/region.

6. Depending on the procedure selected, fill in the relevant additional details.
7. In the **Scan Options** area, turn on/off the following toggles, depending on the procedure selected, as required.
  - **New Sleeve Attached:** Turn on the **New Sleeve Attached** toggle to confirm that a new sleeve has been attached. For more information, see [Confirming a new sleeve between patients](#).
  - **Multi-Bite:** Turn on the **Multi-Bite** toggle if a multi-bite scan is required. This enables you to preserve the 2-bite relation based on your needs, and delivers comprehensive bite information to the lab for appliance fabrication.

**Notes:**

- For Invisalign from Study Model/iRecord procedures, it is recommended that the first bite is scanned bilaterally. Only the first bite will be used in the ClinCheck software.
  - When scanning a Fixed Restorative procedure, you can select up to 5 additional bites.
- **Pre-Treatment Scan:** Turn on the **Pre-Treatment Scan** toggle if you would like to scan the patient before prepping the relevant tooth. In this case, the patient must be scanned twice – before and after the tooth has been prepped. The pre-treatment scan enables the lab to copy the original anatomy to the new restoration.
  - **Emergence Profile:** Turn on the **Emergence Profile** toggle if you would like to scan the emergence profile before attaching the scan body. In this case, the patient must be scanned twice – before and after the scan body has been attached.
  - **Denture Copy Scan:** Turn on the **Denture Copy Scan** toggle if you would like to include a scan of the existing dentures or temporary dentures.
8. Depending on the procedure and procedure type selected, enter the relevant details in the additional areas that are displayed, for example, the **Tooth Diagram** area or the **Denture Details** area.
  9. In the **Attachments** area, turn on the toggle if you would like to upload videos, images, etc. from MyiTero, after sending the scan. In this case, the order will be on hold until it is sent via MyiTero.
 

**Note:** The **Attachments** area is not relevant for Invisalign | Viverra procedures.
  10. In the **Notes** area, if required, enter any specific notes to the lab regarding the patient's treatment. For example, special instructions for delivery or manufacturing. After entering your note, tap anywhere outside the **Notes** area to add the note. Each note shows the author of the note, with a timestamp, and can be edited and deleted.

11. Tap  on the toolbar to move to Scan mode to scan the patient, as described in [Scanning the patient](#).

### 5.3.1 Filling in the Rx for Study Model/iRecord procedures

The **Study Model/iRecord** procedure requires a simple scan without any additional modification.

If you are an Invisalign doctor, all scans will be uploaded to the Invisalign Doctor Site and will be available in the ClinCheck software.

**To fill in the Rx for a Study Model/iRecord procedure:**

1. In the **Patient** area, enter a patient's details or search for an existing patient, as described in [Searching for existing patients](#).

- In the **Order** area, select **Study Model/iRecord** from the **Procedure** drop-down list.

The *New Scan* window expands to display an **Attachments** area and is displayed as follows:

The screenshot shows the 'New Scan' window with the following sections:

- Doctor:** Dr. Demo, Demo; **License:** 12345
- Patient:** Search bar with 'Clear' button. Fields for First Name (\* Patient), Last Name (\* Demo), Date of Birth, Gender (Male/Female), and Chart Number.
- Order:** A blue banner states 'All Study Model/iRecord scans are available for Invisalign.' Below, the Procedure dropdown is set to 'Study Model/iRecord', and the Ortho Model/iCast toggle is turned off. There is also a Due Date field and a Send to dropdown.
- Scan Options:** New Sleeve Attached (toggle off) and Multi-Bite (toggle off).
- Attachments:** Text input for uploading videos, images, X-rays, etc. A toggle below reads 'I would like to upload files later via MyiTero' (toggle off).
- Notes:** A text area with an 'Add Note' button.

Figure 79: Order and Attachment areas – Study Model/iRecord procedure

- If required, turn on the **Ortho Model/iCast** toggle to order a digital dental case.
- Continue filling in the prescription from step 4, **Due Date**, as described in [Filling in the Rx](#).

### 5.3.2 Filling in the Rx for Invisalign | Vivera procedures

The Invisalign | Vivera procedure is used to create prescriptions for all Invisalign orders, including retainers. The model must be scanned without any holes to ensure that the aligners are a perfect fit with the patient's teeth.

**To fill in the Rx for an Invisalign | Vivera procedure:**

- In the **Patient** area, enter a patient's details or search for an existing patient, as described in [Searching for existing patients](#).
- In the **Order** area, select **Invisalign | Vivera** from the **Procedure** drop-down list.

The *New Scan* window is displayed as follows:

Figure 80: Order area – Invisalign | Viverra procedure

3. From the **Type** drop-down list, select the type of Invisalign procedure required, depending on your iTerO subscription package:
  - Invisalign Aligners – Invisalign Outcome Simulator Pro is available only for **Invisalign Aligners** procedure types. For more information on Invisalign Outcome Simulator Pro, see [Invisalign Outcome Simulator Pro](#).
  - Invisalign First Aligners
  - Invisalign Palatal Expander
 

**Note:** Excess soft tissue will not be removed automatically from around the edges of the model during scanning. If required, you can enable automatic cleanup by pressing on the screen and then tapping the Auto Cleanup tool. For more information, see [Disabling auto-cleanup](#).
  - Viverra Retainer – maintains the position of the teeth after treatment. If brackets are still present, they will be removed by the iTerO software. The Viverra retainers will be provided at the debonding appointment.
  - Invisalign Retainer
4. For Invisalign Aligners, First Aligners, and Palatal Expanders, you can select the **Treatment Stage**:
  - Initial Record – for the first Invisalign treatment scan. By default, the Current Aligner # is set to 0.
  - Progress Record – for multiple scans during the ongoing treatment. In addition, enter the patient's current Aligner number in the **Current Aligner #** field.
  - Final Record – for the scan done when treatment is completed. In addition, enter the patient's current Aligner number in the **Current Aligner #** field.

5. Continue filling in the prescription from step 7, **Scan Options**, as described in [Filling in the Rx](#).

For more information, refer to the Invisalign documentation.

### 5.3.3 Filling in the Rx for Fixed Restorative procedures

The Fixed Restorative procedure covers a range of restorations, including crowns, bridges, veneers, inlays, onlays, and implant-based restoration. When selecting fixed restorative procedures, you need to select the tooth that needs to be restored, the type of restoration required, as well as the material, shade, etc. of the restoration.

**Note:** Some fields are not mandatory before scanning the patient but must be filled in before you can send the scan.

#### To fill in the Rx for a Fixed Restorative procedure:

1. In the **Patient** area, enter a patient's details or search for an existing patient, as described in [Searching for existing patients](#).
2. In the **Order** area, select **Fixed Restorative** from the **Procedure** drop-down list.

The **New Scan** window expands and a **Tooth Diagram** area showing the tooth numbers and illustrations and an **Attachments** area are displayed in the window.

The screenshot shows the 'New Scan' window with the following sections:

- Doctor:** Dr. Demo, Demo License: 12345
- Patient:** Search and Clear buttons. Fields for First Name (Patient), Last Name (Demo), Date of Birth, Gender (Male/Female), and Chart Number.
- Order:** Procedure (Fixed Restorative), Type, Due Date, and Send to.
- Scan Options:** Toggles for New Sleeve Attached, Pre-Treatment Scan, Emergence Profile Scan, and Multi-Bite.
- Tooth Diagram:** A grid of 32 tooth icons numbered 1-32, representing the dental arch.
- Attachments:** Upload videos, images, X-rays and other external case-related files via MyiTerO. Includes a toggle for 'I would like to upload files later via MyiTerO'.
- Notes:** Add Note field.

Figure 81: Tooth Diagram, and Attachments areas – Fixed Restorative procedure

- If required, tap the calendar in the **Due Date** field and then select the date the restoration is due from the lab.
- From the **Send To** drop-down list, select the lab to which the scan should be sent, your chairside milling software, or your MyiTerO account.
- In the **Scan Options** area, turn on/off the following toggles, as required.
  - New Sleeve Attached:** Turn on the **New Sleeve Attached** toggle to confirm that a new sleeve has been attached. For more information, see [Confirming a new sleeve between patients](#).

- **Pre-Treatment Scan:** Turn on the **Pre-Treatment Scan** toggle if you would like to scan the patient before prepping the relevant tooth. In this case, the patient must be scanned twice – before and after the tooth has been prepped. The pre-treatment scan enables the lab to copy the original anatomy to the new restoration.
- **Emergence Profile:** Turn on the **Emergence Profile** toggle if you would like to scan the emergence profile before attaching the scan body. In this case, the patient must be scanned twice – before and after the scan body has been attached.
- **Multi-Bite:** Turn on the **Multi-Bite** toggle if you would like to scan additional bites and then select the bite types to scan. You can select up to five additional bite types.

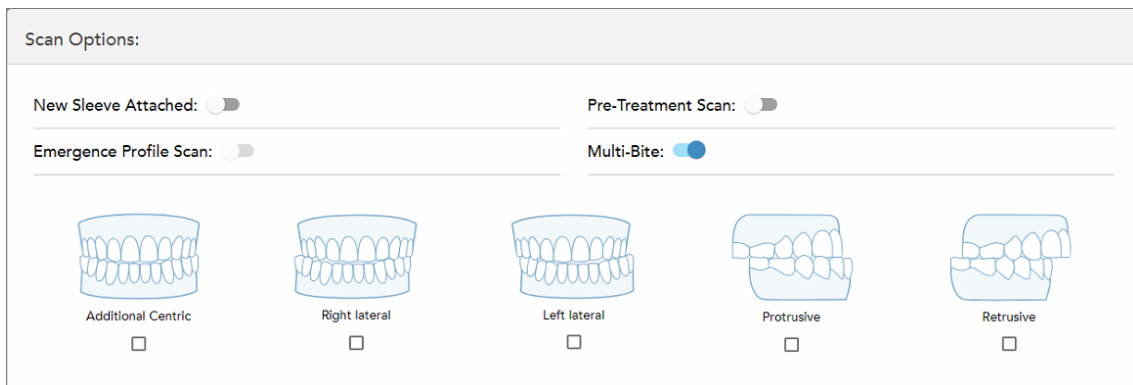

Figure 82: Multi-Bite options

6. In the **Tooth Diagram** area, tap the tooth to be restored.  
A list of available options for the selected tooth is displayed.

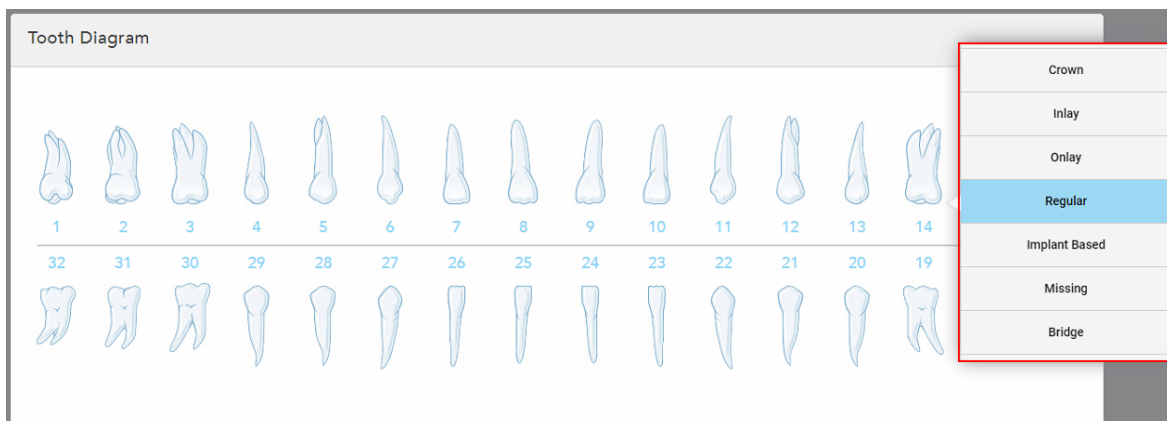

Figure 83: List of fixed restorative treatment options

7. Select the required treatment option.

Depending on the fixed restorative treatment option selected, a treatment window is displayed.

**Note:** Treatment options are mandatory before sending the scan, but can be filled in after scanning.

Figure 84: Treatment settings window – Onlay restoration

8. Select the relevant treatment settings for each tooth, according to the treatment option selected:
  - **Crown**, described in [Crown, Veneer, Laminates, Inlay, and Onlay restorations](#)
  - **Inlay/Onlay** (relevant for molars and premolars only), described in [Crown, Veneer, Laminates, Inlay, and Onlay restorations](#)
  - **Implant Based**, described in [Implant Based restorations](#)

**Note:** If an implant abutment is already in the mouth, select Crown from the drop-down list.

- **Veneers/Laminates** (relevant for the incisors and premolars only), described in [Crown, Veneer, Laminates, Inlay, and Onlay restorations](#)
- **Bridge**, described in [Bridge restorations](#)

In addition:

- If a tooth is missing, tap **Missing**
- To delete a restoration plan, tap **Regular**

9. Tap  to save the selection and return to the *New Scan* window.

The selected teeth are highlighted and the selected treatment options are displayed in the **Treatment Information** area below the **Tooth Diagram** area.

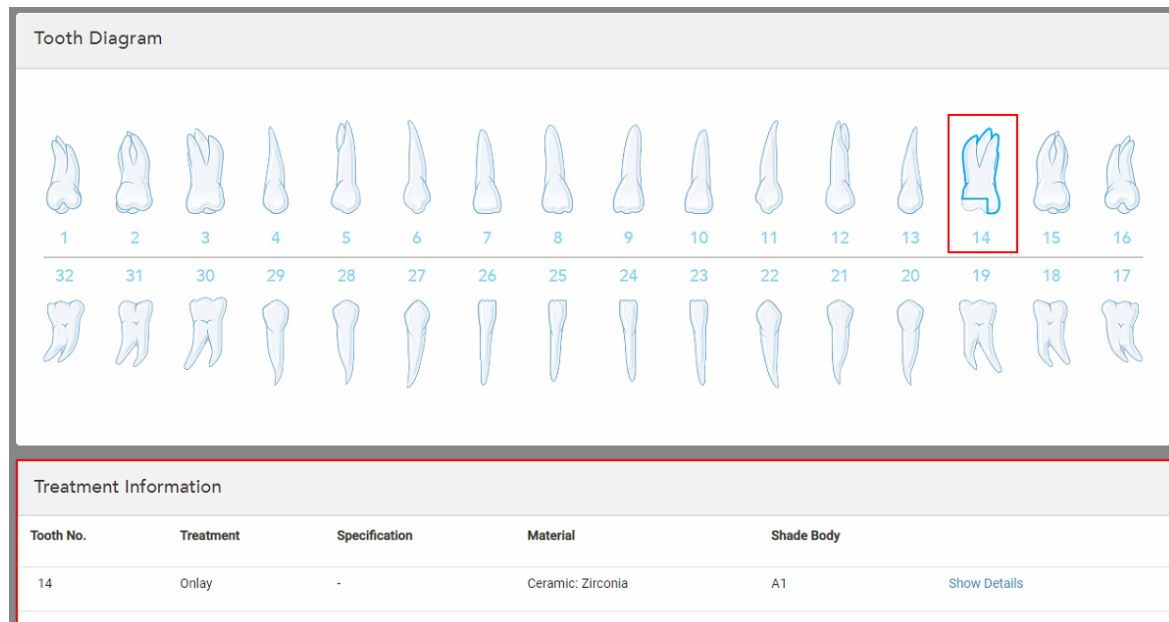

Figure 85: Selected tooth and Treatment Information area – Onlay restoration

You can change the selected treatment options at any time before sending the scan by tapping **Show Details** and editing the settings of a specific tooth.

- In the **Attachments** area, turn on the toggle if you would like to upload videos, images, etc. from MyiTero, after sending the scan. In this case, the order will be on hold until it is sent via MyiTero.
- In the **Notes** area, if required, enter any specific notes to the lab regarding the patient's treatment. For example, special instructions for delivery or manufacturing. After entering your note, tap anywhere outside the **Notes** area to add the note. Each note shows the author of the note, with a timestamp, and can be edited and deleted.

### 5.3.3.1 Crown, Veneer, Laminates, Inlay, and Onlay restorations

Follow the procedure below to complete filling in the Rx for Crown, Veneer, Laminates, Inlay, and Onlay restorations.

**Note:** If more than one tooth requires restoration, you can copy the treatment settings to each tooth requiring the same restoration type.

**To fill in the Rx for a Crown, Veneer, Laminates, Inlay, or Onlay restoration:**

- In the **Tooth Diagram**, tap the tooth that needs restoration and then select the required treatment option from the drop-down list, for example, **Crown**.

The **Crown** treatment settings window is displayed.

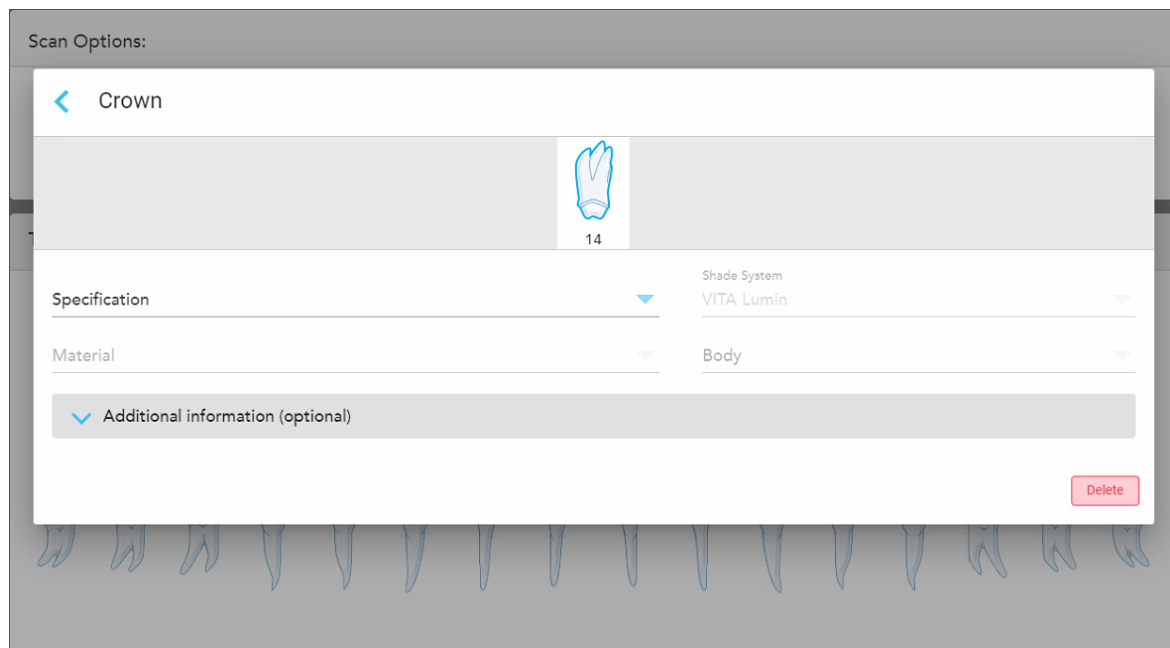

Figure 86: Treatment settings window – Crown restoration

2. Select the following mandatory settings from the relevant drop-down lists:
  - a. **Specification:** The type of crown to be fabricated.

**Note:** Relevant for Crown treatments only. Once you have selected the type of crown required, you can select the rest of the options.
  - b. **Material:** The material from which the restoration should be fabricated, depending on the specification selected. This can be copied to all teeth included in the restoration.

If required, you can save the materials you use the most often as favorites, as described in [Saving list items as favorites](#).
  - c. **Shade System:** The system used for choosing the shade of the restoration.
  - d. **Body:** The shade for the body area of the restoration.

3. If required, tap  to expand the **Additional information** area to display additional optional settings:

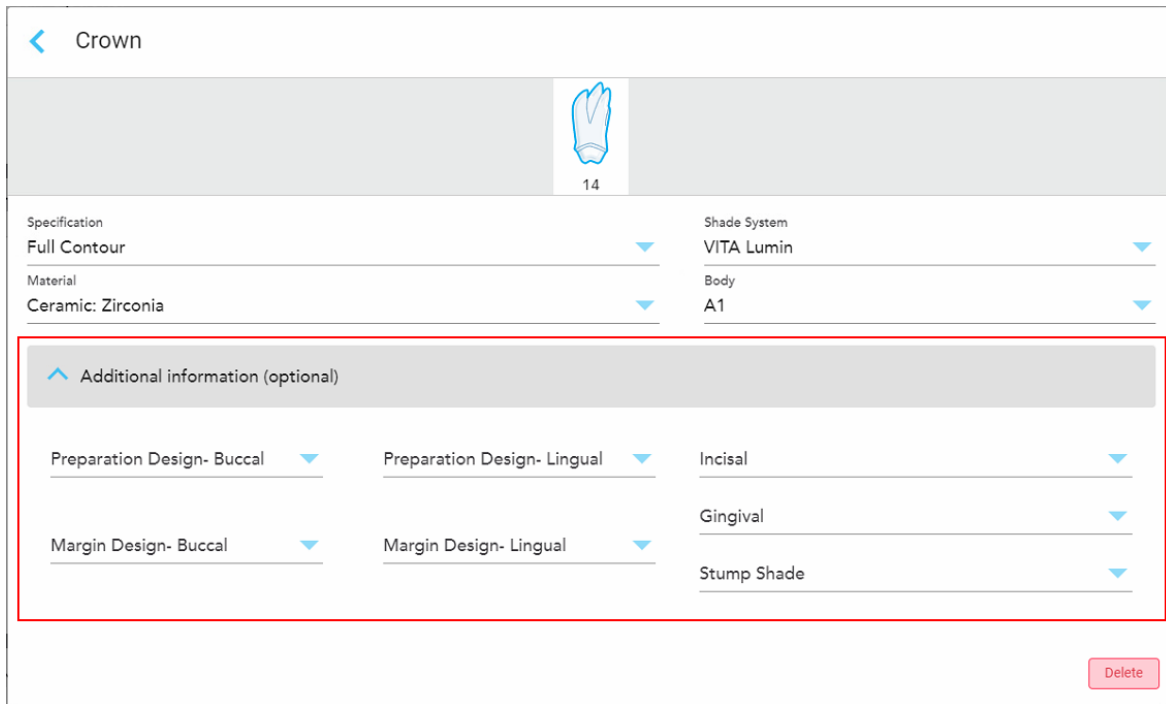

**Figure 87: Additional information area – Crown restoration**

- **Preparation Design (Buccal and Lingual):** The shape of the finishing line (margin line) created by the user during the preparation. You can choose this for both the buccal and the lingual.
  - **Margin Design (Buccal and Lingual):** The type of ceramic-metal border relationship required for the selected metal-based crown. You must choose this for both the buccal and the lingual. This is relevant only for metal dental work.
  - **Incisal:** The shade for the incisal area of the restoration.
  - **Gingival:** The shade for the gingival area of the restoration.
  - **Stump Shade:** The shade of the prepped tooth.
4. Tap  to save the selection and return to the *New Scan* window.

The selected treatment options are displayed in the **Treatment Information** area below the **Tooth Diagram** area. You can change the selected treatment options at any time before sending the scan by tapping **Show Details** and editing the settings of a specific tooth.

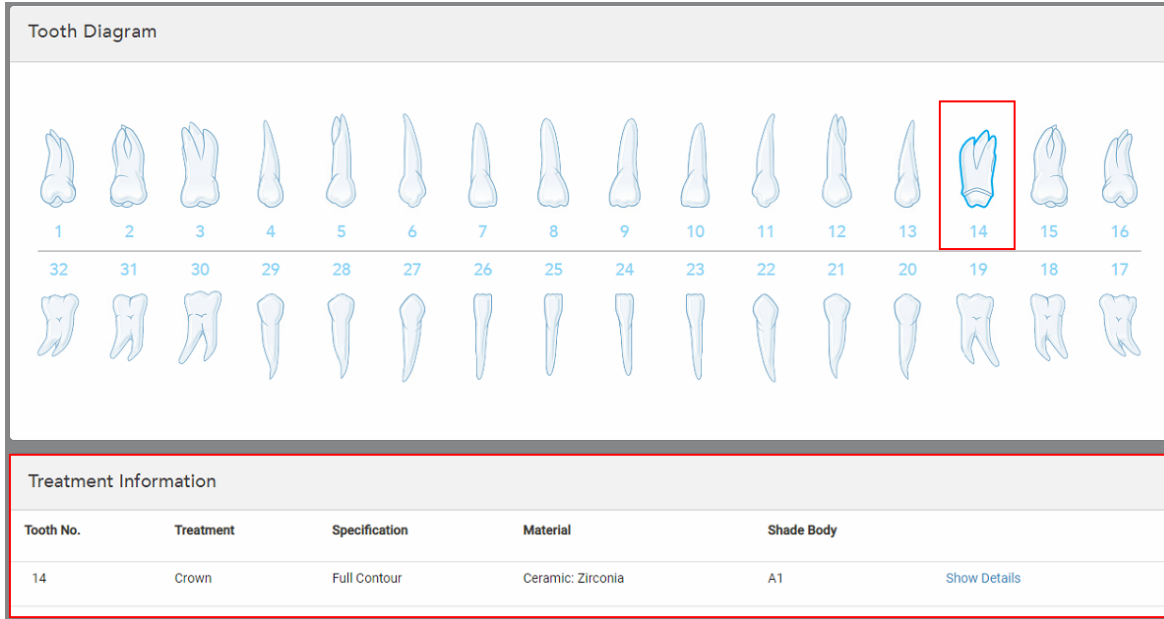

Figure 88: Selected tooth and Treatment Information area – Crown restoration

- Repeat this procedure for each tooth requiring treatment.

If a tooth requires the same treatment as a tooth for which you have already defined the treatment settings, you can copy the settings by tapping the tooth and then selecting **Copy From Tooth #** from the drop-down list.

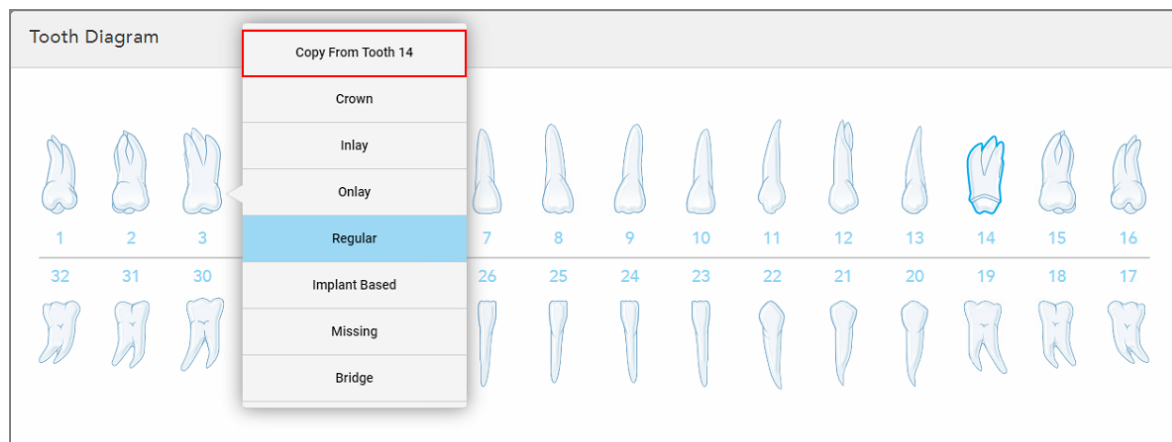

Figure 89: Copy restoration settings from a tooth requiring the same treatment type

The treatment settings are copied to the tooth and are displayed in the **Treatment Information** area below the **Tooth Diagram** area.

- Complete filling in the details in the *New Scan* window, as described in [Filling in the Rx for Fixed Restorative procedures](#).

### 5.3.3.2 Implant Based restorations

Implant Based restorations are created as part of Fixed Restorative procedures, described in [Filling in the Rx for Fixed Restorative procedures](#).

After starting to fill in the Rx for Fixed Restorative procedures, continue with the procedure below for Implant Based restorations.

**Note:** If an implant abutment already exists, you should select the **Crown** restoration, as described in [Crown, Veneer, Laminates, Inlay, and Onlay restorations](#).

**To fill in the Rx for an Implant Based restoration:**

1. In the **Tooth Diagram**, tap the tooth that needs an implant abutment and then select **Implant Based** from the drop-down list.

The **Implant Based** treatment settings window is displayed.

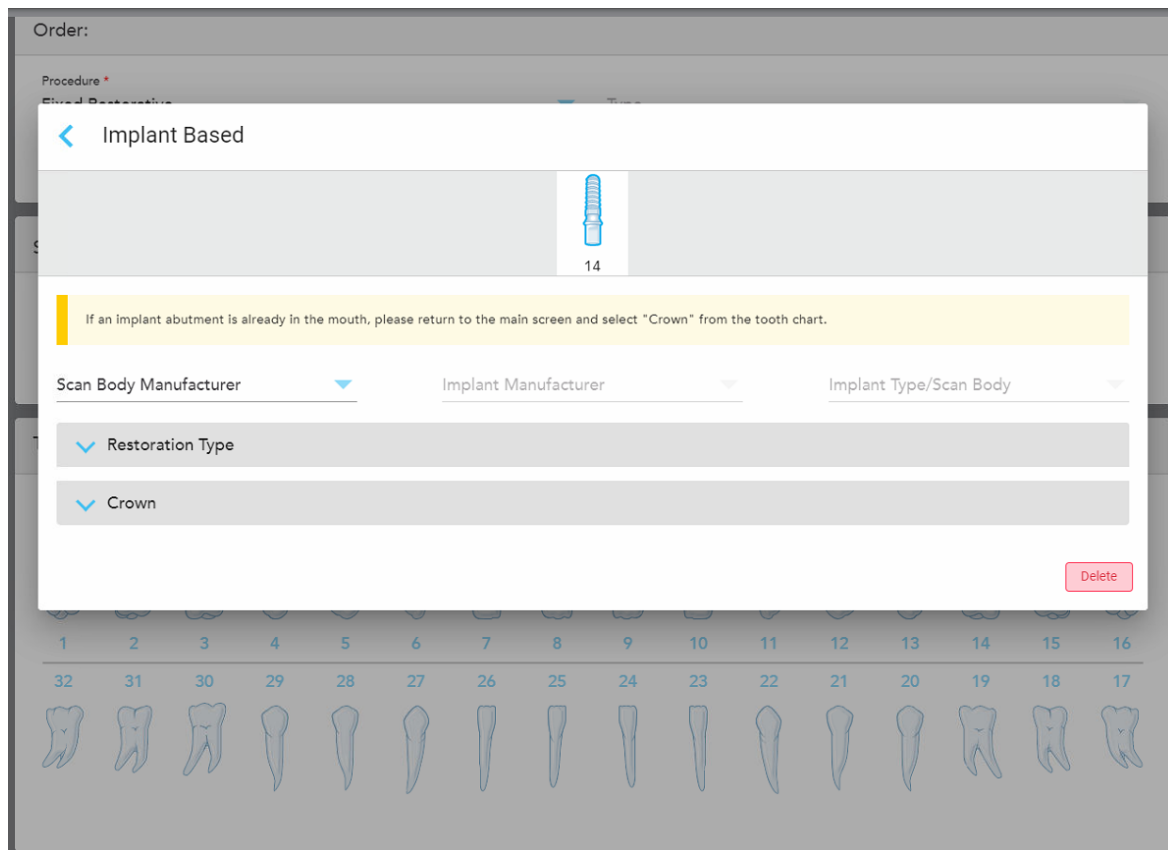



Figure 90: Treatment settings window – Implant Based restoration

2. Select the scan body manufacturer, implant manufacturer, and then the implant type/scan body from the relevant drop-down lists. If required, you can save the scan body and implant manufacturers you use the most often as favorites, as described in [Saving list items as favorites](#).

- Tap  to expand the **Restoration Type** area and then select the restoration type, abutment type, and abutment material from the relevant drop-down lists. If a titanium base is in place, turn on the **Ti-Base** toggle. You can select these options after scanning, but they must be selected before sending the scan.

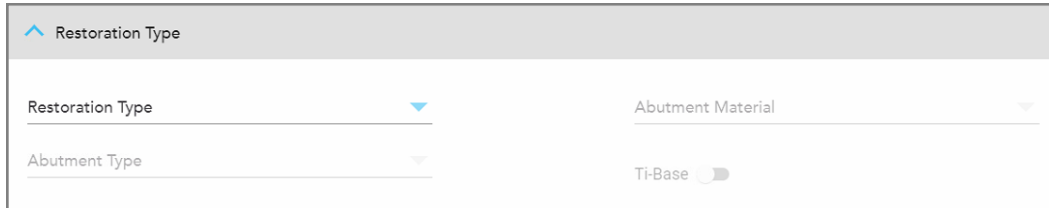



Figure 91: Expanded Restoration Type area

- Tap  to expand the **Crown** area and then select the required settings from the relevant drop-down lists, as described in [Crown, Veneer, Laminates, Inlay, and Onlay restorations](#). You can select these options after scanning, but they must be selected before sending the scan.

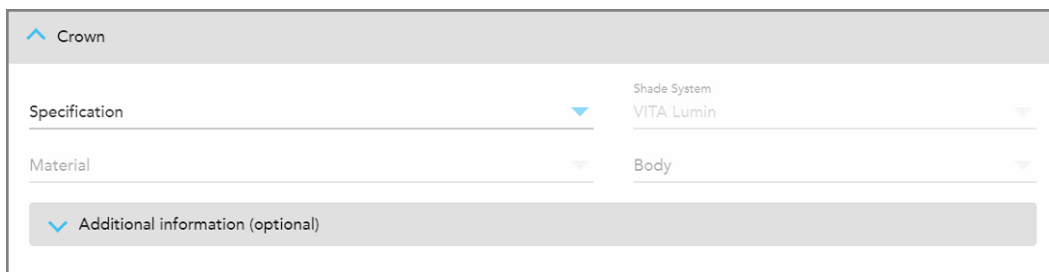



Figure 92: Expanded Crown area

- Tap  to save the selection and return to the *New Scan* window.
- Complete filling in the details in the *New Scan* window, as described in [Filling in the Rx for Fixed Restorative procedures](#).

### 5.3.3.3 Bridge restorations

Follow the procedure below to complete filling in the Rx for Bridge restorations.

#### To fill in the Rx for a Bridge restoration:

- In the **Tooth Diagram** area, tap the first or last tooth in the span of teeth to be included in the bridge and then select **Bridge** from the drop-down list.

The **Bridge** treatment settings window is displayed.

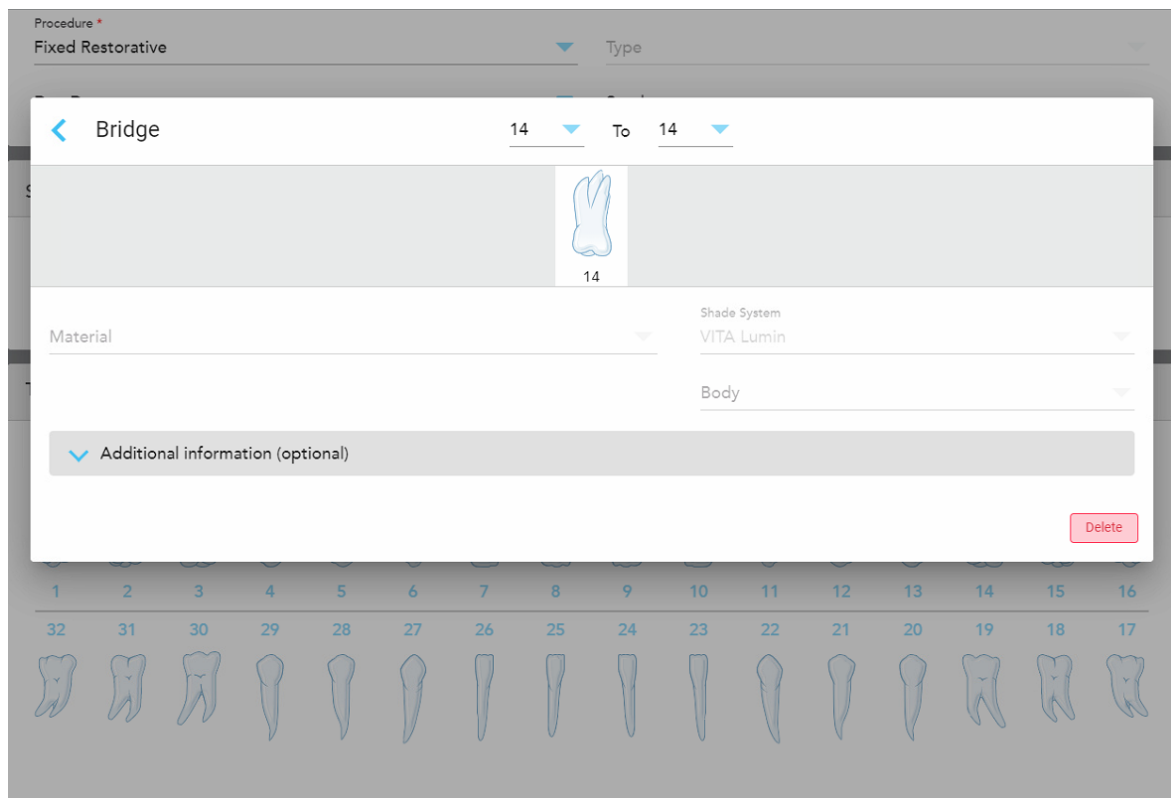

**Figure 93: Treatment settings window – Bridge restoration**

2. Select the span of the teeth to be included in the bridge from the arrows at the top of the window.

The teeth to be included in the bridge are displayed.

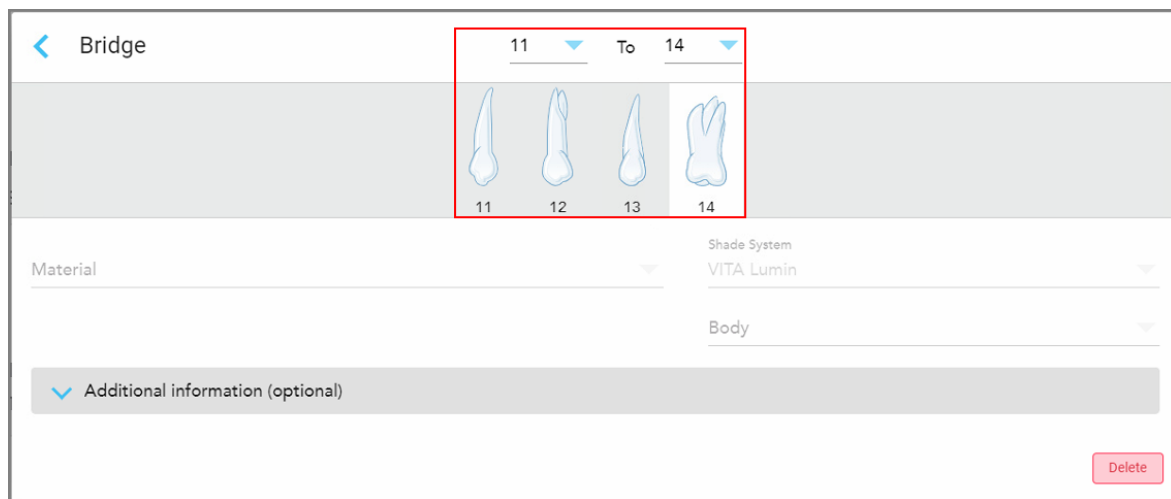

**Figure 94: Bridge range and teeth to be included**

3. Tap each tooth in the tooth range and then select the in-bridge treatment option from the list:

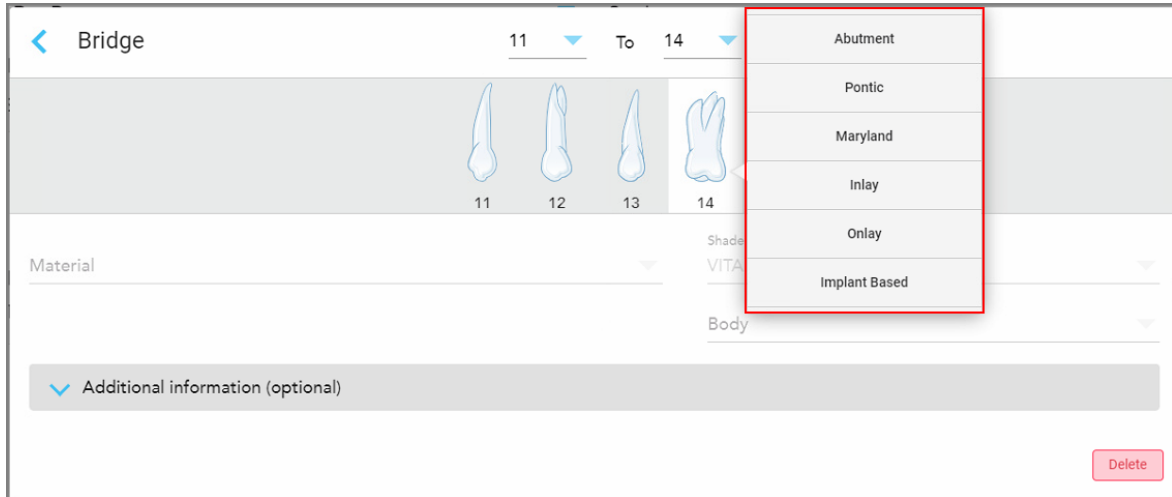

Figure 95: List of in-bridge treatment options

4. For all options besides **Implant Based**:

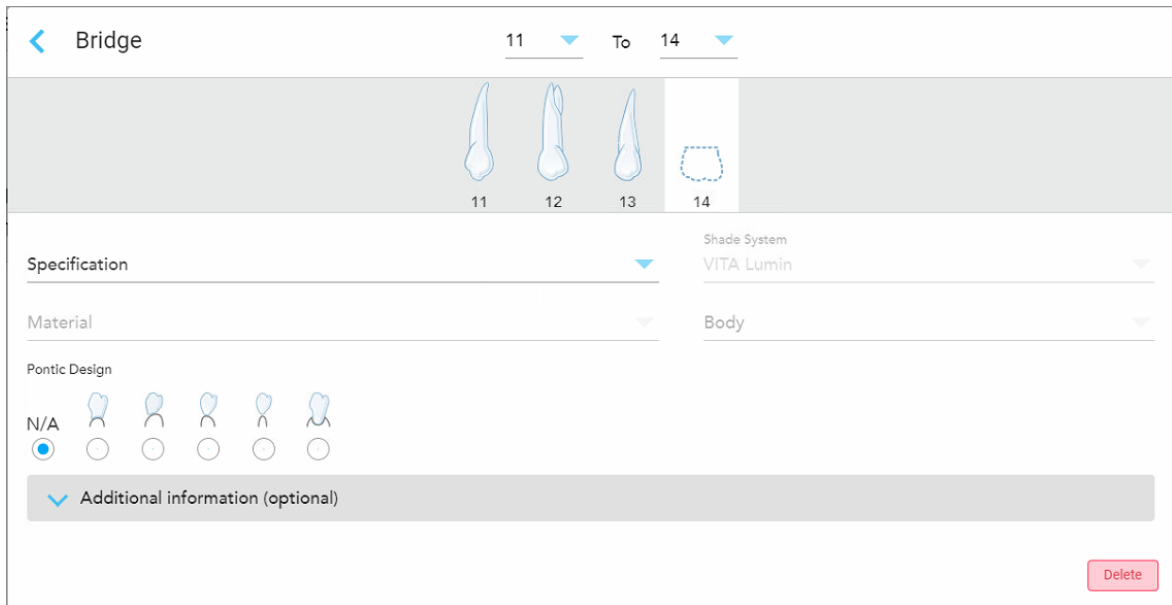

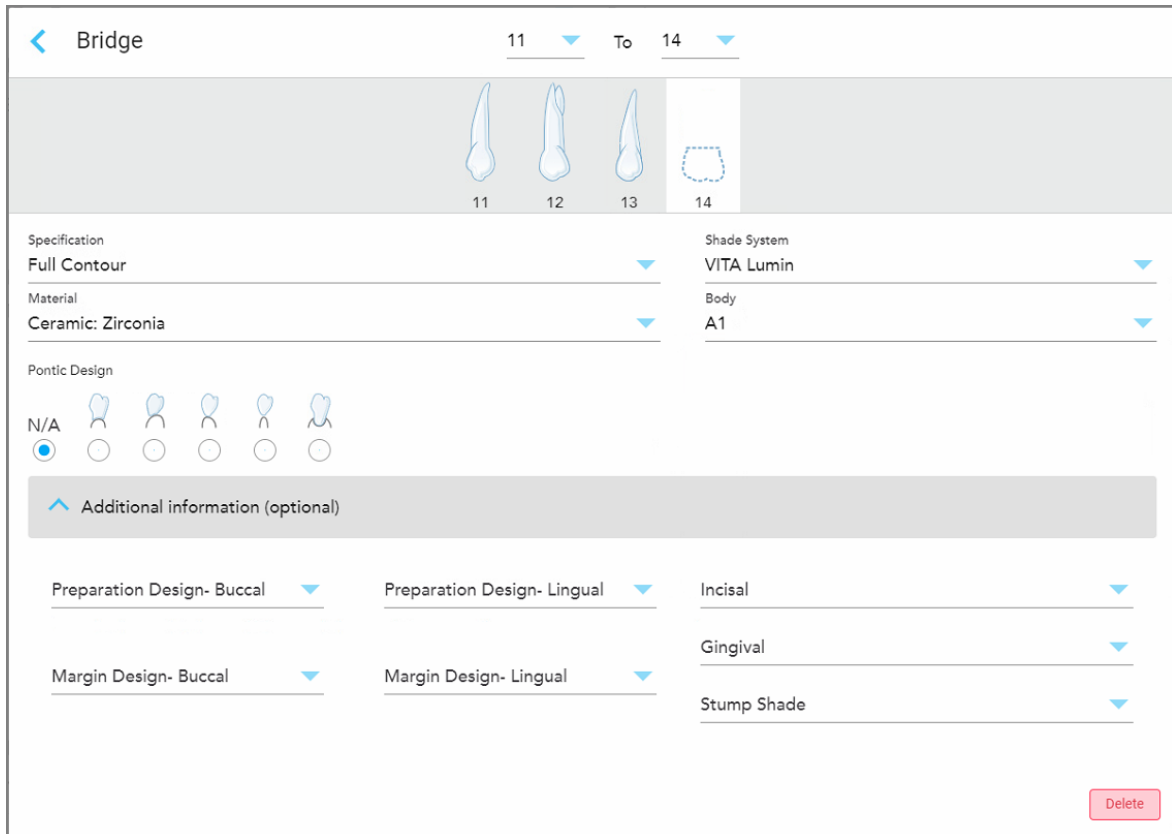

Figure 96: Bridge restoration – Pontic settings

- a. **Specification:** The type of restoration to be fabricated.
- b. **Material:** The material from which the restoration should be fabricated. This is automatically copied to each tooth in the restoration. If required, you can save the materials you use the most often as favorites, as described in [Saving list items as favorites](#).
- c. **Shade System:** The system used for choosing the shade of the restoration.

- d. **Body:** The shade for the body area of the restoration.
- e. **Pontic Design:** Relevant only if **Pontic** was selected as the in-bridge treatment option.
5. If required, tap  to expand the **Additional information** area to display other optional settings:



Bridge

11 To 14

11 12 13 14

Specification  
Full Contour

Material  
Ceramic: Zirconia

Pontic Design  
N/A

Shade System  
VITA Lumin

Body  
A1

Additional information (optional)

Preparation Design- Buccal  
Preparation Design- Lingual  
Incisal

Margin Design- Buccal  
Margin Design- Lingual  
Gingival  
Stump Shade

Delete

Figure 97: Additional information area – Bridge restoration

- **Preparation Design (Buccal and Lingual):** The shape of the finishing line (margin line) created by the user during the preparation. You can choose this for both the buccal and the lingual.
- **Margin Design (Buccal and Lingual):** The type of ceramic-metal border relationship required for the selected metal-based crown. You must choose this for both the buccal and the lingual. This is relevant only for metal dental work.
- **Incisal:** The shade for the incisal area of the restoration.
- **Gingival:** The shade for the gingival area of the restoration.
- **Stump Shade:** The shade of the prepped tooth.

6. If you selected **Implant Based**, the Bridge treatment options are displayed as follows:

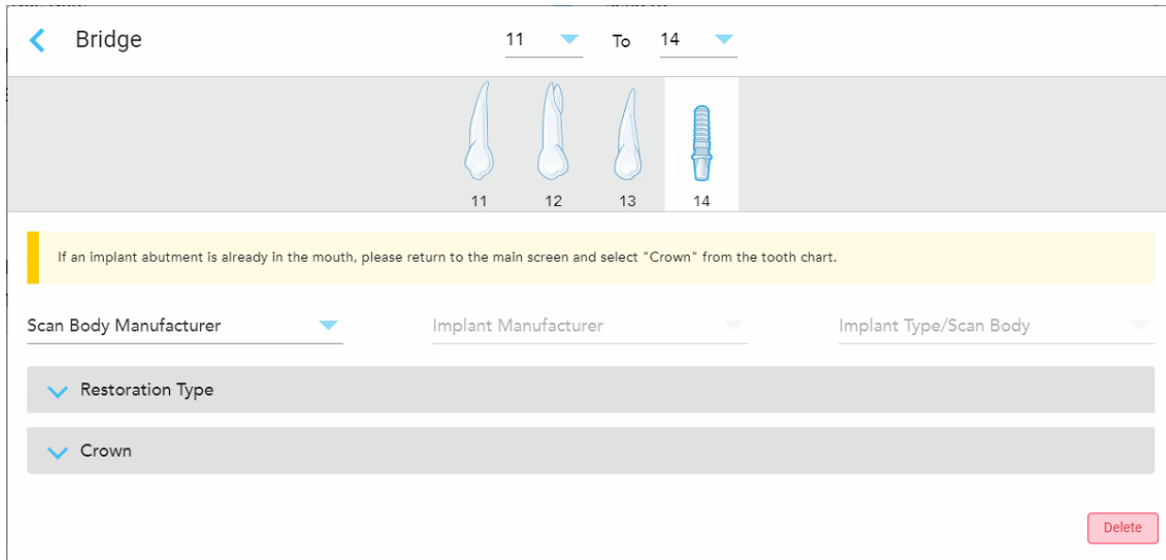



Figure 98: Bridge treatment options – Implant Based

- Select the scan body manufacturer, implant manufacturer, and implant type/scan body from the drop-down lists.
- Tap  to expand the **Restoration Type** area and then select the restoration type, abutment type, and abutment material from the relevant drop-down lists. If a titanium base is in place, turn on the **Ti-Base** toggle.

You can select these options after scanning, but they must be selected before sending the scan.

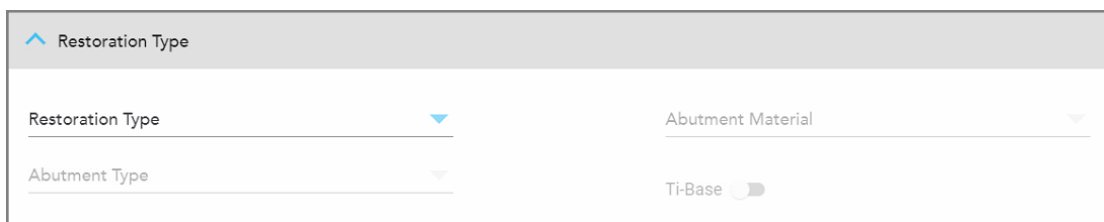



Figure 99: Expanded Restoration Type area

- Tap  to expand the **Crown** area and then select the required settings from the relevant drop-down lists, as described in [Crown, Veneer, Laminates, Inlay, and Onlay restorations](#).

You can select these options after scanning, but they must be selected before sending the scan.

Figure 100: Expanded Crown area

7. Tap  to save the selection and return to the *New Scan* window.
8. Complete filling in the details in the *New Scan* window, as described in [Filling in the Rx for Fixed Restorative procedures](#).

### 5.3.4 Filling in the Rx for Implant Planning procedures

The **Implant Planning** procedure enables efficient communication with the labs regarding surgical-guide prescription requirements. If required, orders can also be sent to your chairside milling software and seamlessly imported directly into exoplan™ or other chairside planning software.

**To fill in the Rx for an Implant Planning procedure:**

1. In the **Patient** area, enter a patient's details or search for an existing patient, as described in [Searching for existing patients](#).
2. In the **Order** area, select **Implant Planning** from the **Procedure** drop-down list.
3. From the **Type** drop-down list, select the type of surgical guide required:

Figure 101: Implant Planning procedure types

The *New Scan* window expands to show the **Tooth Diagram** and **Attachments** areas:

The screenshot shows the 'New Scan' window with the following sections:

- Doctor:** Dr. Demo, Demo; **License:** 12345
- Patient:** Search and Clear buttons; **First Name:** Patient; **Last Name:** Demo; **Date of Birth:**; **Gender:** Male (selected), Female; **Chart Number:**
- Order:** **Procedure:** Implant Planning; **Type:** Surgical Guide Tooth Supported; **Due Date:** (calendar icon); **Send to:** (dropdown)
- Scan Options:** **New Sleeve Attached:** (toggle)
- Tooth Diagram:** A grid of 16 tooth icons, numbered 1-16 in the top row and 32-17 in the bottom row.
- Attachments:** Upload videos, images, X-rays and other external case-related files via MyiTero; **I would like to upload files later via MyiTero:** (toggle)
- Notes:** Add Note

**Figure 102: Implant Planning procedure – Tooth Diagram and Attachment areas for Surgical Guide Tooth Supported**

4. If required, tap the calendar in the **Due Date** field and then select the date the plan is due.
5. From the **Send To** drop-down list, select the lab to which the scan should be sent, your chairside milling software, or your MyiTero account.
6. In the **Scan Options** area, turn on/off the following toggles, as required.
  - **New Sleeve Attached:** Turn on the **New Sleeve Attached** toggle to confirm that a new sleeve has been attached. For more information, see [Confirming a new sleeve between patients](#).

- In the **Tooth Diagram** area, select each tooth to be implanted and select **Implant Position** from the drop-down list.

If you selected **Surgical Guide Tooth Supported** as the procedure type, you can also select each supporting tooth and then select **Supporting Tooth** from the drop-down list. Supporting teeth are displayed in the **Tooth Diagram** area with a line under them.

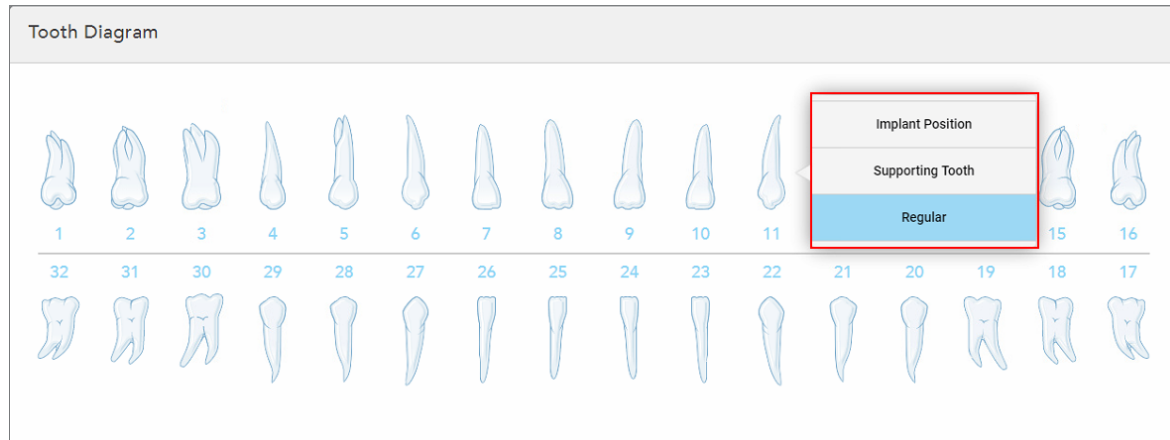

Figure 103: Defining the teeth that need to be implanted

For each tooth selected to be implanted, the *Implant Position* window is displayed.

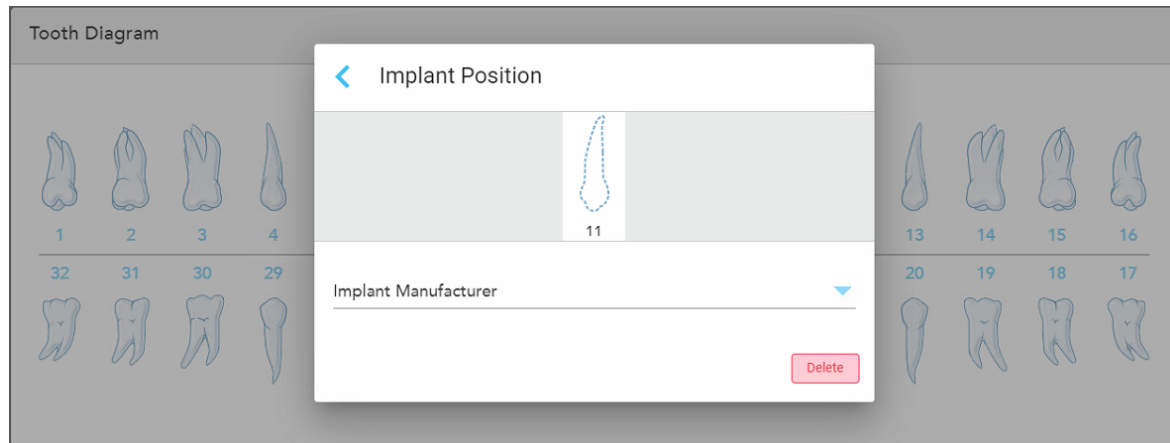

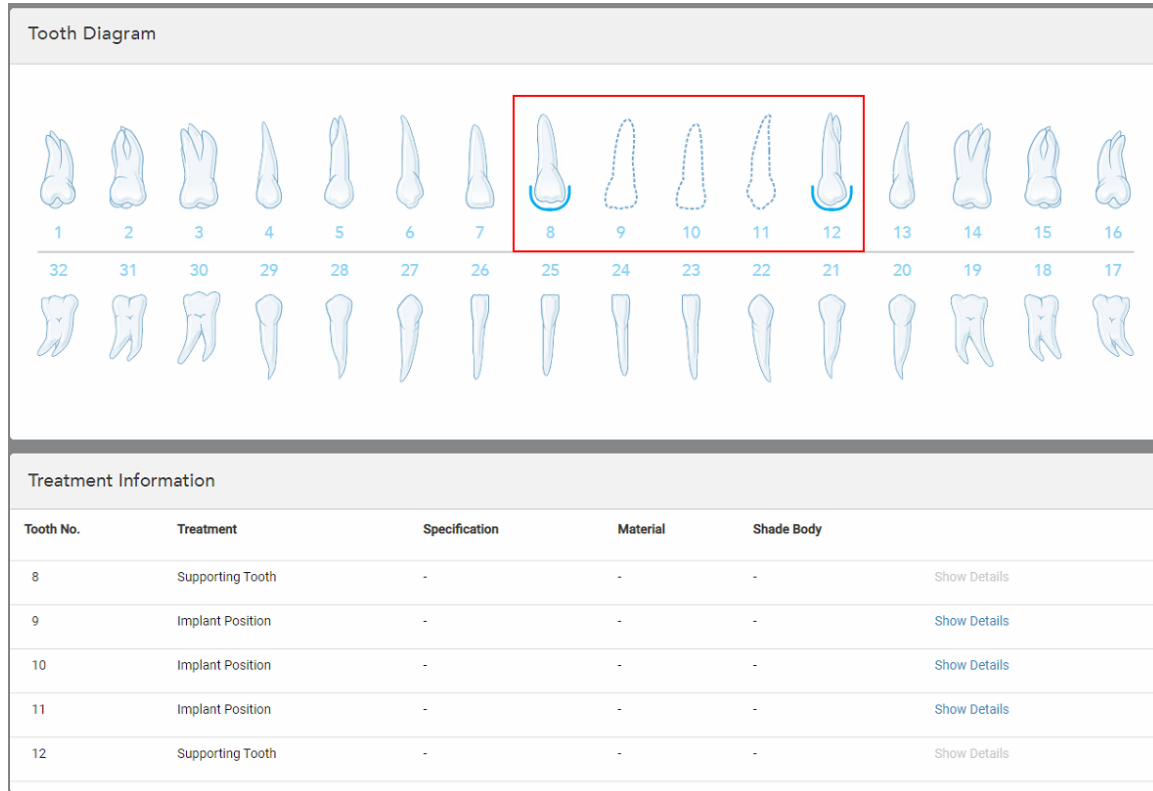

Figure 104: Implant Position window

- Select the implant manufacturer from the drop-down list. If required, you can save the implant manufacturers you use the most often as favorites, as described in [Saving list items as favorites](#).
- Tap  to save your changes and return to the *New Scan* window.

The teeth to be implanted and the supporting teeth, if relevant, are displayed in the **Tooth Diagram** area. Supporting teeth have a line under them and the teeth to be implanted are shown with a dotted line.

The details of each relevant tooth are displayed in the *Treatment Information* area below the **Tooth Diagram** area.



**Figure 105:** Supporting teeth and teeth to be implanted displayed in the Tooth Diagram and Treatment Information areas

10. In the **Attachments** area, turn on the toggle if you would like to upload videos, images, etc. from MyiTero, after sending the scan. In this case, the order will be on hold until it is sent via MyiTero.
11. In the **Notes** area, if required, enter any specific notes to the lab regarding the patient’s treatment. For example, special instructions for delivery or manufacturing. After entering your note, tap anywhere outside the **Notes** area to add the note. Each note shows the author of the note, with a timestamp, and can be edited and deleted.

### 5.3.5 Filling in the Rx for Denture/Removable procedures

The Denture/Removable procedure enables comprehensive planning and fabrication of partial and full dentures.

**Note:** Some fields are not mandatory before scanning the patient but must be filled in before you can send the scan.

**To fill in the Rx for a Denture/Removable procedure:**

1. In the **Patient** area, enter a patient’s details or search for an existing patient, as described in [Searching for existing patients](#).
2. In the **Order** area, select **Denture/Removable** from the **Procedure** drop-down list.

The *New Scan* window expands to display **Denture Details** and **Attachments** areas.

The screenshot shows the 'New Scan' window with the following sections:

- Doctor:** Dr. Demo, Demo | **License:** 12345
- Patient:**
  - First Name: \* Patient
  - Last Name: \* Demo
  - Date of Birth: \_\_\_\_\_
  - Gender:  Male  Female
  - Chart Number: \_\_\_\_\_
- Order:**
  - Procedure \* **Denture/Removable** | Type \* \_\_\_\_\_
  - Due Date: \_\_\_\_\_ | Send to: \_\_\_\_\_
- Denture Details:**
  - Stage: \_\_\_\_\_ | Shade System: **VITA Lumin**
  - Mould: \_\_\_\_\_ | Teeth Shade: \_\_\_\_\_
  - Upper Denture  | Lower Denture  | Gingival: \_\_\_\_\_
- Scan Options:**
  - New Sleeve Attached:
  - Denture Copy Scan:
- Attachments:**
  - Upload videos, images, X-rays and other external case-related files via MyiTero
  - I would like to upload files later via MyiTero
- Notes:**
  - Add Note

Figure 106: Denture/Removable procedure – Tooth Diagram and Attachment areas

- From the **Type** drop-down list, select the type of denture required. Depending on the type selected, the **Tooth Diagram** area is displayed.

The screenshot shows a software interface for configuring a denture procedure. The 'Order' section includes a 'Procedure' dropdown set to 'Denture/Removable' and a 'Due Date' field with a calendar icon. Below this is the 'Denture Details' section, which contains a 'Stage' dropdown, a 'Mould' dropdown, and two toggle switches for 'Upper Denture' and 'Lower Denture'. A 'Type' dropdown menu is open, showing five options: 'Partial Denture/Framework', 'Partial Immediate Denture', 'Full Immediate Denture', 'Full Denture Tissue Based', and 'Full Denture Implant Based'. Below the 'Type' menu are 'Teeth Shade' and 'Gingival' dropdown menus.

Figure 107: Denture/Removable procedure types

- If required, tap the calendar in the **Due Date** field and then select the date the denture is due from the lab.
- From the **Send To** drop-down list, select the lab to which the scan should be sent, your chairside milling software, or your MyiTero account.
- If required, in the **Denture Details** area, select the denture stage, mould, and shade system, including the teeth shade and the gingiva shade from the relevant drop-down lists.

**Upper/Lower Denture:** The relevant arch toggle turns on automatically according to the tooth indications in the **Tooth Diagram** area.

- In the **Scan Options** area, turn on/off the following toggles, as required.
  - New Sleeve Attached:** Turn on the **New Sleeve Attached** toggle to confirm that a new sleeve has been attached. For more information, see [Confirming a new sleeve between patients](#).

- **Denture Copy Scan:** Turn on the **Denture Copy Scan** toggle to include a scan of the existing dentures or temporary dentures. When you move to Scan mode, tap **1** to scan the existing dentures, and then tap **2** to scan the patient.

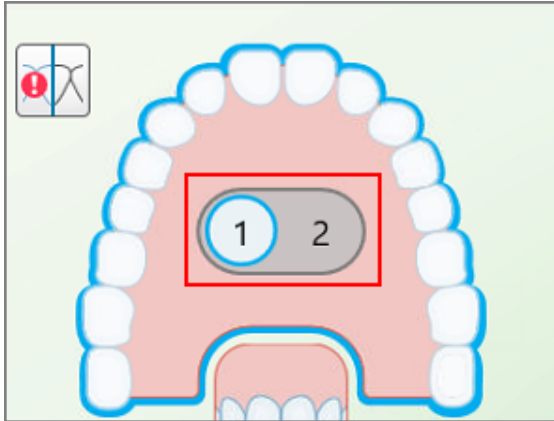

Figure 108: Scanning option for scanning both the existing dentures and the patient

8. In the **Tooth Diagram** area, define the teeth to be included in the denture according to the procedure type selected. This area is not relevant for Full Immediate Denture and Full Denture Tissue Based procedure types.

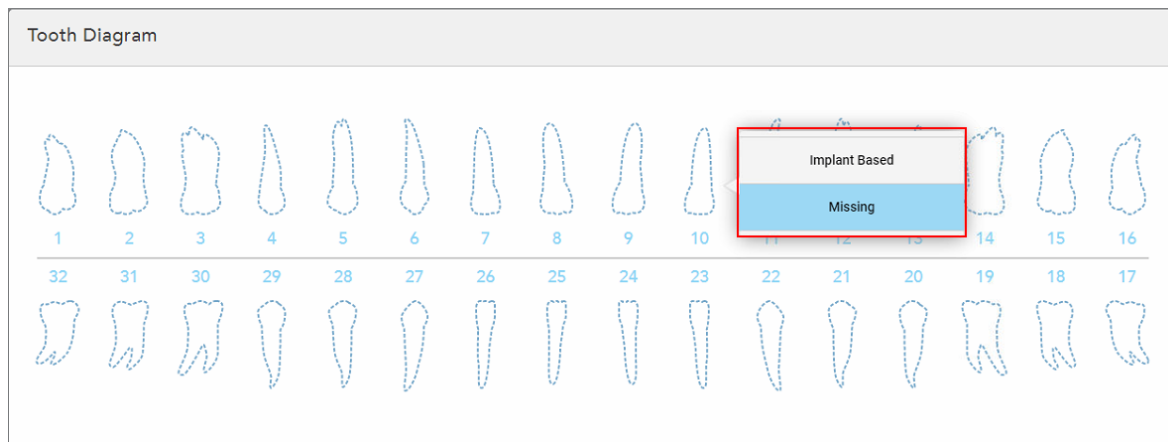

Figure 109: Defining the teeth to be included in the denture – Full Denture Implant Based procedure type

- Partial Denture/Framework – Tap each relevant tooth and select either **Clasp** or **Missing**.
- Partial Immediate Denture – Tap each relevant tooth and select either **Clasp** or **To Be Removed**.

- Full Denture Implant Based – Tap each relevant tooth and select either **Implant Based** or **Missing**. If you select **Implant Based**, the *Implant Based* settings window is displayed, with all fields mandatory.

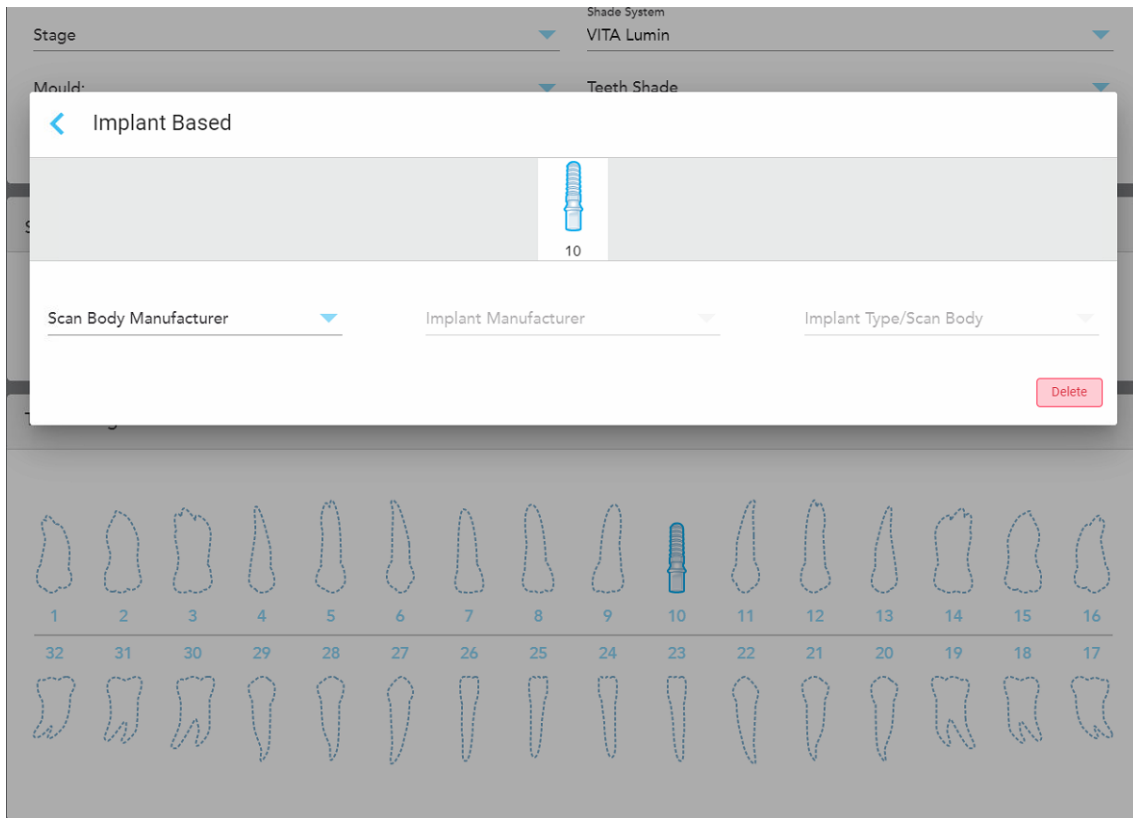



Figure 110: Implant Based settings window

- For each Implant-based tooth, select the scan body manufacturer, the implant manufacturer, and the implant type/scan body from the relevant drop-down lists. If required, you can save the scan body and implant manufacturers you use the most often as favorites, as described in [Saving list items as favorites](#).
  - Tap  to save your changes and return to the *New Scan* window.
- The **Treatment Information** area displays all indications for each tooth. If required, edit the details for each tooth by tapping **Show Details**.
  - In the **Attachments** area, turn on the toggle if you would like to upload videos, images, etc. from MyiTero, after sending the scan. In this case, the order will be on hold until it is sent via MyiTero.
  - In the **Notes** area, if required, enter any specific notes to the lab regarding the patient's treatment. For example, special instructions for delivery or manufacturing. After entering your note, tap anywhere outside the **Notes** area to add the note. Each note shows the author of the note, with a timestamp, and can be edited and deleted.

12. Tap  on the toolbar to move to Scan mode, as described in [Scanning the patient](#).

**Note:** Excess soft tissue will not be removed automatically from around the edges of the model during scanning. If required, you can enable automatic cleanup by pressing on the screen and then tapping the Auto Cleanup tool. For more information, see [Disabling auto-cleanup](#).

### 5.3.6 Filling in the Rx for Appliance procedures

The Appliance procedure enables you to create a prescription for various dental appliances, such as night guards and sleep appliances.

#### To fill in the Rx for an Appliance procedure:

1. In the **Patient** area, enter a patient's details or search for an existing patient, as described in [Searching for existing patients](#).
2. In the **Order** area, select **Appliance** from the **Procedure** drop-down list.
3. From the **Type** drop-down list, select the type of appliance required. If the required appliance is not listed, select **Ortho Appliance** and then enter your requirements in the **Notes** area at the bottom of the window.

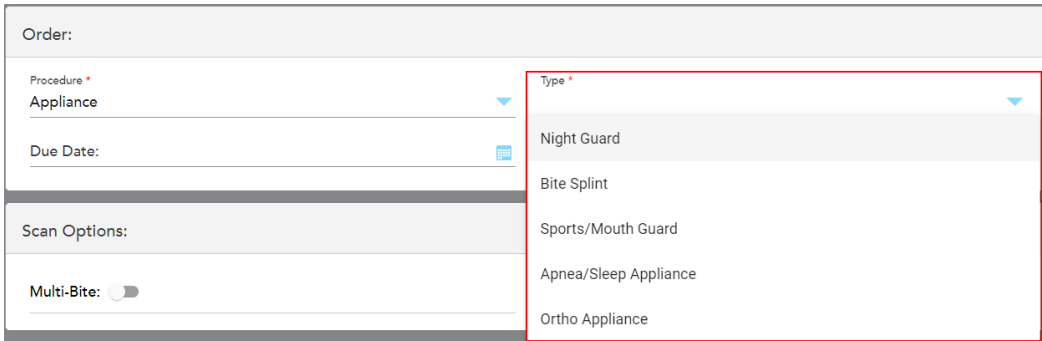

The screenshot shows a form titled "Order:" with a "Procedure" dropdown menu set to "Appliance". Below it is a "Due Date" field. A "Scan Options" section contains a "Multi-Bite" toggle switch. A "Type" dropdown menu is open, showing a list of appliance types: Night Guard, Bite Splint, Sports/Mouth Guard, Apnea/Sleep Appliance, and Ortho Appliance. The "Type" dropdown is highlighted with a red border.

Figure 111: Appliance procedure types

4. Continue filling in the prescription from step 4, **Due Date**, as described in [Filling in the Rx](#).

### 5.3.7 Saving list items as favorites

If required, you can select the materials, scan body manufacturers, and implant manufacturers you use the most often and save them as favorites, which are pinned to the top of each relevant list.

#### To save a list item as a favorite:

1. In the relevant Material, Scan Body Manufacturer, or Implant Manufacturer list, tap **Add favorites** and then select one or more items in the list.

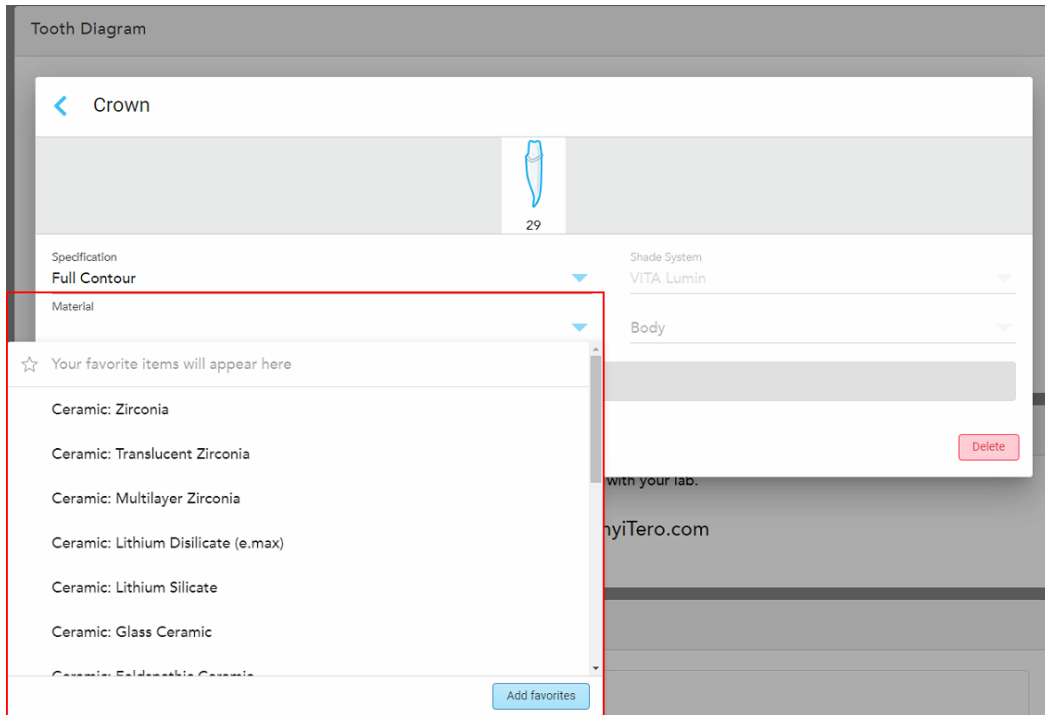

Figure 112: Adding a favorite material

2. Tap **Done**.

The selected items are displayed with a star at the top of the list and are easily visible when filling out the Rx.

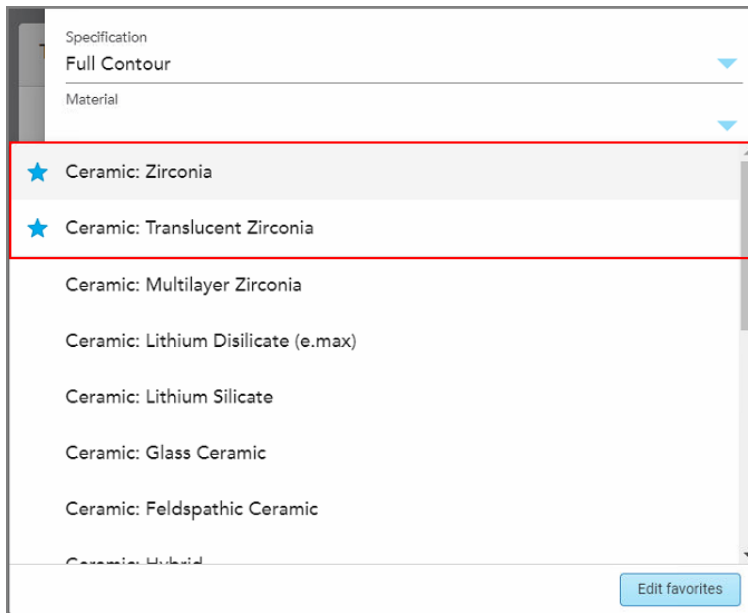



Figure 113: Favorite materials pinned to the top of the Material list

3. To remove a favorite or add additional favorites, tap **Edit favorites**.

### 5.3.8 Confirming a new sleeve between patients

In order to reduce the risk of cross-contamination, you must replace the sleeve for each patient.

You are required to confirm the new sleeve using one of the following options:

- Activating the **New Sleeve Attached** option when filling in a new Rx, as described in [Confirming the new sleeve when filling in the Rx](#). This method is minimally intrusive and will not alarm the patient.
- Pressing either of the wand buttons or tapping **OK** when prompted, when trying to access Scan mode , as described in [Confirming the new sleeve when accessing Scan mode](#).

Failure to confirm a new sleeve will block you from starting a new scan.

Both methods of sleeve confirmation are documented in the log file, which contains the name of the user who confirmed the new sleeve, as well as the timestamp.

#### 5.3.8.1 Confirming the new sleeve when filling in the Rx

In the *New Scan* window, turn on the **New Sleeve Attached** toggle to confirm that a new sleeve is attached to the wand.

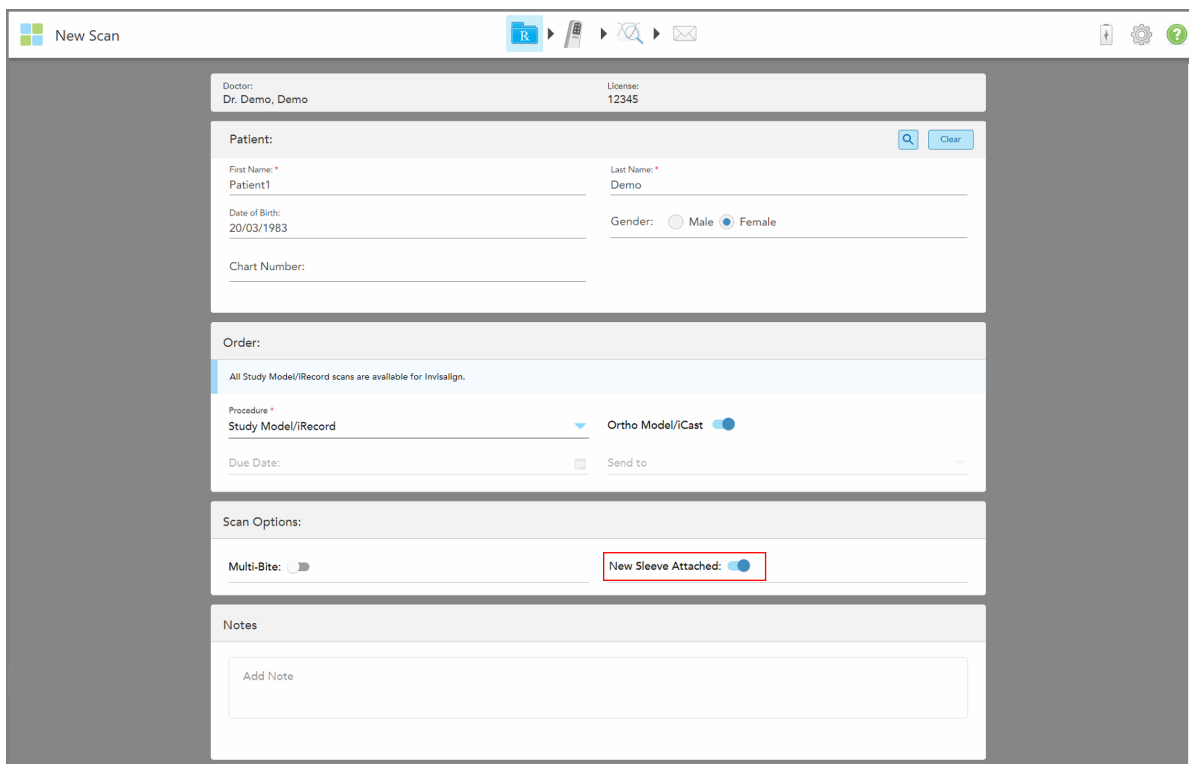

The screenshot shows the 'New Scan' window with the following fields and options:

- Doctor:** Dr. Demo, Demo
- License:** 12345
- Patient:**
  - First Name: \* Patient1
  - Last Name: \* Demo
  - Date of Birth: 20/03/1983
  - Gender:  Male  Female
  - Chart Number:
- Order:**
  - All Study Model/Record scans are available for Invisalign.
  - Procedure: \* Study Model/Record
  - Ortho Model/iCast:
  - Due Date:
  - Send to:
- Scan Options:**
  - Multi-Bite:
  - New Sleeve Attached:**  (highlighted with a red box)
- Notes:**
  - Add Note

Figure 114: Confirming that a new sleeve is attached

- If the **New Sleeve Attached** toggle is turned on, you will not see any further messages and are able to scan upon entry to Scan mode.
- If the **New Sleeve Attached** toggle is not turned on, you will be blocked from accessing Scan mode and will have to confirm the new sleeve, as described in the following section.

### 5.3.8.2 Confirming the new sleeve when accessing Scan mode

If you did not turn on the **New Sleeve Attached** toggle when filling in the new Rx, the following message is displayed when tapping the Scan tool :

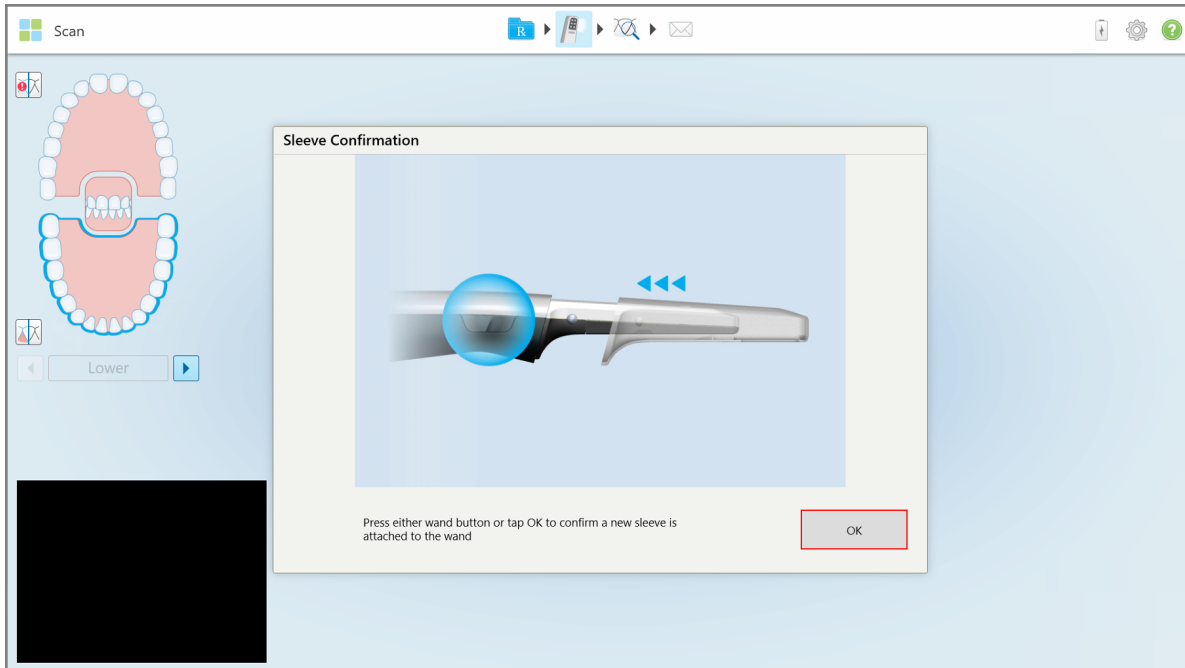

Figure 115: Popup confirmation message before scanning

You are blocked from scanning until you tap **OK** on the screen or press either of the wand buttons.

## 5.4 Patient management

You control the patient's data-management process from the **Patient** area in the *New Scan* window.

You can:

- [Add a new patient](#)
- [Search for an existing patient](#)
- [Edit a patient's details](#)
- [Clear the patient details from the \*New Scan\* window](#)

### 5.4.1 Adding new patients

You can add a new patient while filling in the Rx. The patient's details will be saved once you move to the *Scan* window and can later be edited, as described in [Editing the patient details](#).

In addition, you can add new patients using MyiTero or your Dental Program Management Services (DPMS) software.

#### To add a new patient:

1. In the *New Scan* window, in the **Patient** area, enter the patient's first name and last name.
2. If required, enter the patient's date of birth, select the patient's gender, and enter a unique identifier as the patient's chart number.

**Note:** By default, the date is written in DD/MM/YYYY format. If required, you can change the date format, as described in [Defining the localization settings](#).

The new patient's details are displayed in the **Patient** area of the *New Scan* window.

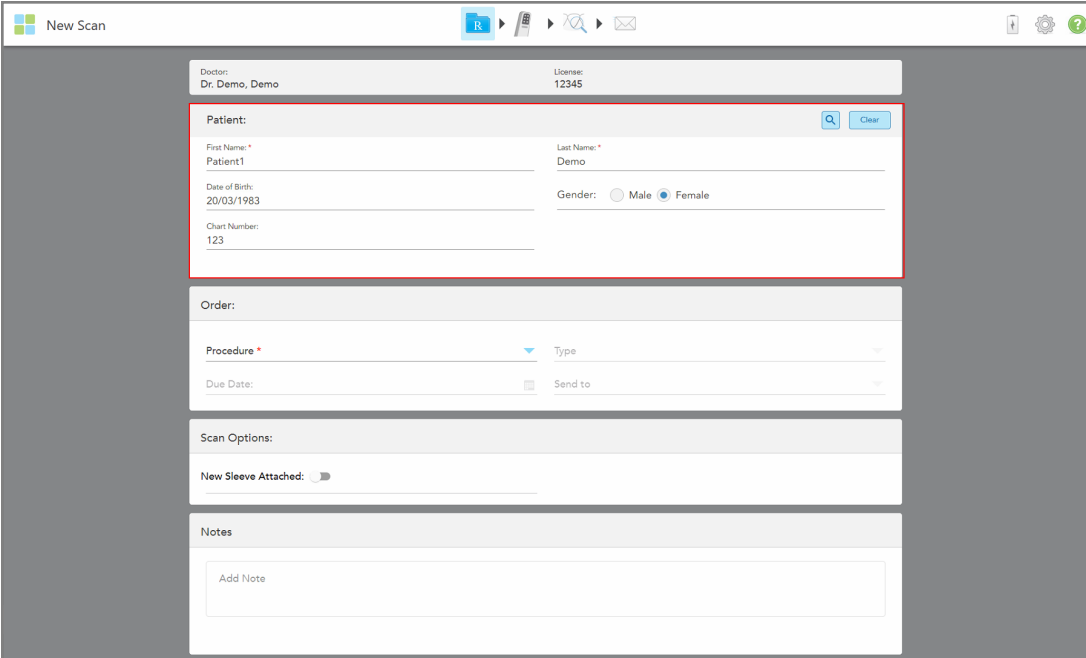

The screenshot shows the 'New Scan' window with a patient details form highlighted by a red border. The form contains the following fields:

- Doctor: Dr. Demo, Demo
- License: 12345
- Patient: (Search and Clear buttons)
- First Name: Patient1
- Last Name: Demo
- Date of Birth: 20/03/1983
- Gender:  Male  Female
- Chart Number: 123

Below the patient details, there are sections for Order, Scan Options, and Notes.

- Order: Procedure (dropdown), Type (dropdown), Due Date (calendar), Send to (dropdown)
- Scan Options: New Sleeve Attached (toggle)
- Notes: Add Note (text area)

Figure 116: Adding a new patient

**Note:** If you try adding a patient who already exists, the **First Name**, **Last Name**, and **Chart Number** fields are highlighted, and a message is displayed notifying you that a patient with the same details already exists.

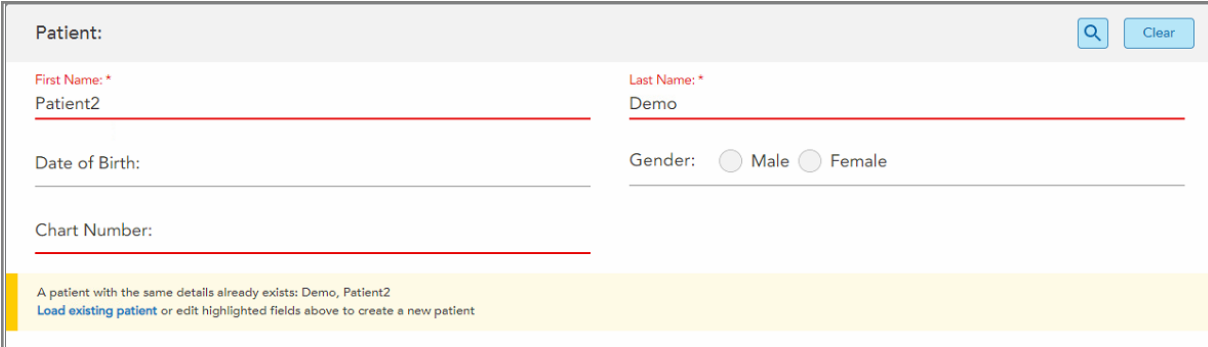

Patient: 🔍 Clear

First Name: \* Patient2 Last Name: \* Demo

Date of Birth: Gender:  Male  Female

Chart Number:

A patient with the same details already exists: Demo, Patient2  
[Load existing patient](#) or edit highlighted fields above to create a new patient

Figure 117: Message notifying that a patient with the same details exists

- If the new patient and the existing patient are the same person, tap **Load existing patient**.
- If the new patient and the existing patient are different people, edit the highlighted fields – First Name, Last Name, or Chart Number – to create a new patient.

The patient's details are displayed in the *New Scan* window.

#### 5.4.2 Searching for existing patients

When searching for an existing patient, you must enter at least 3 characters of the patient's name in the search field to see a list of patients who match the search criteria.

In addition, you can search for a patient from the **Patients** page, described in [Searching for patients](#).

**To search for an existing patient:**

- In the *New Scan* window, in the **Patient** area, tap .

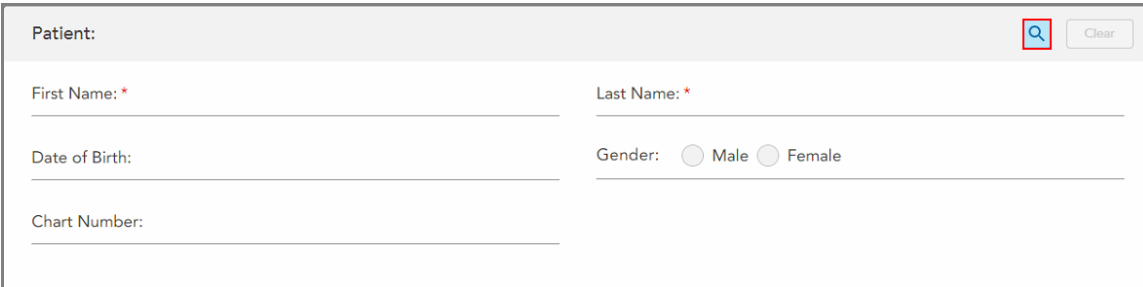

Patient: 🔍 Clear

First Name: \* Last Name: \*

Date of Birth: Gender:  Male  Female

Chart Number:

Figure 118: Patient area of the New Scan window – searching for an existing patient

The *Search Patient* window is displayed.

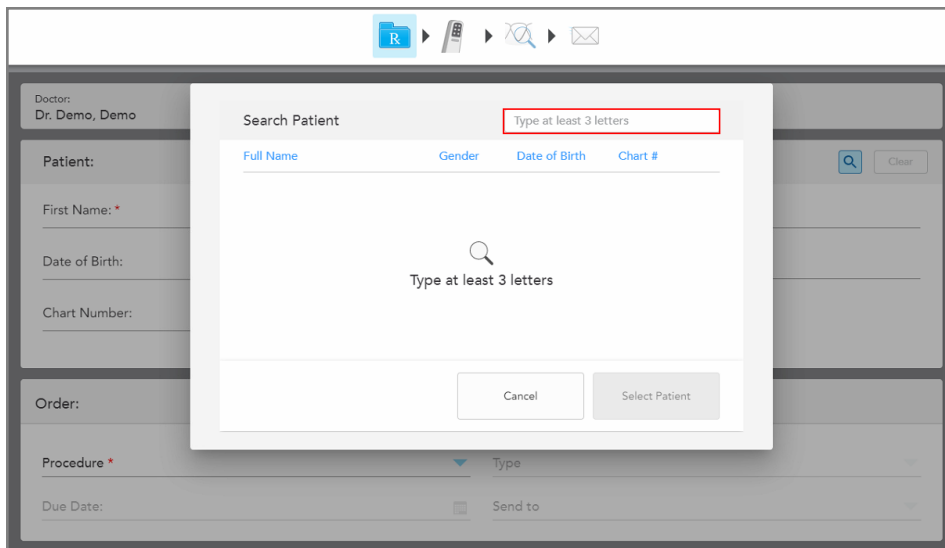

Figure 119: Search Patient window with a search field

- In the *Search Patient* window, enter at least three letters in the search field to display a list of patients matching the search criteria.

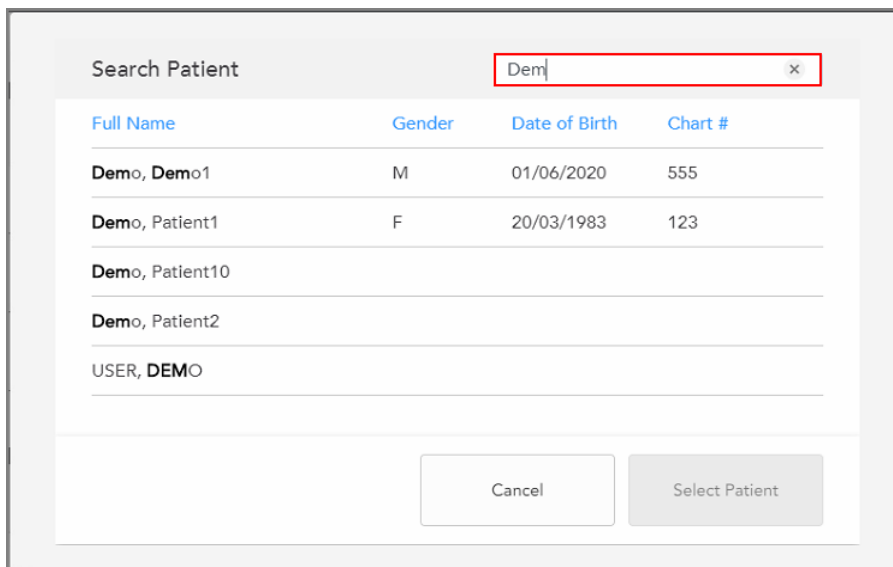

Figure 120: Search criteria in the search field and list of matching patients

3. Select the required patient, and then tap **Select Patient**.

Full Name	Gender	Date of Birth	Chart #
Dem, Demo1	M	01/06/2020	555
Dem, Patient1	F	20/03/1983	123
Dem, Patient10			
Dem, Patient2			
USER, DEMO			

Figure 121: Selecting the required patient

The selected patient is displayed in the **Patient** area of the *New Scan* window.

Figure 122: Selected patient displayed in the Patient area of the New Scan window

### 5.4.3 Editing the patient details

After you have searched for and selected a patient, or after you have added a new patient, you can edit the patient's details.

In addition, you can edit the patient's details when opening the Rx from the patient's profile page, as described in [Viewing the Rx](#).

**To edit a patient's details:**

1. Search for an existing patient, as described in [Searching for existing patients](#).  
The patient is displayed in the *New Scan* window.

2. In the **Patient** area, tap .

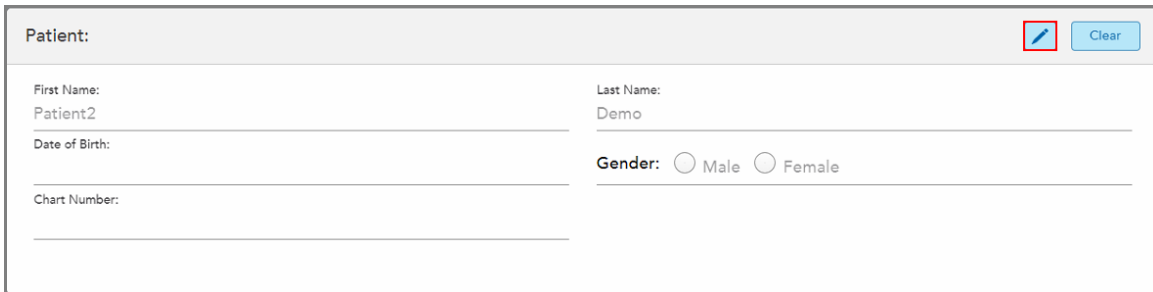

**Patient:** 

First Name: Patient2  
Last Name: Demo

Date of Birth: \_\_\_\_\_  
Gender:  Male  Female

Chart Number: \_\_\_\_\_

Figure 123: Patient area of New Scan window – editing a patient

The *Edit Patient* window is displayed.

3. Edit the patient's details as required and then tap **Update**.

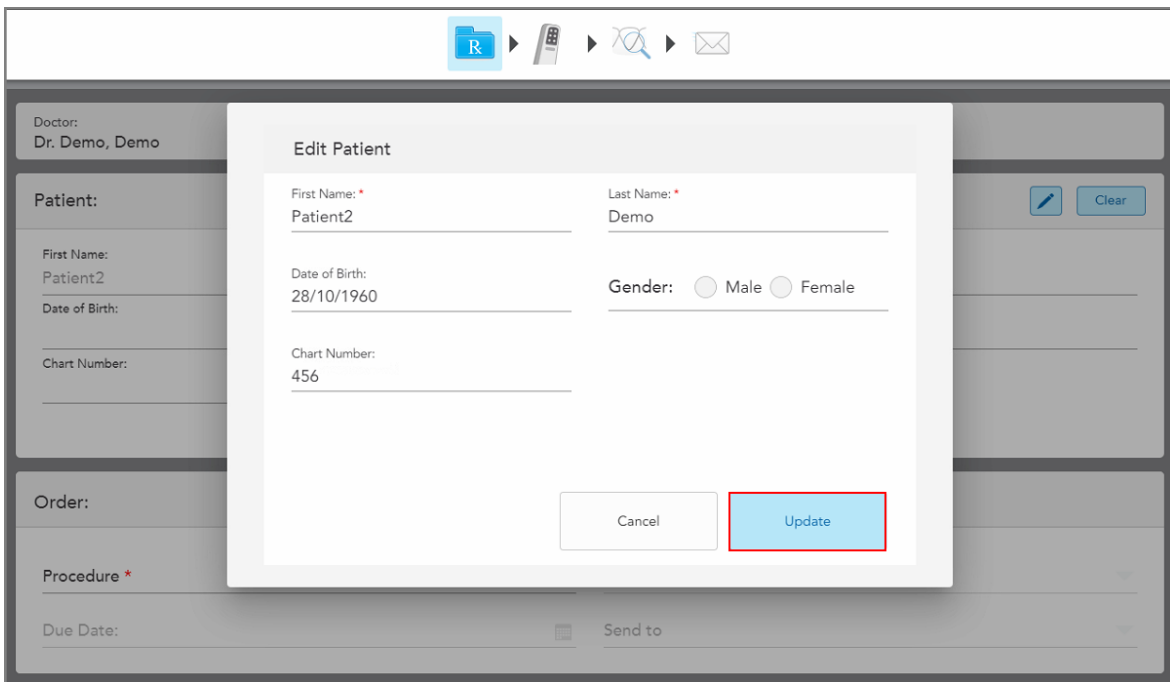

**Edit Patient**

First Name: \* Patient2  
Last Name: \* Demo

Date of Birth: 28/10/1960  
Gender:  Male  Female

Chart Number: 456

Figure 124: Edit Patient window and Update button

If, while editing the patient's name, you enter the same details as an existing patient, a message is displayed notifying you of such.

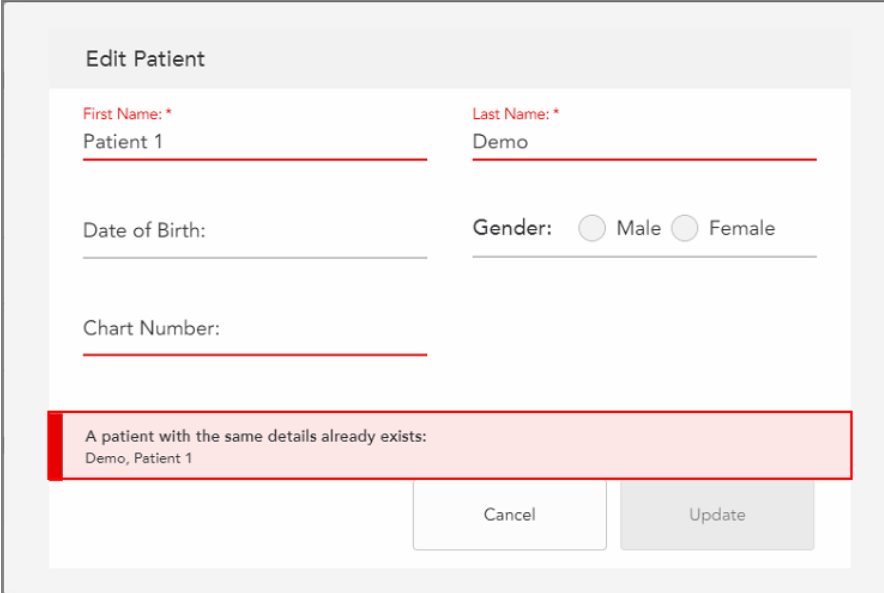

The screenshot shows the 'Edit Patient' form with the following fields: First Name (Patient 1), Last Name (Demo), Date of Birth, Gender (Male/Female), and Chart Number. A red message box at the bottom states: 'A patient with the same details already exists: Demo, Patient 1'. The 'Update' button is disabled.

Figure 125: Message that a patient with the same details already exists

To differentiate between patients with the same details, enter a unique identifier in the **Chart Number** field.

#### 5.4.4 Clearing the patient details from the New Scan window

If required, you can remove the currently-displayed patient's details from the *New Scan* window.

**To clear the patient details from the New Scan window:**

1. In the **Patient** area, tap .

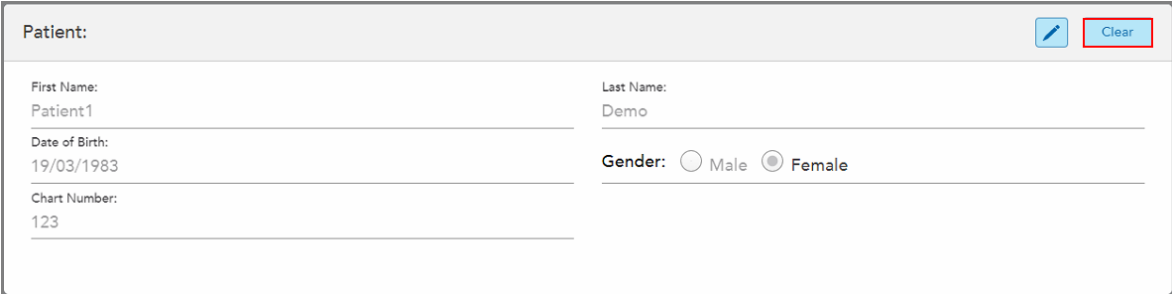

The screenshot shows the 'Patient' form with the following fields: First Name (Patient1), Last Name (Demo), Date of Birth (19/03/1983), Gender (Male/Female), and Chart Number (123). A blue 'Clear' button is highlighted in the top right corner.

Figure 126: Clear patient details button

A confirmation message is displayed.

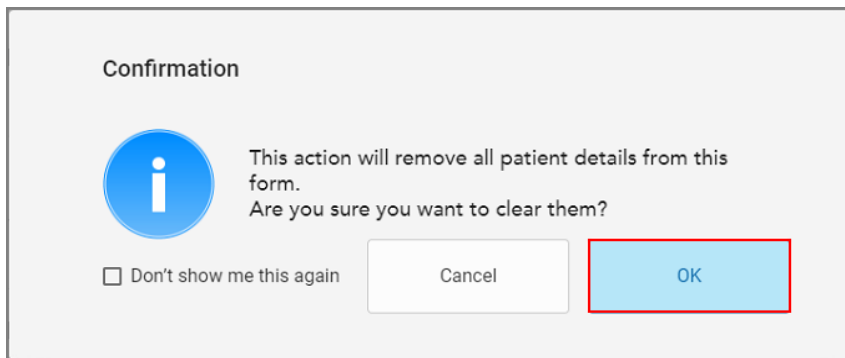



Figure 127: Clear confirmation message

2. Tap **OK** to clear the patient's details.

If required, you can select the **Don't show me this again** check box. In the future, the patient details will be cleared from the *New Scan* window as soon as you tap the **Clear** button.

All data is cleared from the *New Scan* window, and you can now add a new patient or search for an existing patient, if required.

## 5.5 Scanning the patient

After you have filled in the Rx, tap  on the toolbar to enter Scan mode. The *Scan* window is displayed, enabling you to start scanning the patient.

**Note:** After switching on the scanner, the system requires approximately 7 minutes to initialize and warm up. If the wand is not ready for use,  is displayed on the scanner toolbar and a progress bar displays the status of the initialization.

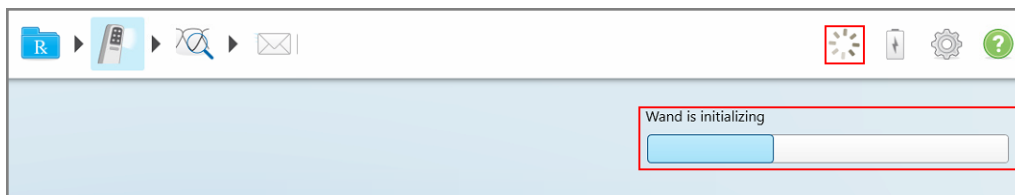

Figure 128: Wand initialization icon and progress bar

Ensure that the patient's mouth is dry both before and during the scan.

While in Scan mode, you can perform the following actions:

- View additional scan feedback, described in [Additional scan feedback](#)
- Toggle between color and monochrome mode, described in [Toggling the scan color](#)

You can also edit the scan, as follows:

- Delete a segment, as described in [Deleting a segment](#)
- Trim away excess soft tissue, as described in [Working with the Trim tool](#)

- Erase selected areas of the scanned model, as described in [Working with the Eraser tool](#)
- Display the excess tissue around the edges of the 3D model, as described in [Disabling auto-cleanup](#)

When you have finished scanning the patient, tap  on the toolbar to move to **View** mode, where you can review the scan.

### 5.5.1 Scanning guidance

As soon as you move to Scan mode, the recommended scanning sequence for the selected scan segment is displayed, by default, in the center of the scanner window. It will automatically disappear after a short while, or you can tap anywhere on the screen to hide it.

If required, you can disable the scanning guidance for all scans, as described in [Defining the scan settings](#).

iTerio Lumina supports sequence-free scanning, which means that you do not have to scan according to a set protocol. For more information on working with unstitched scanned segments, see [Working with unstitched scanned segments](#).

iTerio recommends you follow the displayed scanning sequence for best results.

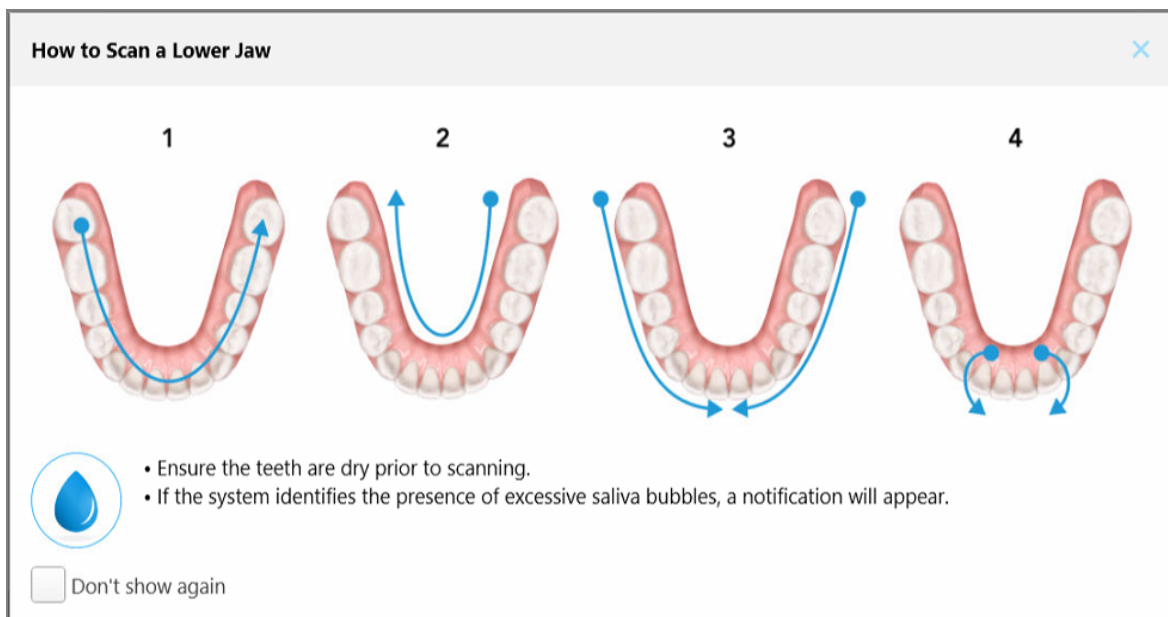

Figure 129: Recommended scanning sequence – lower jaw

**Note:** If you select the **Do not show again** check box, this guidance will not be displayed in future scans. You can return the guidance by enabling it in the **Scan** settings, as described in [Defining the scan settings](#).

Firmly press either of the wand buttons to begin scanning. The wand emits a sound, indicating that scanning has started.

To allow optimal capturing of 3D images, the wand should be held 4mm above the patient's teeth.

### 5.5.1.1 Saliva detection

By default, saliva detection during scanning is disabled. If required, you can enable saliva detection for the current scan by pressing on the screen and then tapping **Enable Saliva Detection**, as described in [Enabling saliva detection](#). You can also enable saliva detection, by default, for all scans, as described in [Defining the scan settings](#).

If saliva detection is enabled, when saliva bubbles are detected by the system during the scan, a saliva drop icon appears at the bottom of the screen indicating saliva detection. The area on the 3D model where the saliva was detected is removed, such that a hole is formed on the model's surface.

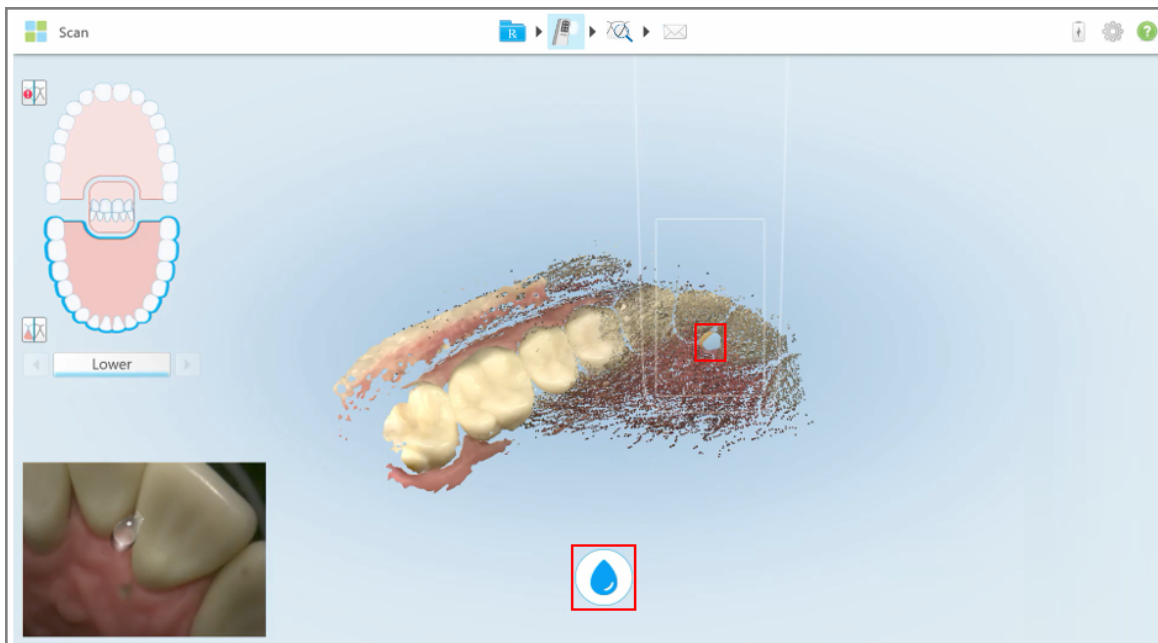

Figure 130: Saliva detection – area with saliva bubbles is shown as a hole and a drop icon is displayed

All areas with saliva bubbles need to be dried and rescanned before sending the scan. The drop icon reappears when hovering over the area, if the saliva still exists.

When pausing the scan, the area with saliva bubbles is displayed in light blue.



Figure 131: Saliva detection – area with saliva bubbles is displayed in light blue when scanning is paused

## 5.5.2 Scanning best practices

Before scanning the patient, read and understand the [Safety instructions](#).

iTero recommends the following best practices for use of the scanner and accessories:

- Ensure that the sleeves remain in the labeled box or in the sleeve basket on the cart-configuration scanner, until the time of use.
- Before applying the sleeve, inspect it for any visible discoloration, damage, or distortion that may prevent proper application. Ensure that the clear window is not scratched. After scanning, inspect the clear window to make sure it is not cracked. If damage is observed, see the **iTero Lumina sleeves** section of the [Safety instructions](#).
- If the patient bites down on the sleeve, stop the procedure and inspect the sleeve for visible damage.
  - If damage is observed, remove the sleeve and visually inspect the optical tip of the wand.
    - If cracks are observed on either the optical surface or the tip of the wand, do not use the wand, contact iTero Support, and see the **Scanner warnings** section of the [Safety instructions](#).
  - If no damage to the wand is observed, replace the sleeve and continue the scan.

iTero recommends the following best practices for scanning fixed restorative procedures:

- Ensure that the prepped tooth and the surrounding area are free of debris, saliva, and blood contamination.
- The prepped tooth should be dry, and the margin line should be clear of tissue.
- You should be familiar with proper scanning techniques and avoid over scanning.

## 5.5.3 Scan options

In Scan mode, you can select the following options:

- Additional scan feedback, described in [Additional scan feedback](#)
- Toggle color/monochrome, described in [Toggling the scan color](#)
- Switch to the next scan segment, described in [Switching to the next scan segment](#)
- Switch to an unstitched scanned segment, described in [Working with unstitched scanned segments](#)
- Delete unstitched segments, described in [Working with unstitched scanned segments](#)
- Edit the scan:
  - Delete a segment, described in [Deleting a segment](#)
  - Trim away excess tissue, described in [Working with the Trim tool](#)
  - Erase a selected area of the scanned model, described in [Working with the Eraser tool](#)
  - Disable auto-cleanup, described in [Disabling auto-cleanup](#)
  - Enable saliva detection, described in [Enabling saliva detection](#)

### 5.5.3.1 Additional scan feedback

You can activate the additional scan feedback mode  to alert you to the areas that need additional scanning, to ensure that critical areas that could compromise the whole model are not missed.

Areas with missing anatomy are highlighted in red when scanning in monochromatic mode, and purple when scanning in color mode.

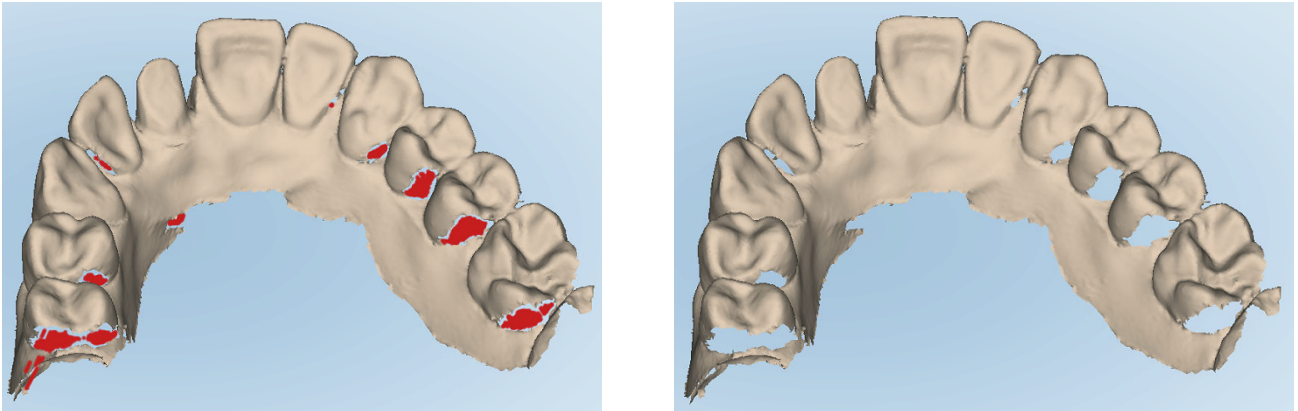

Figure 132: Areas with missing anatomy shown with and without additional scan feedback – monochrome

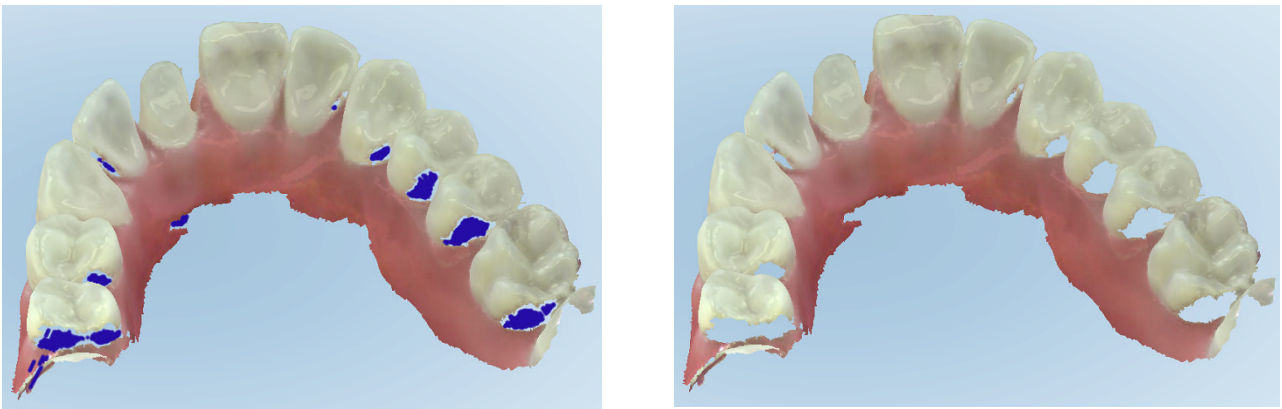



Figure 133: Areas with missing anatomy shown with and without additional scan feedback – color mode

By default, this mode is enabled, but it can be disabled per case by tapping  or by default in the Scan settings, as described in [Defining the scan settings](#).

### 5.5.3.2 Toggling the scan color



The color toggle button  allows you to toggle between color and monochromatic modes. This applies to both scanning and viewing all procedures.

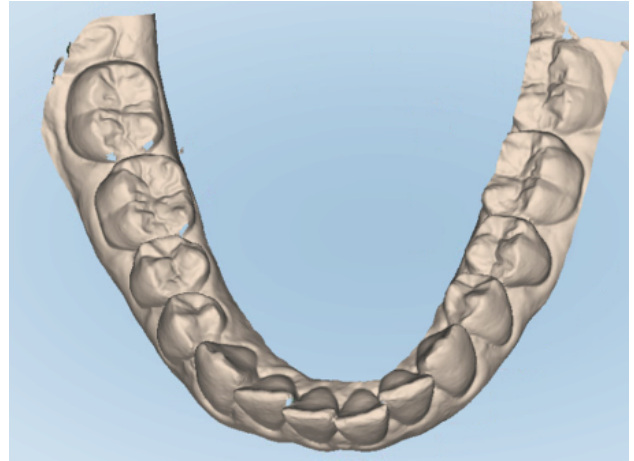
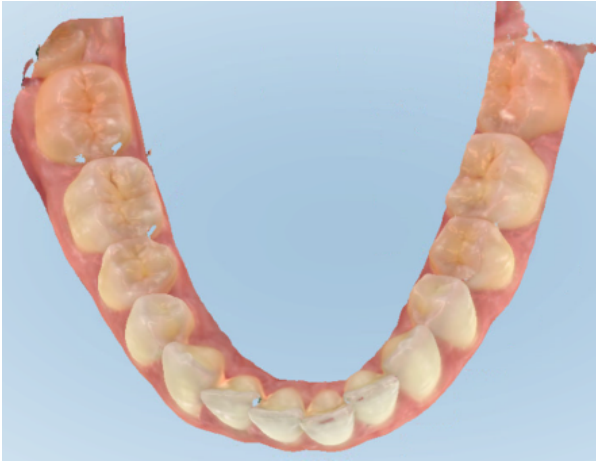



Figure 134: Model displayed in color and monochrome mode

By default, models are scanned in color, but you can toggle the display per case by tapping  or by default in the Scan settings, as described in [Defining the scan settings](#).

### 5.5.3.3 Switching to the next scan segment

During scanning, the current segment is highlighted in blue in the navigation controls, and also displayed in the segment indicator box, between the arrows.

**Note:** Before moving to the next segment, press either of the wand side buttons to stop the wand from scanning. The system emits a sound when stopping the scan and again when restarting the scan.

You can move to the next segment by:

- Tapping on the relevant arch, prepped tooth, or bite segment
- Tapping the arrows

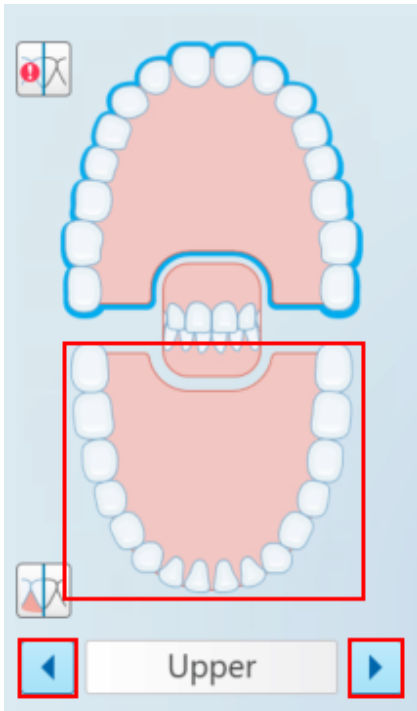

Figure 135: Tap the opposite arch or tap the arrows to select it

#### 5.5.3.4 Working with unstitched scanned segments

iTero Lumina supports sequence-free scanning, which means that you do not have to scan your patient according to a set protocol.

While scanning, any unstitched segments of the 3D model are saved on the side of the *Scan* window. The latest segment is displayed in full color, but the older segments appear faded. You can see up to 4 segments without pausing the scan to view any additional detected segments.

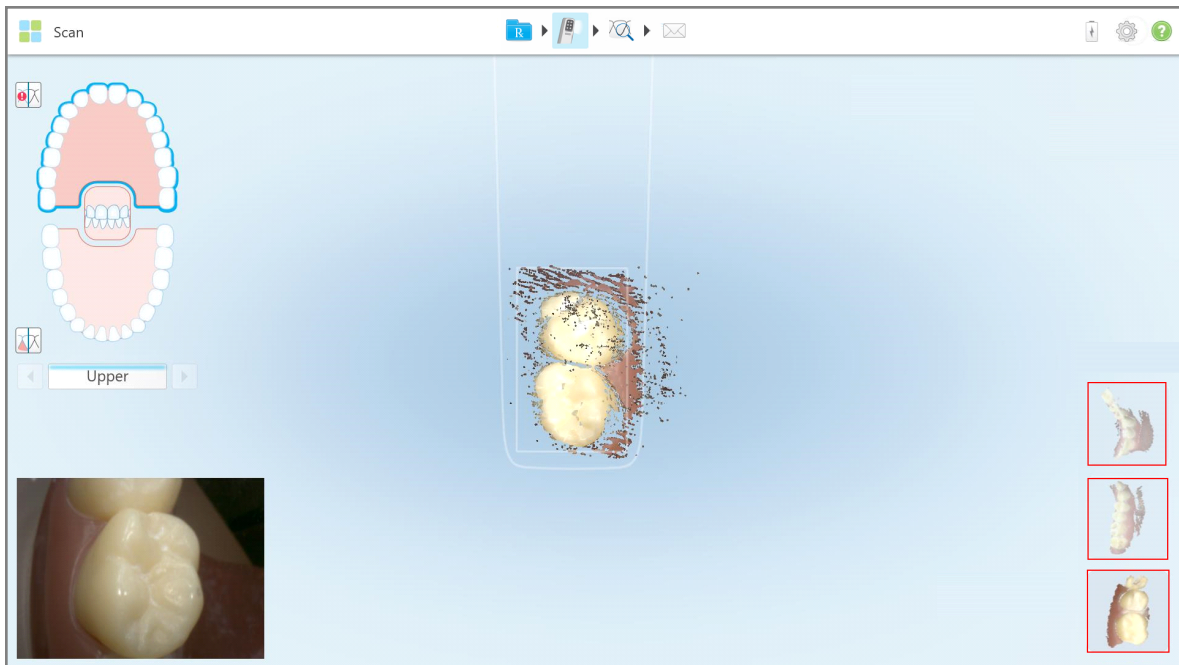

Figure 136: Unstitched scanned segments displayed on the right of the Scan window.

When you scan the overlapping area between the 3D model and an unstitched segment, the system stitches them together in the *Scan* window and removes the segment from the side of the window.

If required, you can double-tap an unstitched segment to display it in the center of the window instead of the 3D model of the scan. You can also press the segment and then tap **Switch to main segment**.

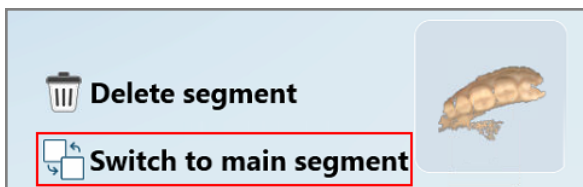

Figure 137: Switching to the main segment

You can delete an unstitched segment by pressing it and then tapping **Delete segment**.

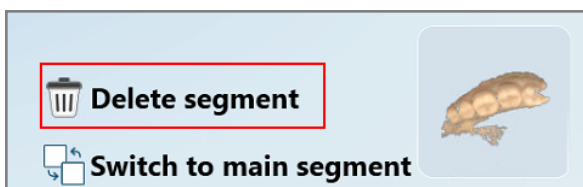

Figure 138: Deleting an unstitched segment

By default, sequence-free scanning is enabled, but you can disable it from the **Scan** settings, as described in [Defining the scan settings](#).

### 5.5.4 Editing a scan

After you have scanned the model, you can edit it using the following tools:

- Delete Segment tool, described in [Deleting a segment](#)
- Trim tool, described in [Working with the Trim tool](#)
- Eraser tool, described in [Working with the Eraser tool](#)
- Disable auto-cleanup tool, described in [Disabling auto-cleanup](#)
- Enable Saliva Detection tool, described in [Enabling saliva detection](#)

The editing tools are accessed by pressing on the screen.

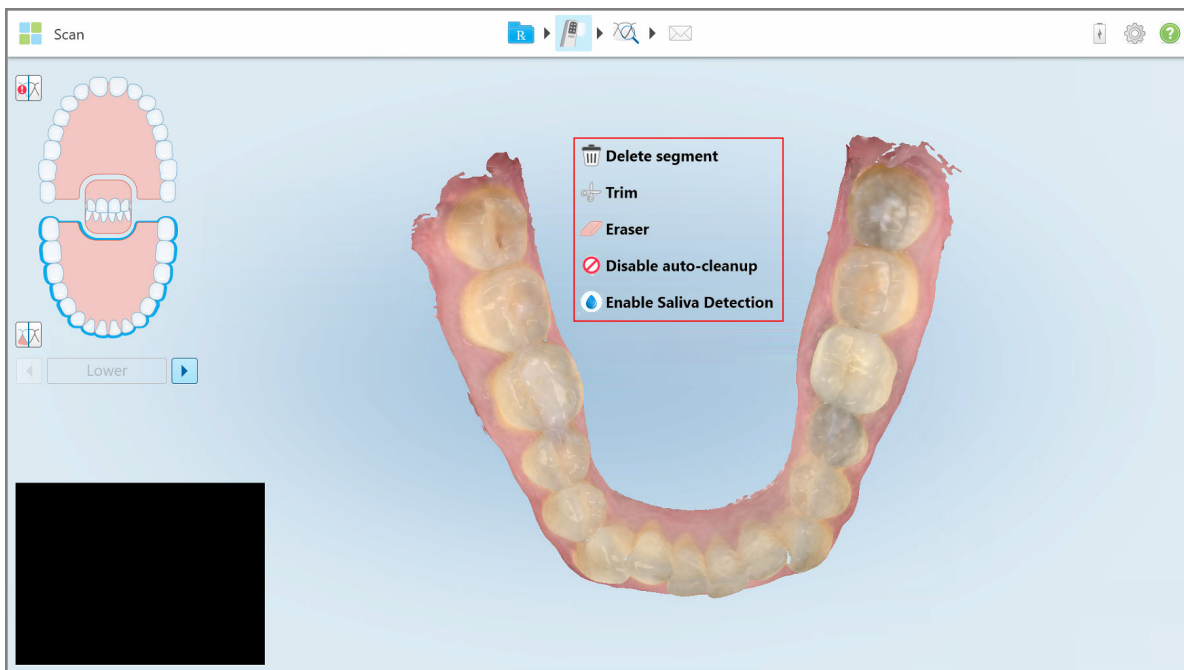



Figure 139: Editing tools

## 5.6 Viewing the scan

After scanning the patient, tap  to move to View mode. After the post-processing stage is complete, you can inspect the model in high resolution to ensure that sufficient anatomy has been captured, and that the model is accurate and complete.

If there are missing scan segments or missing bites, a message will be displayed at the beginning of the post-processing stage notifying you of this and enabling you to go back and add the missing areas of the scan. For more information, see [Missing scan segment notifications](#).

While viewing the scan, you can:

- Trim excess tissue from the scan, as described in [Working with the Trim tool](#).
- Manually create the die separation if the green hint point was not on the center of the prepped tooth during scanning, as described in [Working with the Die Separation tool](#).
- Define the margin line, as described in [Working with the Margin Line tool](#).
- View an area of interest using the Review tool, as described in [Working with the Review tool](#).
- Capture a screenshot of the model, as described in [Working with the Snapshot tool](#).



After you have reviewed the scan to ensure that it is complete, tap  on the toolbar to send the scan to the lab, your chairside milling software, or your MyiTerio account, as described in [Sending the scan](#).

**Note for Fixed Restorative and Denture/Removable procedures:** After viewing the scan, return to the *New Scan* window to fill in any mandatory fields that were not filled in. These fields were not mandatory when scanning the patient but must be filled in before sending the scan. If there are missing fields when sending the scan, a message is displayed, prompting you to fill in all mandatory fields highlighted in red in the **Treatment Information** area.

### 5.6.1 Missing scan segment notifications



If there are missing scan segments or bite scans when you tap the  button, you will be notified at the beginning of the post-processing stage, and you will be able to go back and add the missing areas of the scan, in order to reduce manual intervention later on.

Notifications are displayed in the following cases:

- Missing prep or arch – segments were not scanned or not stitched together properly
- Bite issues
- Missing bite
- Bite scanned from one side only
- Discrepancy between the left and the right bite scans

In addition, the bite section in the navigation controls is highlighted in red.

The message may be generic, or very specific to the issue including guidance on how to correct the issue. In some cases, you may be warned that the scan may be returned from the lab if you do not fix the issues.

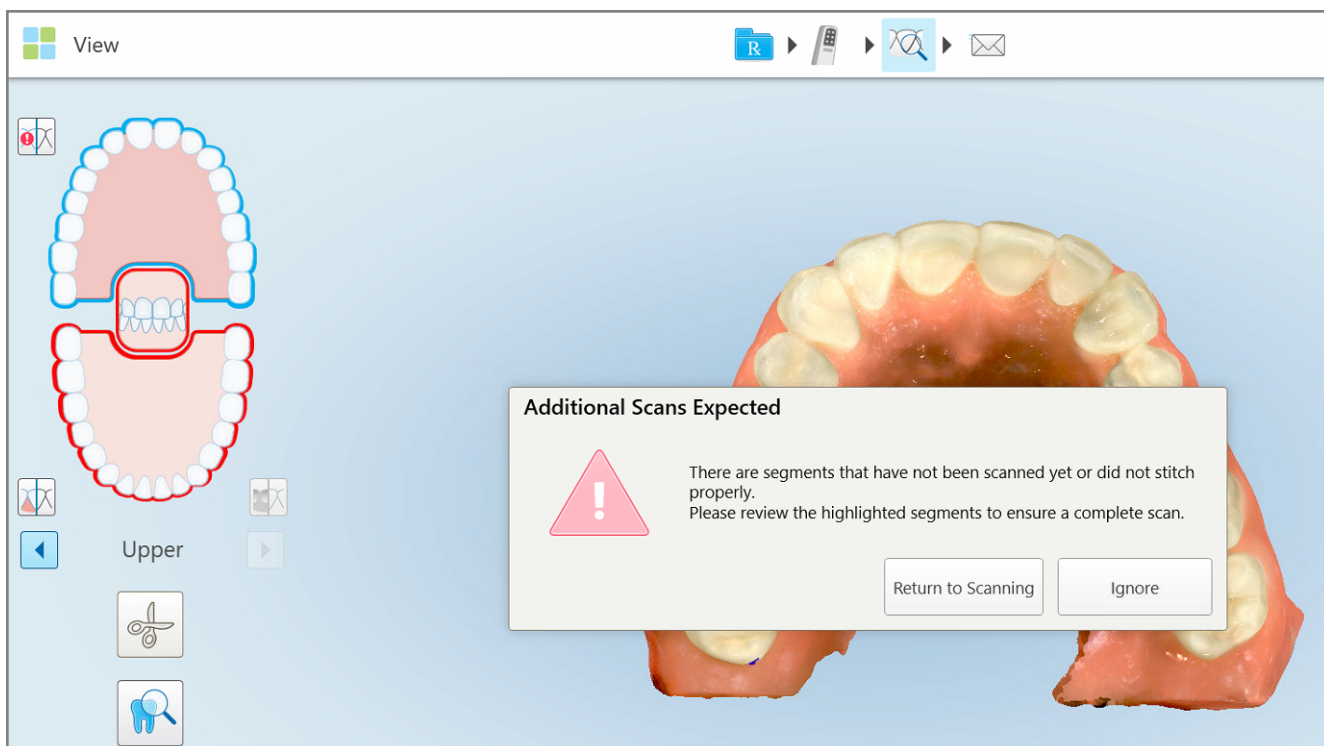

Figure 140: Missing scan message and missing segments highlighted in red

You can tap **Return to Scanning** to go back to Scan mode and rescan the missing segments, which are highlighted in red in the navigation controls.

## 5.6.2 Using the scan timer

The scan timer enables you to see how long it took to scan the model.

**To view the scan time:**

1. On the toolbar, tap the  button.

The scan time is displayed.

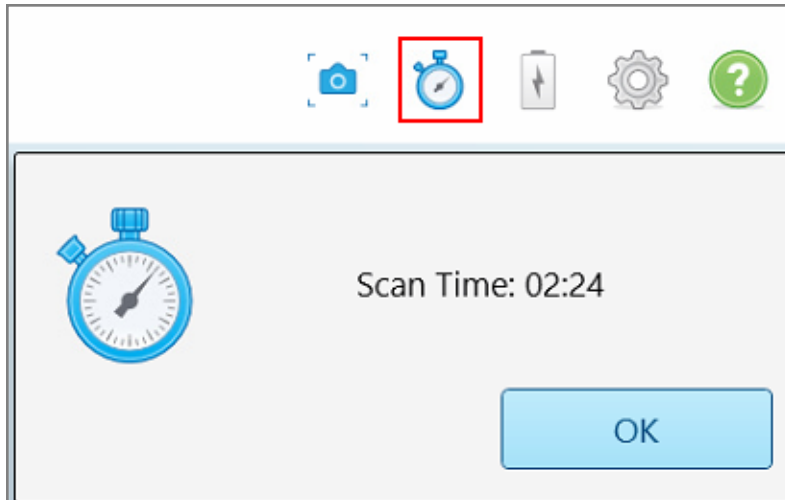

Figure 141: Scan timer button on the toolbar and scan time

2. Tap **OK** to close the window.

## 5.7 Sending the scan

After you have scanned the patient and reviewed the Rx to ensure that no data is missing, you can send the scan to the lab, your chairside milling software, or to your MyiTero account, depending on the procedure.

### Notes:

- Ensure that the wand is placed back in the cradle, with the optical window facing the cradle, before sending the scan.
- Before you can send the scan, you have to confirm that you have received the patient's consent to have their health data collected and processed by Align for the purposes of dental care and for further processing in accordance with your End User License Agreement.
- The wand lights may flicker during the sending process.
- Evaluate the fitting of the dental devices manufactured using the data generated from the scanner according to the standard of care procedure.

**To send the scan:**

1. Tap  on the toolbar to send the scan, including screenshots of the scanned model, if relevant.

**Note for Fixed Restorative and Denture/Removable procedures:** Some fields in the Rx become mandatory only after the patient has been scanned. If you have not completed all the mandatory information required, a message is displayed prompting you to fill in the missing fields.

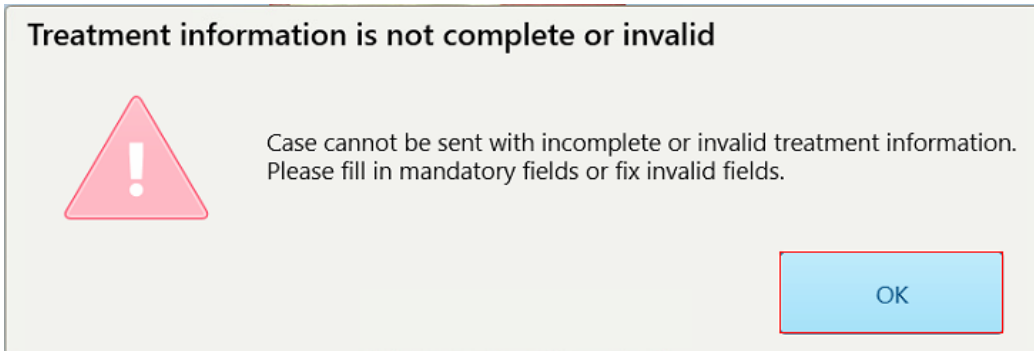

Figure 142: Notification about missing treatment information

- a. Tap **OK** to display the *Rx Details* page, showing a notification in the **Treatment Information** area for each treatment missing required fields.

Treatment Information					
Bridge : 14 - 16					
Tooth No.	Treatment	Specification	Material	Shade Body	
14	Implant Based	-	-	-	Show Details
Required Fields are Missing for Treatment					
15	Pontic	-	-	-	Show Details
Required Fields are Missing for Treatment					
16	Implant Based	-	-	-	Show Details
Required Fields are Missing for Treatment					

Figure 143: Missing fields highlighted in red in the Treatment Information area

- b. Tap **Show Details** to open the treatment options and fill in the missing details.

- c. Tap  to send the scan.

The *Complete Scan* window is displayed.

If you selected to attach files, a yellow banner is displayed at the bottom of the window notifying you that your order will be placed on hold until you send it from MyiTero.

2. Sign in the signature area to authorize the order.

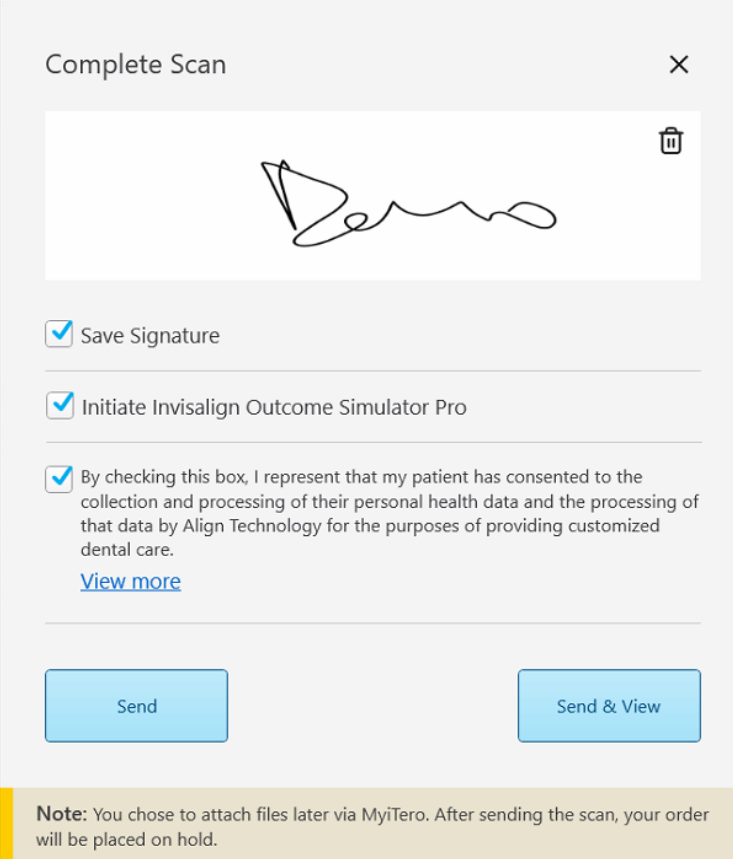

Complete Scan

×

🗑️

✓ Save Signature

✓ Initiate Invisalign Outcome Simulator Pro

✓ By checking this box, I represent that my patient has consented to the collection and processing of their personal health data and the processing of that data by Align Technology for the purposes of providing customized dental care.

[View more](#)

Send Send & View

**Note:** You chose to attach files later via MyiTero. After sending the scan, your order will be placed on hold.

Figure 144: Complete Scan window with yellow banner for orders on hold

3. If required, select the **Save Signature** check box to save your signature for authorizing sending future scans.
4. If you have scanned a Study Model/iRecord procedure or an Invisalign Aligners procedure type, the **Initiate Invisalign Simulator Pro** check box is displayed and selected. Keeping this option selected will trigger the simulation. For more information regarding Invisalign Outcome Simulator Pro, see [Invisalign Outcome Simulator Pro](#).

**Note:** In order to enable the simulation, ensure that your iTero account is paired with your Invisalign Doctor Site account.

5. Ensure that the patient consent check box is selected, confirming that you have received the patient's consent to have their health data collected and processed by Align for the purposes of dental care and for further processing in accordance with your End User License Agreement.
6. Tap **Send** to send the scan or **Send & View** to send the scan and open it in Align Oral Health Suite, as described in [Align Oral Health Suite](#).

A notification is displayed that the model is being sent, and depending on the send option you tapped, either the patient's profile page is displayed showing the status of the order or the scan is displayed in Align Oral Health Suite.

If you selected to run an Invisalign Outcome Simulator Pro simulation and tapped **Send**, the Viewer is displayed showing the progress of the simulation.



Figure 145: Invisalign Outcome Simulator Pro progress shown in the Viewer

You can also view the progress of the simulation in the patient's profile page.

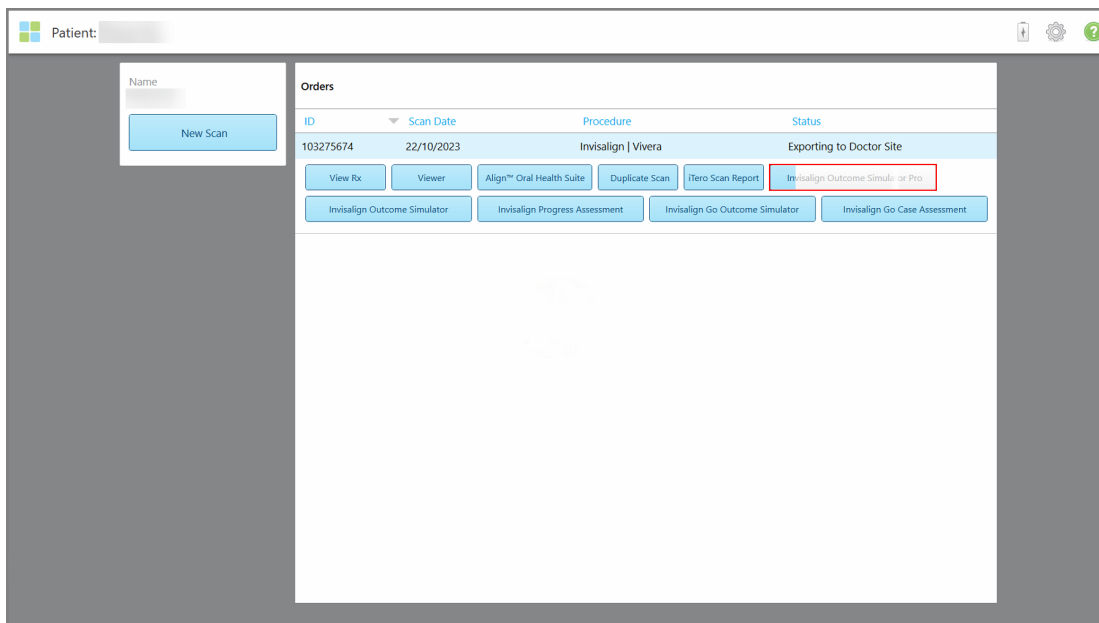

Figure 146: Invisalign Outcome Simulator Pro progress shown in the patient's profile page

If you did not select to run Invisalign Outcome Simulator Pro, a notification is displayed that the model is being sent and then the patient's profile page is displayed showing the status of the order.

## 5.8 Working with the Viewer

The Viewer is a tool that enables you to view and manipulate the digital model for case presentations. Only scans that have already been sent can be viewed in the Viewer.

The Viewer can be accessed from Past Orders in the *Orders* page, or from a specific patient's profile page.

Past Orders					
ID	Patient Name	Chart Number	Scan Date	Procedure	Status
103161042	[REDACTED]		08/06/2022	Study Model/iRecord	Completed
103158019	Demo, Patient1	123	08/06/2022	Study Model/iRecord	Completed
<div style="display: flex; justify-content: space-between; align-items: center;"> <span>View Rx</span> <span style="border: 2px solid red; padding: 2px;">Viewer</span> <span>Align™ Oral Health Suite</span> <span style="color: green;">✔</span> Invisalign Outcome Simulator Pro                     <span>Invisalign Go Outcome Simulator</span> <span>Invisalign Go Case Assessment</span> </div>					
103053541	[REDACTED]		08/04/2022	Invisalign   Vivera	Completed
103053113	[REDACTED]		08/04/2022	Study Model/iRecord	Completed
102880155	[REDACTED]		08/03/2022	Study Model/iRecord	Completed

Figure 147: Viewer option in the Past Orders pane in the Orders page

← Patient: Demo, Patient1
⌵ ⚙️ ?

Name  
Demo, Patient1

Chart Number  
123

Date of Birth  
03/20/1983

Gender  
Female

New Scan

**Orders**

ID	Scan Date	Procedure	Status
103158019	08/06/2022	Study Model/iRecord	Completed
<div style="display: flex; justify-content: space-between; align-items: center;"> <span>View Rx</span> <span style="border: 2px solid red; padding: 2px;">Viewer</span> <span>Align™ Oral Health Suite</span> <span style="color: green;">✔</span> Invisalign Outcome Simulator Pro                             <span>Invisalign Go Outcome Simulator</span> </div> <div style="margin-top: 5px;"> <span>Invisalign Go Case Assessment</span> </div>			

Figure 148: Viewer option in the patient's profile page

In the Viewer, you can tap the following to:



Show/hide the upper jaw.

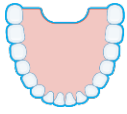

Show/hide the lower jaw.



Show both jaws.



Open the Review tool to view an area of interest, as described in [Working with the Review tool](#).



Display the Invisalign Outcome Simulator Pro tool, as described in [Invisalign Outcome Simulator Pro](#). Available only for Study Model/iRecord procedures and Invisalign Aligners procedure types.



Display the model in a 1-window view, with the upper and lower jaws in the same window (Frontal view).



Figure 149: Model in a 1-window view

Relevant for Orthodontic procedures only.



Display the model in a 2-window view, with the upper and lower jaws in separate windows (Occlusal view). Each model can be controlled separately, for better evaluation.

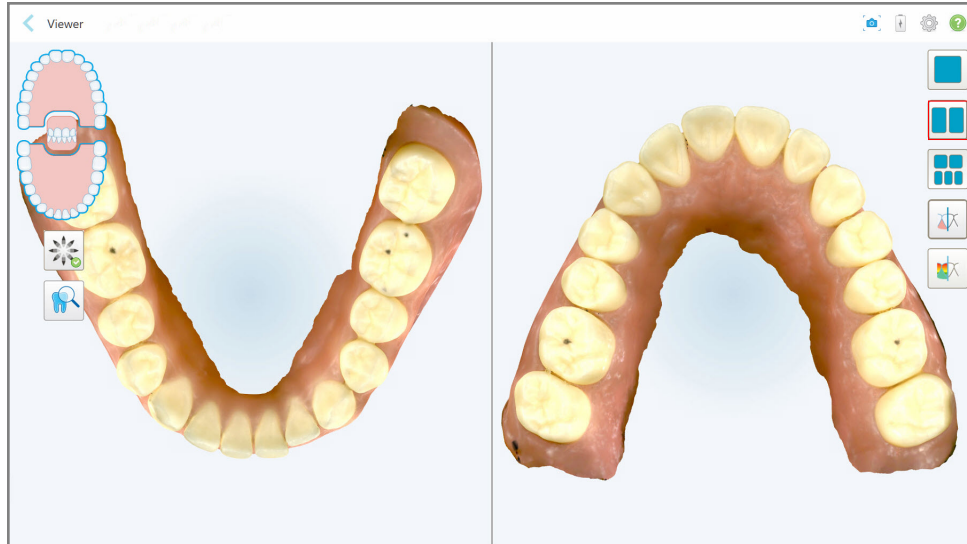

Figure 150: Model in a 2-window view

Relevant for Orthodontic procedures only.



Display the model in a 5-window view, with the upper and lower jaws separately, and both jaws from the left, center, and right (Gallery view). Each model can be controlled separately, for better evaluation.

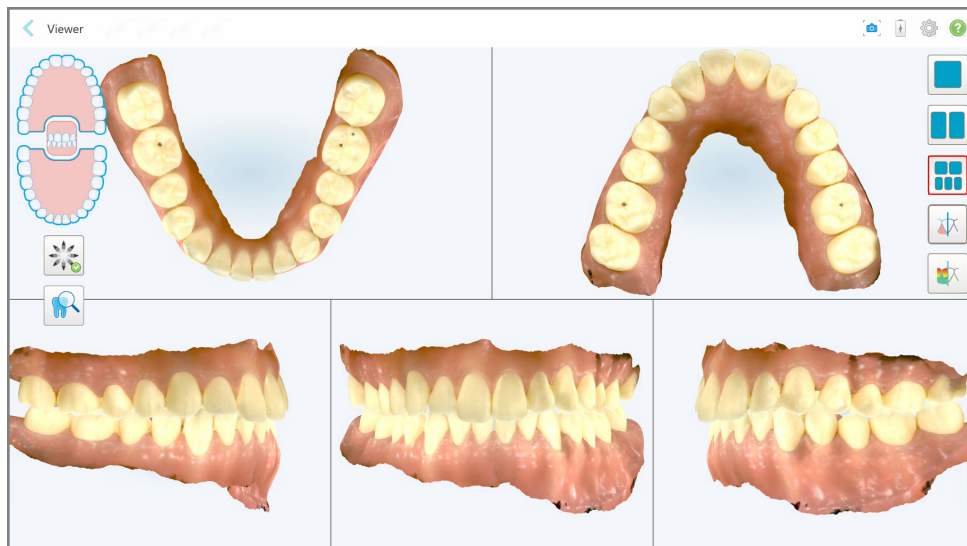

Figure 151: Model in a 5-window view

Relevant for Orthodontic procedures only.



Display/hide the margin line of the prepped tooth.

Relevant for Restorative procedures only.



Show/hide the ditch created by the Modeling team. This will be enabled in the Viewer only after the modeling phase.

Relevant for Restorative procedures only.



Toggle between viewing the model in color or monochrome.



Show/hide the occlusal clearance between the opposing teeth, as described in [Working with the Occlusal Clearance tool](#). This option is enabled only if the bite was scanned.

**Note:** When the case status is **iTero Modeling**, it is in the early stages of modeling, and the margin line and die tools are disabled.

When the modeling process is completed, and the die and margin line have been edited, the changes appear in color on the model and the tools are displayed in color, indicating that they are active.

## 5.9 Removing the sleeve

Before removing and disposing of the sleeve, see the **iTero Lumina sleeves** section in the [Safety instructions](#).

**To remove the wand sleeve:**

1. Once the scan is complete, or if the scan has been interrupted, slowly pull the sleeve off the wand, and discard it.

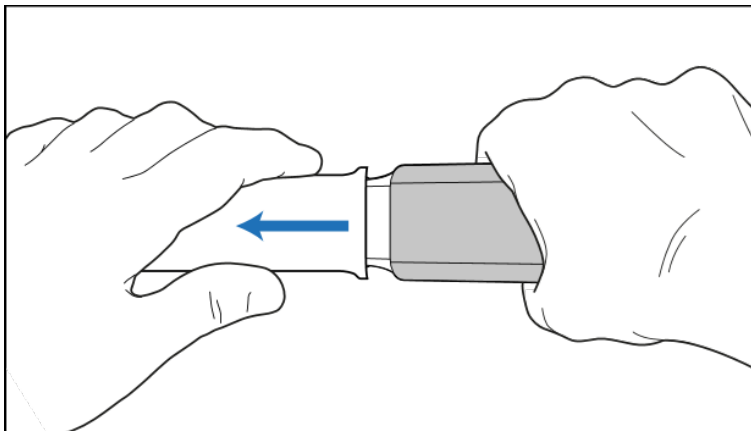

Figure 152: Removing a wand sleeve

**Note:** OPTICAL SURFACE!

DO NOT touch the optical surface of the wand. Contact may cause damage. If additional cleaning, besides that described in [Wand cleaning and disinfection](#) is necessary, use the anti-static cloth found inside the sleeve box. For more information, refer to the instructions in the box.

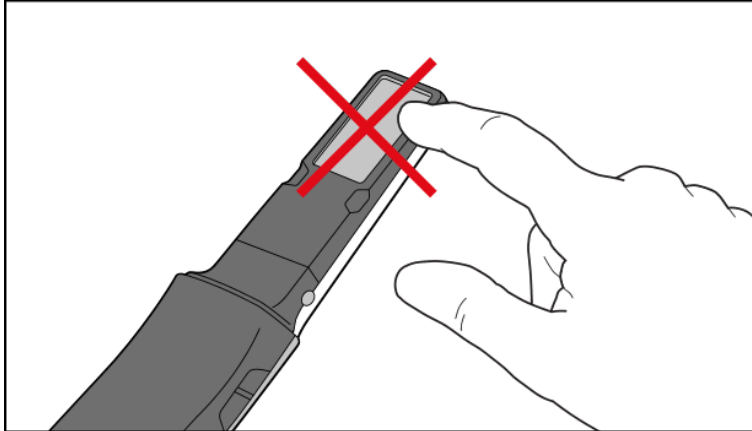

Figure 153: Optical surface of the wand

2. Clean and disinfect the wand, as described in [Cleaning and disinfecting the wand](#).
3. Gently slide a new sleeve onto the tip of the wand until it clicks into place.

**Note:** If the scanner will not be used immediately after cleaning and disinfection, attach the dark protective sleeve.

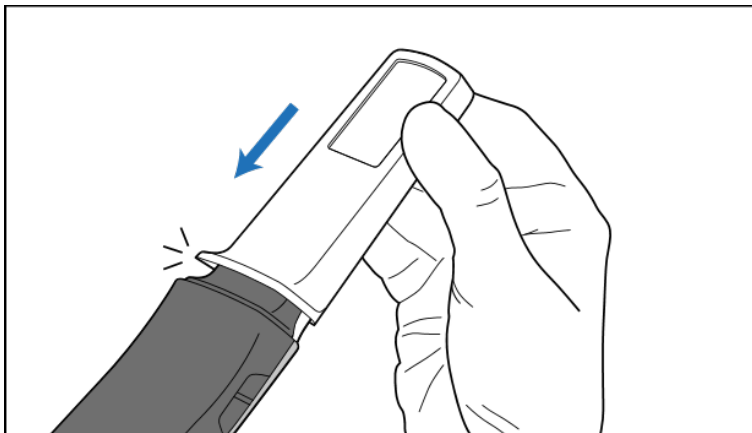
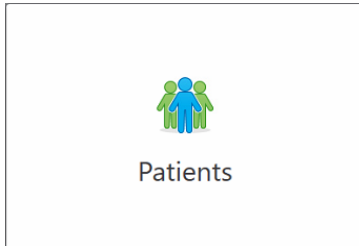

Figure 154: Gently slide the new sleeve into place

## 6 Working with patients

On the home screen, tap the **Patients** button to display the *Patients* page.



The *Patients* page displays a list of all patients registered in your iTero system, and if relevant, their chart number, date of birth, and the date of their last scan.

Patient Name	Chart Number	Date of Birth	Last Scan Date
[Blurred]			08/04/2022
[Blurred]			08/03/2022
[Blurred]			07/31/2022
[Blurred]			07/26/2022
[Blurred]			07/25/2022
[Blurred]			07/21/2022
[Blurred]			07/19/2022
[Blurred]			06/22/2022
[Blurred]			02/15/2022
[Blurred]			01/26/2022
[Blurred]			11/16/2021
[Blurred]			11/09/2021
[Blurred]	12345	[Blurred]	05/27/2021
[Blurred]			04/29/2021
[Blurred]			04/29/2021
[Blurred]			02/07/2021

Figure 155: Patients page

Once you have selected a patient, you can view the patient's profile page with the patient's details.

### 6.1 Searching for patients

If required, you can search for patients in the iTero database using their names or chart numbers.

**To search for a patient:**

- In the *Patients* page, enter the patient's name or chart number (or part thereof) in the search field and then tap the search button .

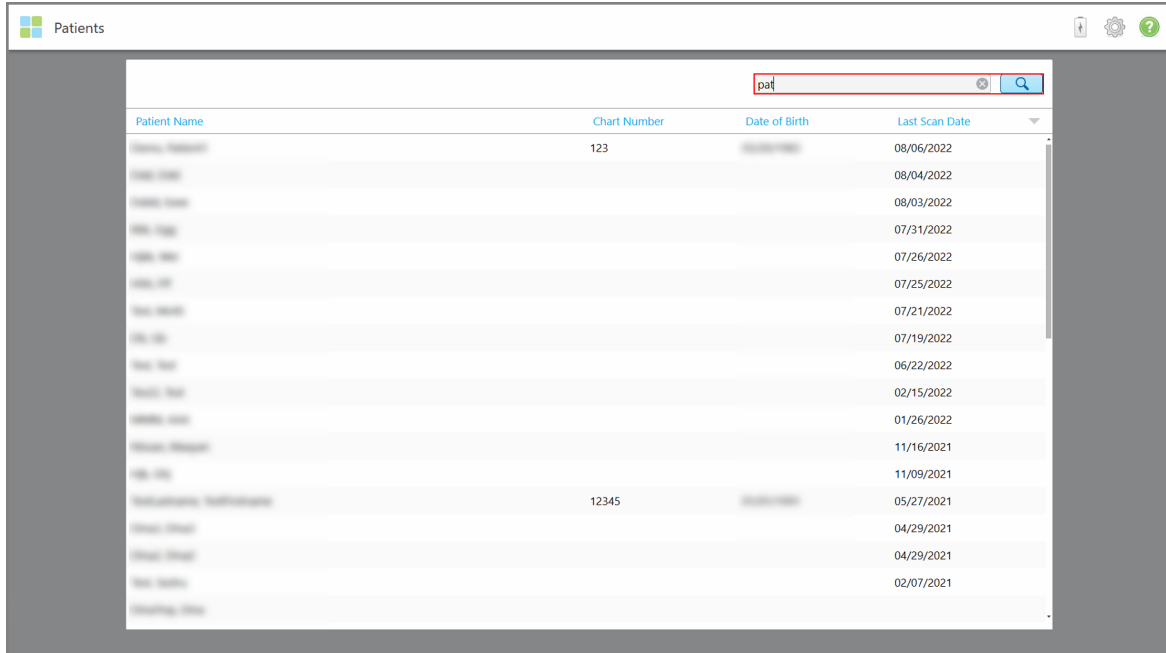
**Figure 156: Searching for a patient**

The patients that match the search criteria are displayed.

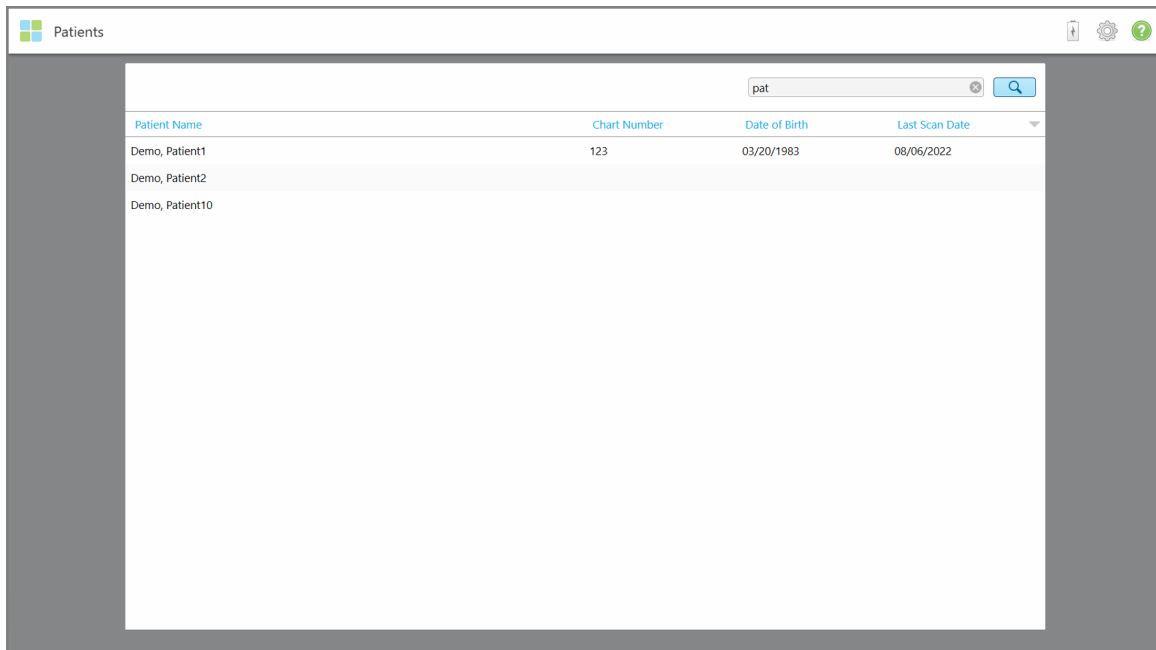
**Figure 157: Patients matching the search criteria are displayed**

## 6.2 Viewing the patient details

You can view the patient's details, including all the patient's previous scans, in the patient's profile page.

### To view the patient details:

1. Tap the **Patients** button on the home screen.

The *Patients* page is displayed, showing a list of patients, their chart number, and the date of their last scan.

2. Select the required patient in the list.

The selected patient's profile page is displayed:

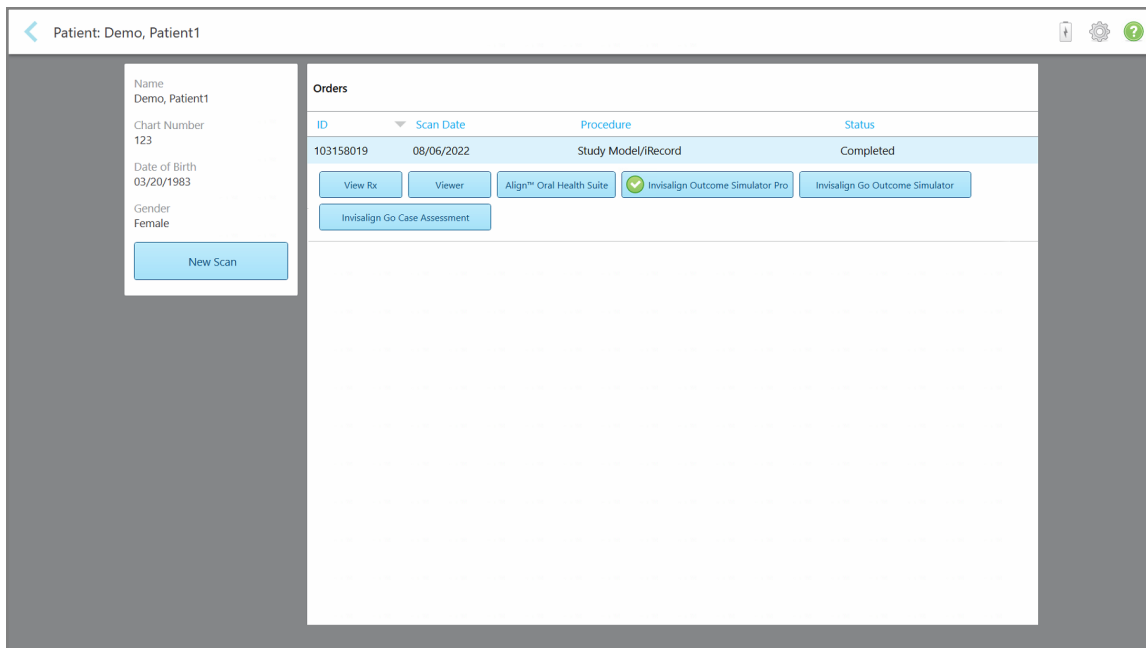

**Figure 158: Patient's profile page**

From the patient's profile page, you can:

- Create a new scan for the specific patient, described in [Creating a new scan for a specific patient](#).
- View the Rx details and edit the patient's details, described in [Viewing the Rx](#).
- View the patient's previous scans in the Viewer, described in [Viewing previous scans in the Viewer](#).
- Compare 2 previous scans using iTero TimeLapse technology, described in [Comparing previous scans using iTero TimeLapse technology](#).
- View any Invisalign-related processes.

### 6.3 Creating a new scan for a specific patient

If required, you can create a new scan for a specific patient. The Rx opens with the patient's details already filled in.

**To create a new scan for a specific patient:**

1. In the patient's profile page, tap **New Scan**.

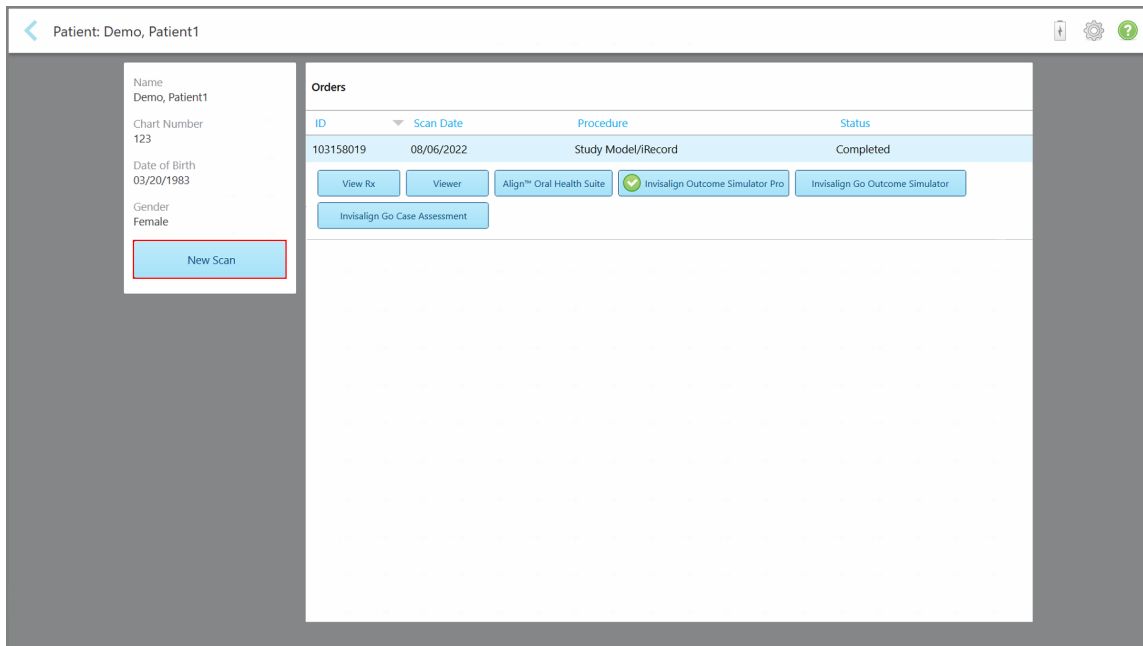

Figure 159: Patient's profile page – New Scan option

The *New Scan* window is displayed, with the patient's details already filled in.

The screenshot shows the 'New Scan' window with the following details filled in:

- Doctor: Dr. Demo, Demo
- License: 12345
- Patient:
  - First Name: Patient1
  - Last Name: Demo
  - Date of Birth: 20/03/1983
  - Chart Number: 123
  - Gender:  Male  Female
- Order:
  - Procedure \* (dropdown)
  - Type (dropdown)
  - Due Date: (dropdown)
  - Send to (dropdown)
- Scan Options:
  - New Sleeve Attached:
- Notes:
  - Add Note (button)

Figure 160: New Scan window with patient's details already filled in

2. Fill in the rest of the Rx details according to the new requirements.

## 6.4 Viewing the Rx

If required, you can view the Rx of a previous order.

**To view the Rx of a previous order:**

1. In the patient's profile page, select the order for which to view the Rx and then tap **View Rx**.

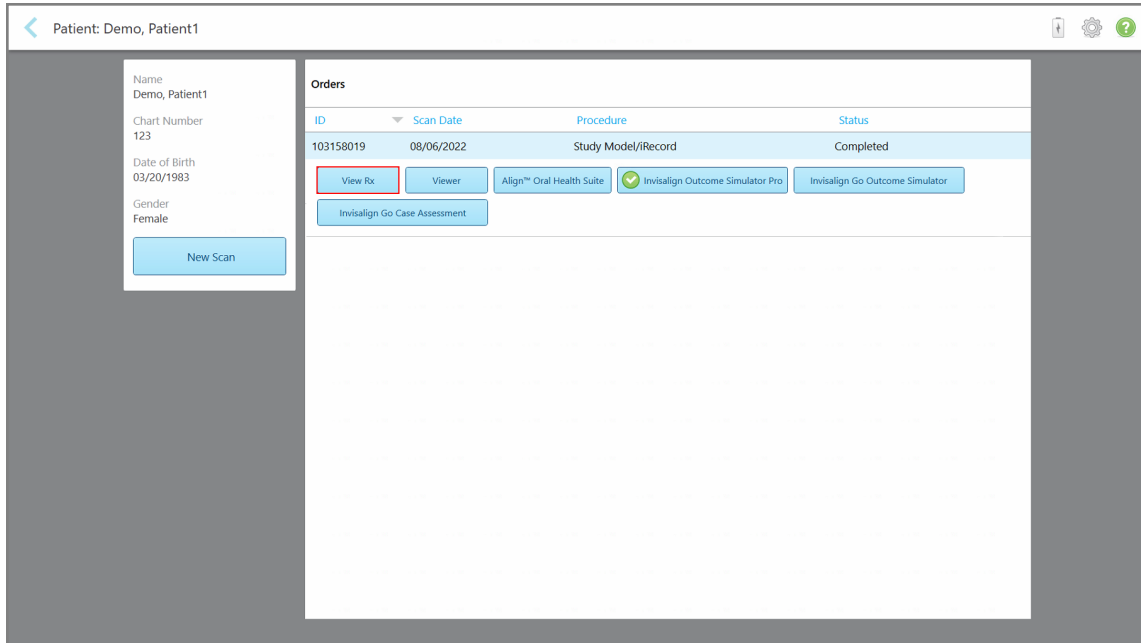



Figure 161: Patient's profile page – View Rx option

The *Rx Details* window is displayed.

The screenshot shows the 'Rx Details' window with the following content:

- Header: Rx Details (with back arrow, settings, and help icons)
- Read-only notice: This Form Is Read-only.
- Doctor: Dr. Demo, Demo; License: 12345
- Patient section:
  - First Name: Patient1; Last Name: Demo
  - Date of Birth: 20/03/1983; Gender:  Male  Female
  - Chart Number: 123
- Order section:
  - Notice: All Study Model/iRecord scans are available for Invisalign.
  - Procedure: Study Model/iRecord; Ortho Model/iCast:
  - Due Date: ; Send to: (dropdown)
- Scan Options:
  - New Sleeve Attached: ; Multi-Bite:
- Notes: (empty text area)

Figure 162: Rx Details window

2. Tap  to return to the patient's profile page.

## 6.5 Viewing previous scans in the Viewer

If required, you can display previous scans in the Viewer.

**To view a previous scan in the Viewer:**

1. In the patient's profile page, tap the scan you want to display in the Viewer and then tap **Viewer**.

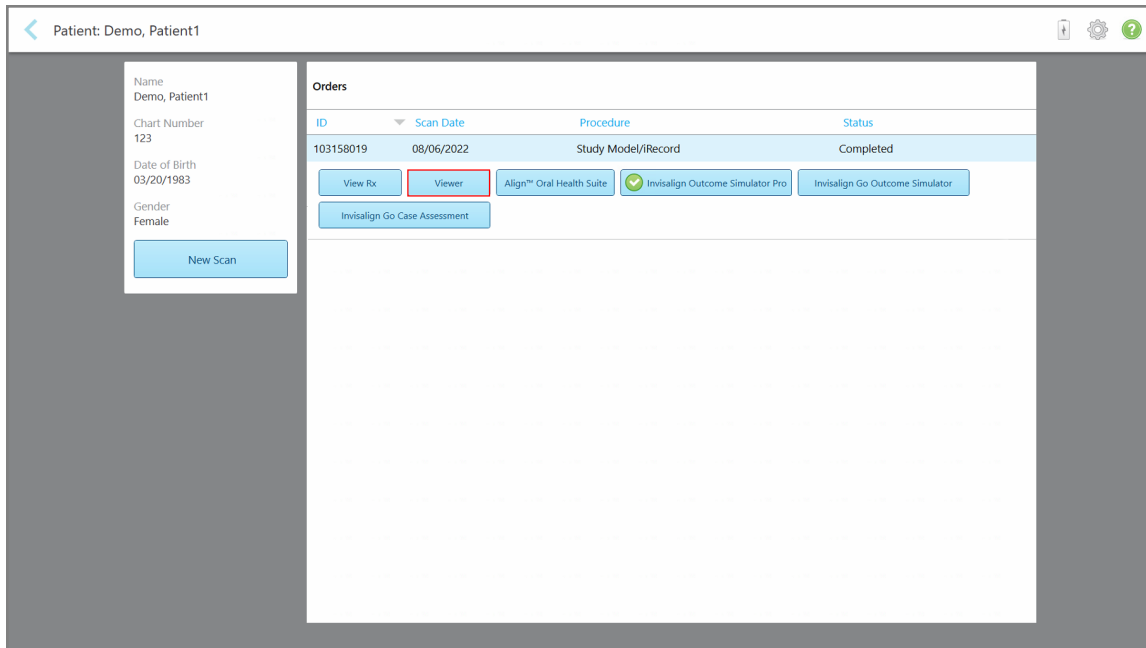

Figure 163: Patient's profile page – Viewer option

The scan is displayed in the Viewer.

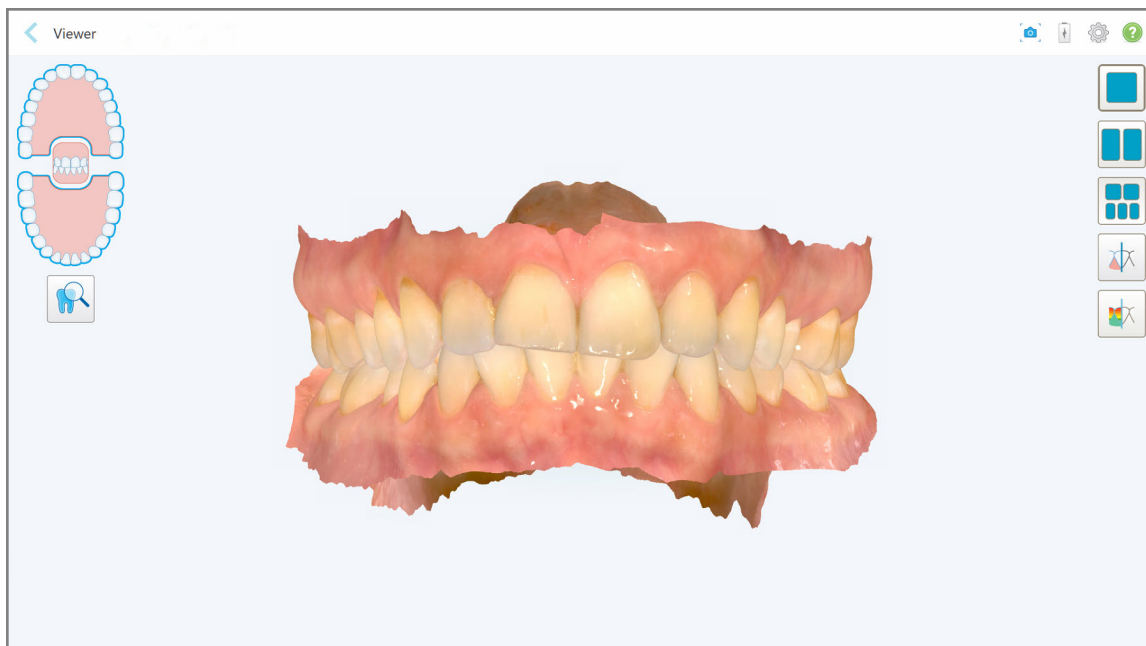
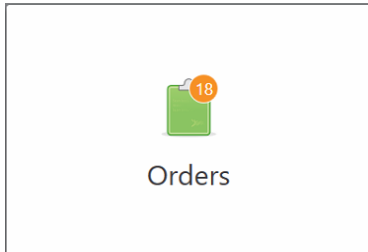

Figure 164: Scan displayed in the Viewer

For more information on working with the Viewer, see [Working with the Viewer](#).

## 7 Working with orders

Tap the **Orders** button to display a list of all your orders. The button may contain a badge that indicates the number of orders that have not been submitted yet.



If an order has been returned from the lab, the button is displayed in red, with an alarm icon badge, as described in [Working with returned orders](#).

The *Orders* page is made up of two panes listing the orders that are still in progress and the ones that have already been submitted.

You can view the following details for each order: the order ID, patient's name, chart number, the scan date, procedure, and the status of the order.

The order could have one of the following statuses, depending on the procedure:

- **Rx Created:** The Rx has been filled in, but the patient has not been scanned yet.
- **Scanning:** The scan process is in progress.
- **Sending:** The scan is in the process of being sent.
- **Sent:** The scan has been sent.
- **Failed to Send:** The scan was not sent.
- **Pending attachments:** The scan has been sent from the scanner but is on hold until you upload the required attachments and send the scan from MyiTero.
- **iTero Modeling:** The scan has been sent to iTero Modeling.
- **Ortho Modeling:** The scan has been sent for modeling.
- **Returned:** The scan was rejected by the lab and has been sent back for rescanning or other adjustments, as described in [Working with returned orders](#).
- **Align Production:** The scan is undergoing an internal process.
- **Exporting to Doctor Site:** The scan is on the way to the IDS portal.
- **Completed:** The flow has been completed.

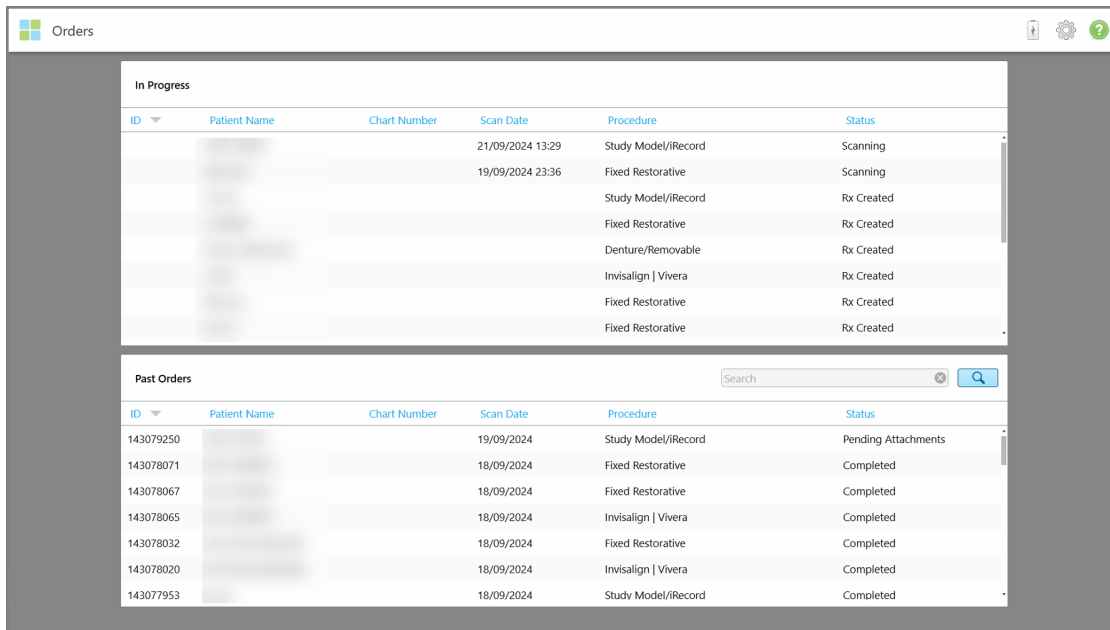

Figure 165: Orders page

**To view or review orders:**

1. Tap the **Orders** button on the home screen.

The *Orders* page is displayed, showing two panes – **In Progress** orders and **Past Orders**.

- **In Progress:** Scans that have not yet been submitted.
- **Past Orders:** Scans that have already been submitted.

2. Tap on an order in the **In Progress** pane to view the following options:

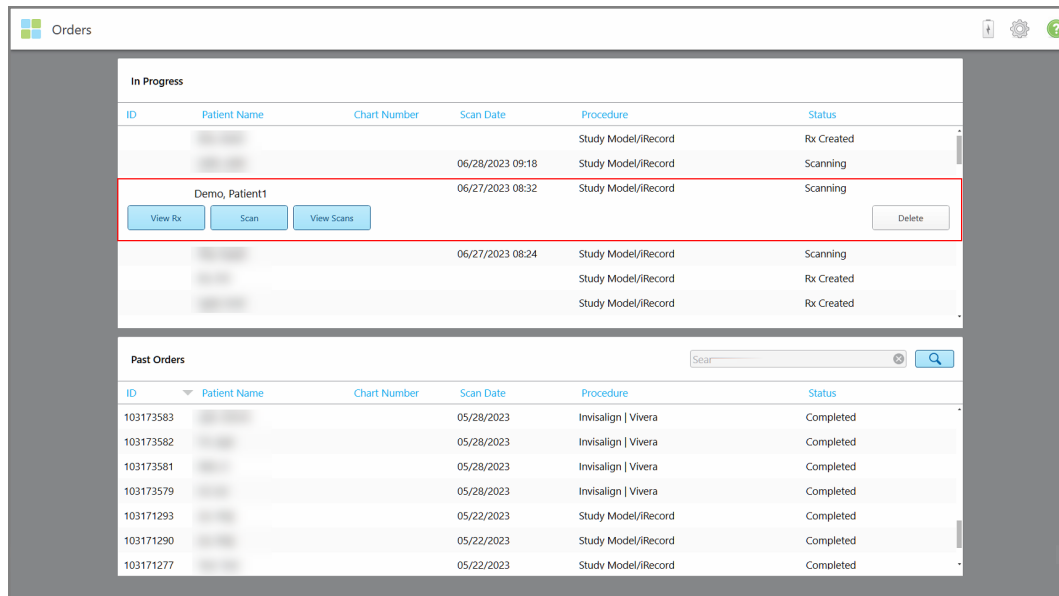

Figure 166: In Progress pane – options

- **View Rx:** Opens the *Rx Details* window, enabling you to view the prescription for this order.
  - **Scan:** Opens the *Scan* window, enabling you to create a new scan or continue scanning the patient.
  - **View Scans:** Opens the *View* window, enabling you to review the current scan.
3. Tap an order in the **Past Orders** pane to view the following options, depending on the procedure and your iTero subscription package:

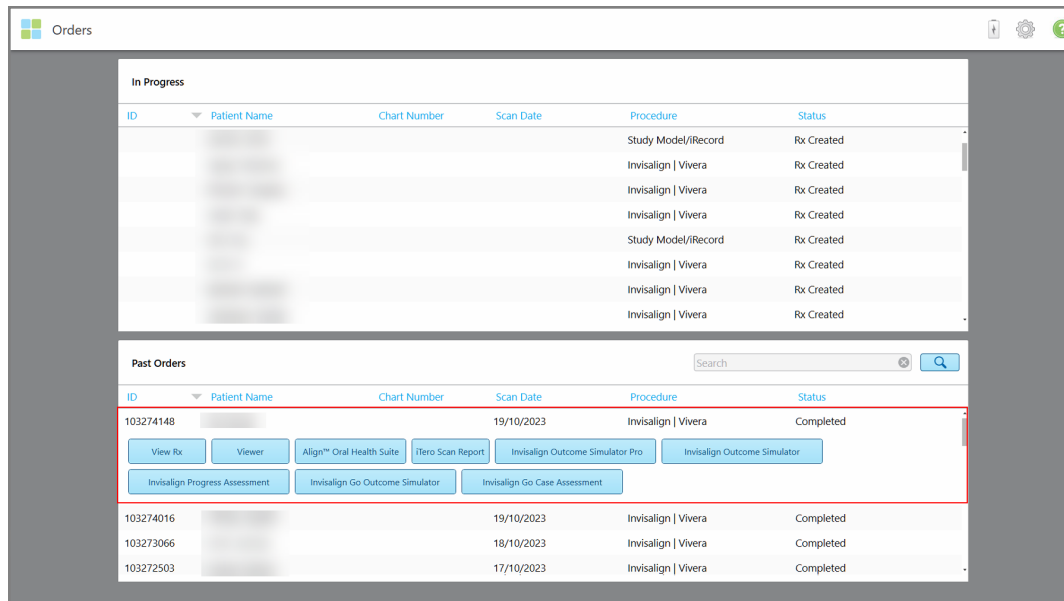

Figure 167: Past Orders pane – options

- **View Rx:** Opens the *Rx Details* window, enabling you to view the prescription for this order.
- **Viewer:** Opens the *Viewer* window, enabling you to view and manipulate the model. For more information on working with the Viewer, see [Working with the Viewer](#).
- **Align Oral Health Suite:** Opens Align Oral Health Suite and enables you to view the scan in the context of select dental conditions. For more information, see [Align Oral Health Suite](#).
- **Duplicate Scan:** Opens the *New Scan* window of a previously scanned orthodontic or Fixed Restorative order and enables you to adapt it as follows:
  - Study Model/iRecord, Invisalign | Viverra, Appliance orders – you can duplicate the scan and then send it as a Fixed Restorative case, for example, after adding only the prepped area.
  - Fixed Restorative order – you can duplicate the scan and then add additional indications, for example, additional crowns, etc.

This option is available only for a short period after the scan, depending on scanner resources.
- Invisalign users can also select the following Invisalign features:
  - [Invisalign Outcome Simulator Pro](#)
  - [Invisalign Outcome Simulator](#)
  - [Invisalign Progress Assessment](#)
  - [Invisalign Go system](#)

## 7.1 Working with returned orders

Labs can return orders within 30 days if the scan is incomplete and needs to be rescanned, for example, if there are missing scans, bite issues, or if the margin line is not clear. If the lab returns an order, the **Orders** button is highlighted in red with an alarm icon badge.

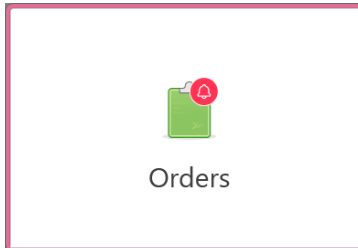

Figure 168: Orders button notifying a returned order

The returned order is displayed at the top of the **In Progress** pane, with the status **Returned**, in red.

 The screenshot shows the "Orders" interface. At the top left, there is a logo and the word "Orders". On the right, there are icons for a list, settings, and help. The main area is divided into two panes: "In Progress" and "Past Orders".
   
 The "In Progress" pane contains a table with the following data:
 

ID	Patient Name	Chart Number	Scan Date	Procedure	Status
103181639	Demo, Patient1	123	08/07/2022 00:52:32	Appliance	Returned
		12345		Invisalign   Vivera	Rx Created
				Invisalign   Vivera	Rx Created
				Invisalign   Vivera	Rx Created
				Invisalign   Vivera	Rx Created
				Study Model/iRecord	Rx Created
				Invisalign   Vivera	Rx Created
				Study Model/iRecord	Rx Created

 The "Past Orders" pane contains a search bar and a table with the following data:
 

ID	Patient Name	Chart Number	Scan Date	Procedure	Status
102880155			08/03/2022	Study Model/iRecord	Completed
103053113			08/04/2022	Study Model/iRecord	Completed
103158019		123	08/06/2022	Study Model/iRecord	Completed
103161042			08/06/2022	Study Model/iRecord	Completed
102036203			07/24/2022	Appliance	Completed
102180850			07/26/2022	Invisalign   Vivera	Completed
99976922			06/28/2022	Invisalign   Vivera	Completed

Figure 169: Returned order in the In Progress pane

### To fix a returned order:

1. Open the returned order and fix the scan according to the lab's instructions in the **Notes** area of the Rx.
2. Return the order to the lab.

## 8 Viewing messages

The *Messages* page displays notifications, updates, and other system messages from Align Technology, for example, product updates, upcoming educational sessions, or internet connectivity issues.

If relevant, you can view the number of new or unread messages on the badge on the **Messages** button.

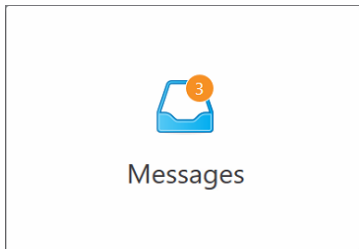

### To view the messages:

1. Tap the **Messages** button on the home screen.

A list of notifications, updates, and other messages from Align Technology is displayed.

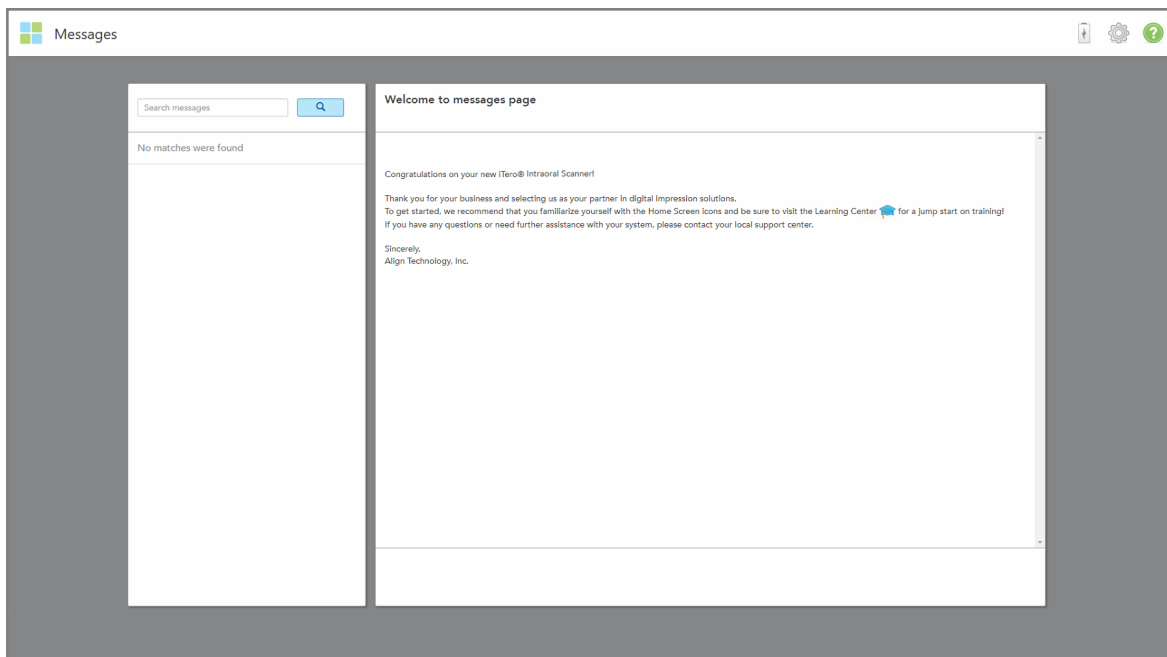

Figure 170: Messages page

2. In the left pane, quickly search for a specific message by subject title or scroll down the pane to find a specific message.
3. To mark any message as unread, tap **Mark as Unread**.

## 9 Working with MyiTero

MyiTero is a web-based portal, with the same look-and-feel as the iTero software. It enables users to carry out administrative tasks such as filling in a new Rx on any supported device, for example, a PC or a tablet, without using valuable scanner time. In addition, it enables viewing 3D models after they have been created by the scanner, and tracking orders.

## 10 iTero scanner features and tools

This section describes the following iTero scanner features and tools:

- [Comparing previous scans using iTero TimeLapse technology](#)
- [Invisalign Outcome Simulator Pro](#)
- [Invisalign Outcome Simulator](#)
- [Invisalign Progress Assessment](#)
- [Invisalign Go system](#)
- [Editing tools](#)
  - [Deleting a segment](#)
  - [Working with the Trim tool](#)
  - [Working with the Eraser tool](#)
  - [Disabling auto-cleanup](#)
  - [Enabling saliva detection](#)
- Scan tools:
  - [Working with the Occlusal Clearance tool](#)
  - [Working with the Die Separation tool](#)
  - [Working with the Margin Line tool](#)
  - [Working with the Review tool](#)
  - [Working with the Snapshot tool](#)

### 10.1 Comparing previous scans using iTero TimeLapse technology

Patients who are scanned regularly can have their scans analyzed using iTero TimeLapse technology.

iTero TimeLapse technology compares 2 of the patient's previously captured 3D scans to allow visualization of the changes in the patient's teeth, tooth structure, and oral soft tissues over the period between the scans. For example, iTero TimeLapse technology can display tooth wear, gingival recession, and tooth movement over the relevant period.

**Note:** iTero TimeLapse technology is available for Orthodontic procedures only.

#### To use iTero TimeLapse technology:

1. In the *Patients* page, select the patient for whom to create an iTero TimeLapse visualization.
2. In the patient's profile page, select two scans to compare. You can select the scans by selecting the check boxes next to the relevant orders, or by selecting the check boxes in the **Timeline** area at the bottom of the page.

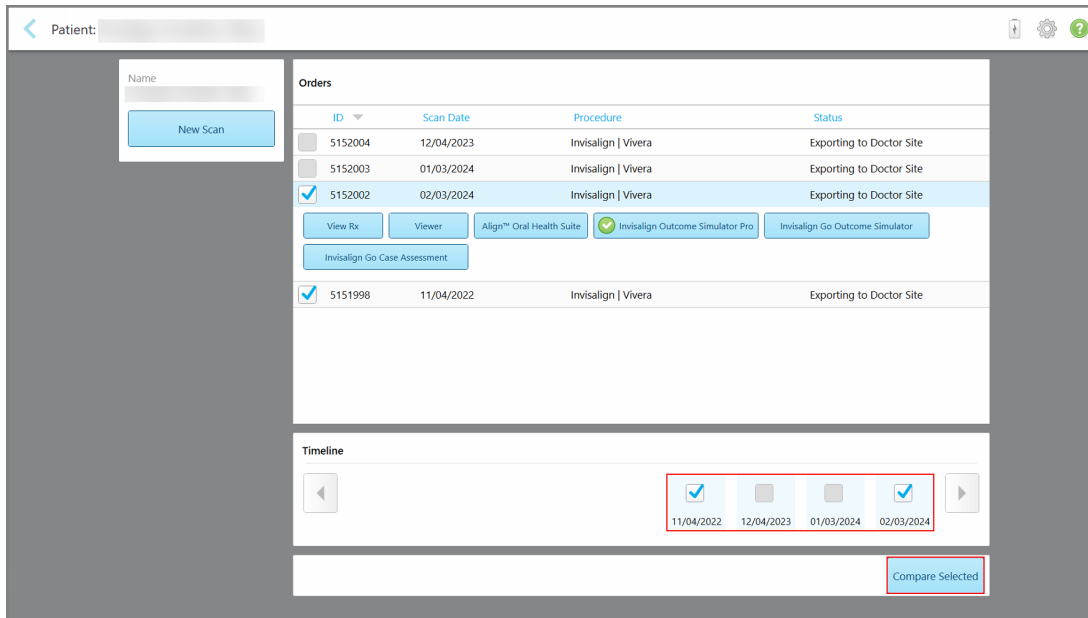

Figure 171: iTero TimeLapse – selecting the scans to compare

3. Tap the **Compare Selected** button to compare and analyze the scans.

The *iTero TimeLapse* window is displayed, highlighting the areas with changes between the scans. The darker the color, the bigger the change between the scans, as displayed in the legend.

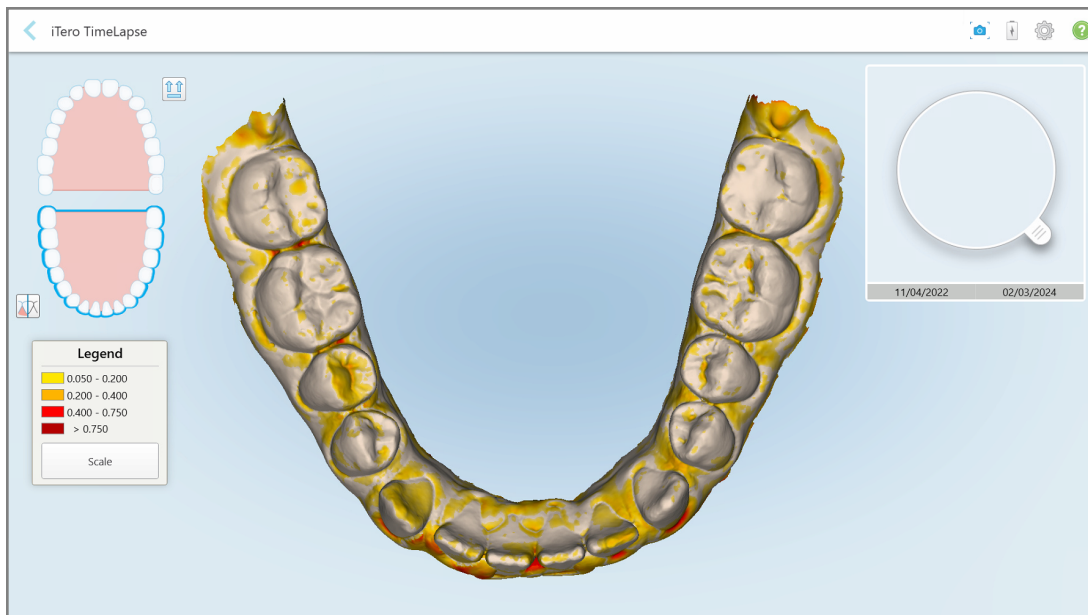



Figure 172: iTero TimeLapse window showing the highlighted changes between the scans

**Note:** Changes are highlighted only when the scans are displayed in monochrome mode.

If required, tap  to move the scan to the default occlusal view – lower arch with anterior teeth at the bottom and upper arch with anterior teeth at the top and both arches in a frontal view like the iRecord default view.

4. Drag the loupe onto the model to view areas of interest and potential treatment areas in the animation window. An animation is displayed, comparing the state of the teeth in the current area of interest on the selected scan dates.

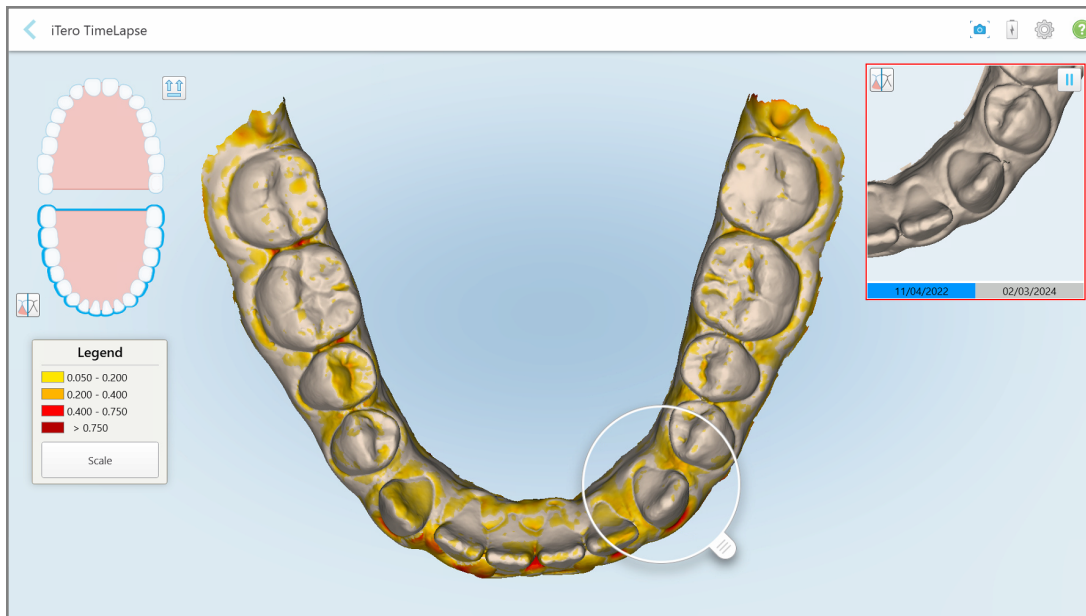

Figure 173: Area of interest from the first scan displayed in the animation window

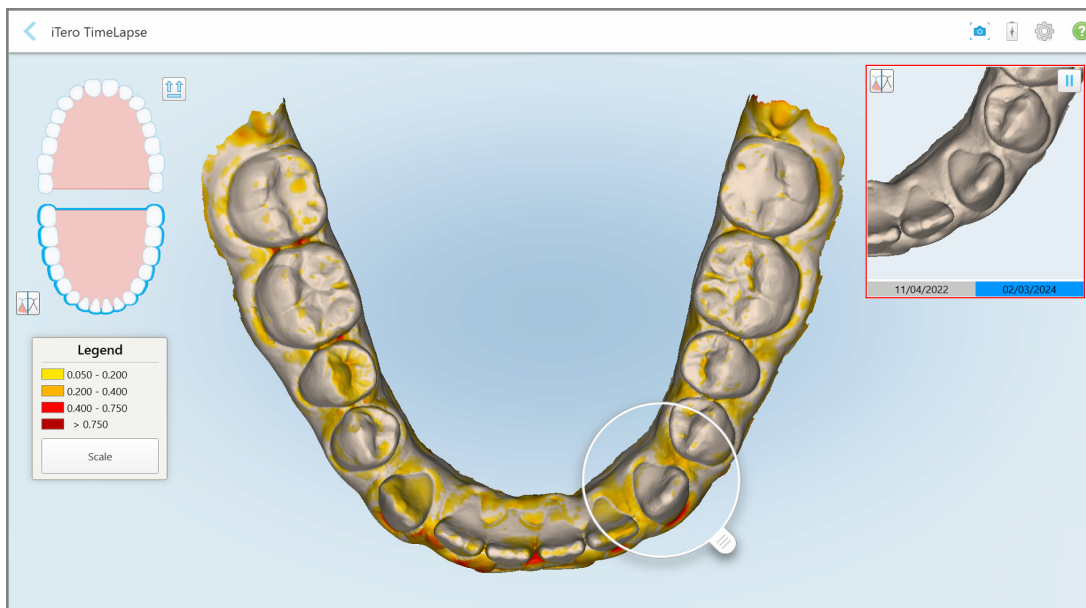



Figure 174: Area of interest from the second scan displayed in the animation window

You can zoom in to the image in the animation window or tap the pause button  to pause the animation. If required, you can change the scale of the changes displayed.

- a. On the legend, tap **Scale**.

The legend is expanded to display a list of ranges:

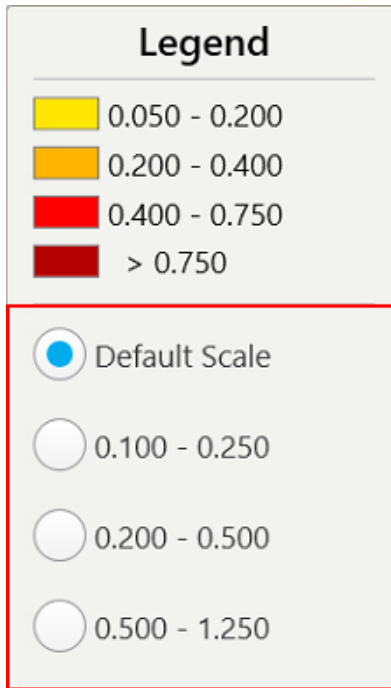



Figure 175: iTero TimeLapse scale options

- b. Select the required scale.

The changes are displayed according to the new scale.

5. If required, tap the Snapshot tool  to capture a screenshot of the images. For more information, see [Working with the Snapshot tool](#).
6. Tap  to exit the *iTero TimeLapse* window and then tap **Yes** to confirm exiting. The patient's profile page is displayed.

## 10.2 Invisalign Outcome Simulator Pro

Invisalign Outcome Simulator Pro is an advanced patient communication software tool that enables you to show patients the simulated outcome of their Invisalign treatment on an image of their own face. This tool provides additional information for the patient in their decision to begin Invisalign treatment.

### Notes:

- The Invisalign Outcome Simulator Pro simulation is available only for **Study Model/iRecord** procedures and **Invisalign Aligners** procedure types, and is automatically triggered when sending the scan.
- Invisalign Outcome Simulator Pro requires pairing your Invisalign Doctor Site account with your iTero account. For more information, contact iTero Customer Support.



Once the simulation is complete, you can tap  in the Viewer or the **Invisalign Outcome Simulator Pro** button in the *Orders* page, as described in [Working with orders](#).

For more information on using Invisalign Outcome Simulator Pro, refer to the Invisalign Outcome Simulator Pro documentation.

## 10.3 Invisalign Outcome Simulator

Invisalign Outcome Simulator is a software tool that enables you to show the patients the simulated outcome of their Invisalign treatment.

You can make real-time adjustments to the simulated outcome while showing the patient. This tool provides additional information for the patient in their decision to accept treatment.

To open the Invisalign Outcome Simulator tool, after sending the scan, tap **Invisalign Outcome Simulator** in the *Orders* page, as described in [Working with orders](#), or in the patient's profile page, as described in [Viewing the patient details](#).

For more information on the Invisalign Outcome Simulator tool, refer to the *Invisalign Outcome Simulator User Guide* <https://guides.itero.com>.

## 10.4 Invisalign Progress Assessment

The Progress Assessment tool includes a report that is a color-coded tooth movement table to assist the user in making treatment decisions to track the patient's progress in their ClinCheck treatment plan.

To open the Invisalign Progress Assessment tool, after sending the scan, tap **Invisalign Progress Assessment** in the *Orders* page, as described in [Working with orders](#).

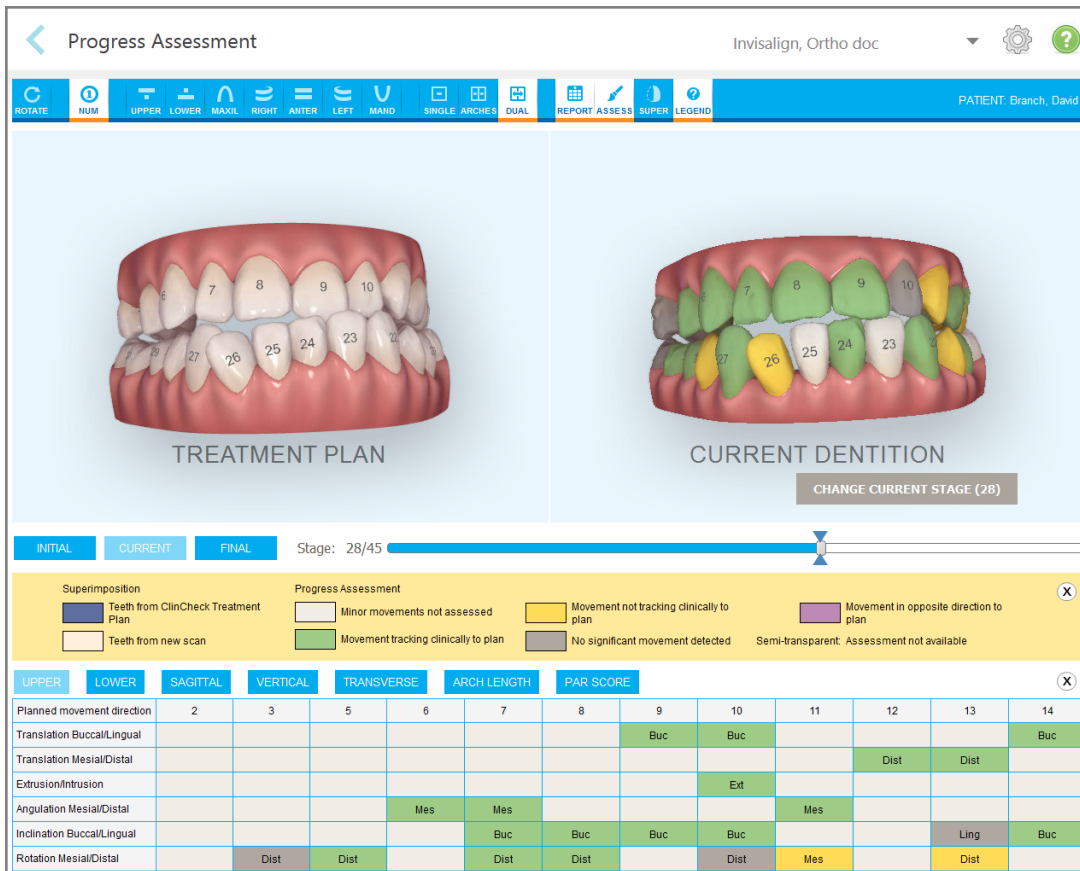

Figure 176: Progress Assessment window

For more information regarding the Invisalign Progress Assessment tool, refer to the **Progress Assessment** section in the *Invisalign Outcome Simulator User Guide* <https://guides.itero.com>.

### 10.5 Invisalign Go system

Invisalign Go is a low-stage aligner product that helps you assess and treat patients in just a few taps, with guidance every step of the way.

For more information regarding the Invisalign Go System, refer to the Invisalign documentation.

## 10.6 Editing tools

After you have scanned the model, you can edit it using the following tools:

- Delete segment tool, described in [Deleting a segment](#)
- Trim tool, described in [Working with the Trim tool](#)
- Eraser tool, described in [Working with the Eraser tool](#)
- Disable auto-cleanup tool, described in [Disabling auto-cleanup](#)
- Enable Saliva Detection tool, described in [Enabling saliva detection](#)

**Note:** When disabling auto-cleanup or enabling saliva detection, you should select the tool immediately after starting the scan. The tool is activated from that point on.

The editing tools are accessed by pressing on the screen.

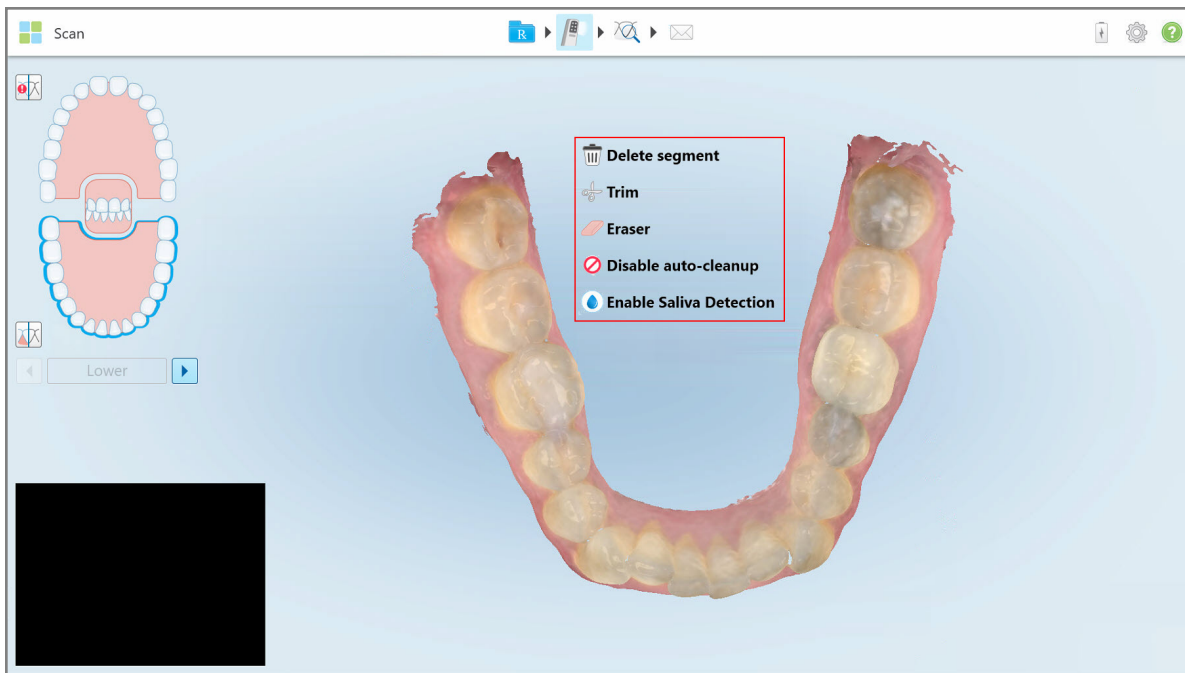

Figure 177: Editing tools

### 10.6.1 Deleting a segment

The Delete segment tool enables you to delete the entire scanned segment.

**To delete the segment:**

1. Press the screen to display the editing tools.

2. Tap the **Delete segment** tool .

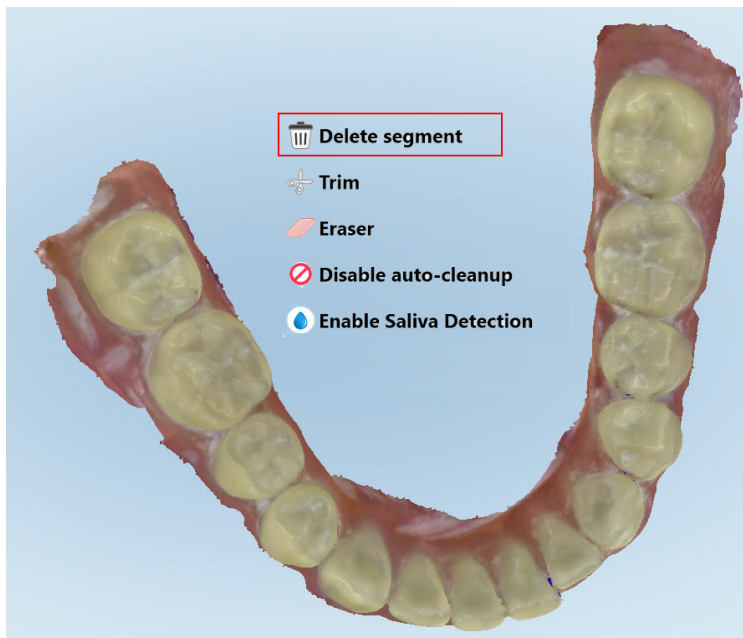

Figure 178: Delete segment tool

A confirmation message is displayed.

3. Tap **OK** to confirm the deletion.  
The entire scanned segment is deleted.

## 10.6.2 Working with the Trim tool

The **Trim** tool  enables you to trim away excess soft tissue such as cheek or lip artifacts from the scan. This tool is available for Orthodontic procedures only.

The Trim tool can be accessed from the *Scan* window or the *View* window.

### To trim the excess material:

1. In the *Scan* window, press the screen to display the editing tools and then tap the **Trim** tool .

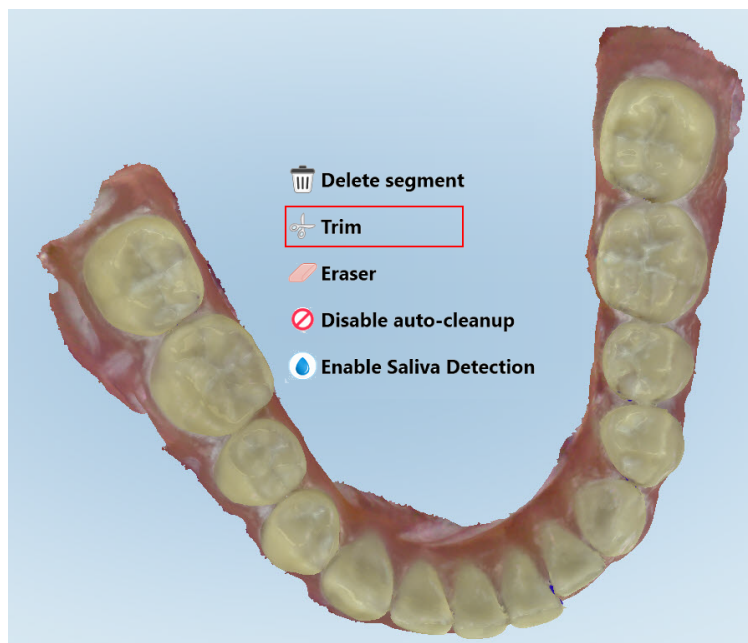



Figure 179: Trim tool from the Scan window

Or

In the *View* window, tap the Trim tool .

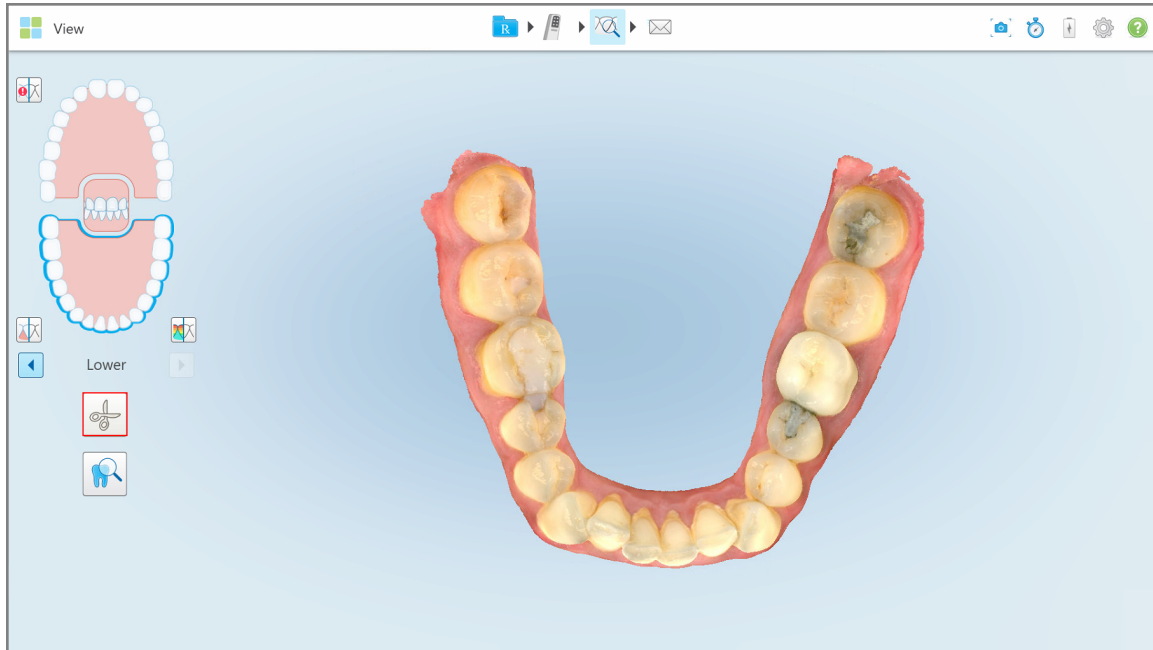

Figure 180: Trim tool from the *View* window

The Trim tool expands to show the following options:



Figure 181: Trim tool options

2. With your finger, mark the area you would like to trim away.

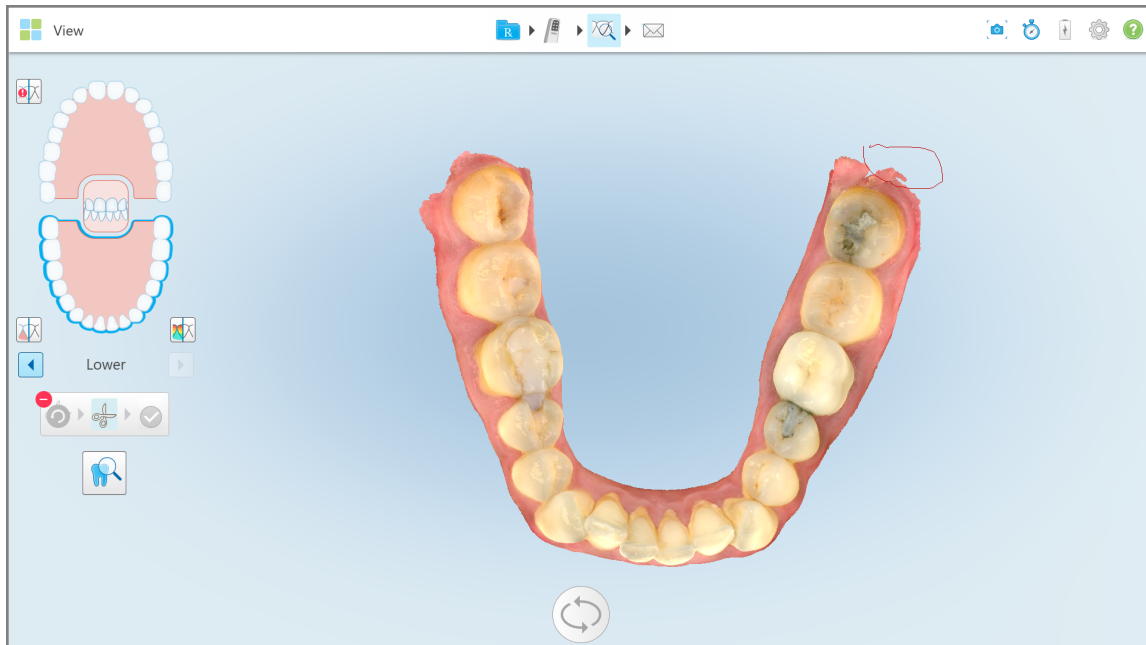

Figure 182: Mark the area to be trimmed away

The area to be trimmed away is highlighted and the confirmation icon is enabled.

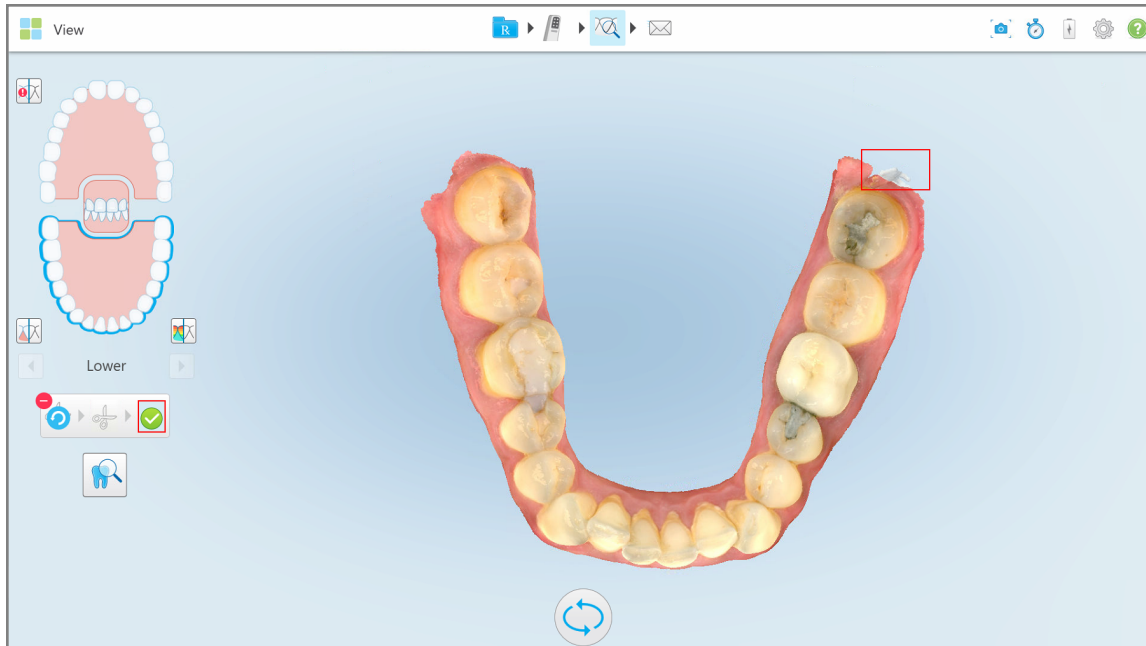



Figure 183: Selected area is highlighted, and the confirmation icon is enabled

3. If required, you can tap  to undo the trimming.
4. Tap  to confirm the trimming.  
The selected area is removed.

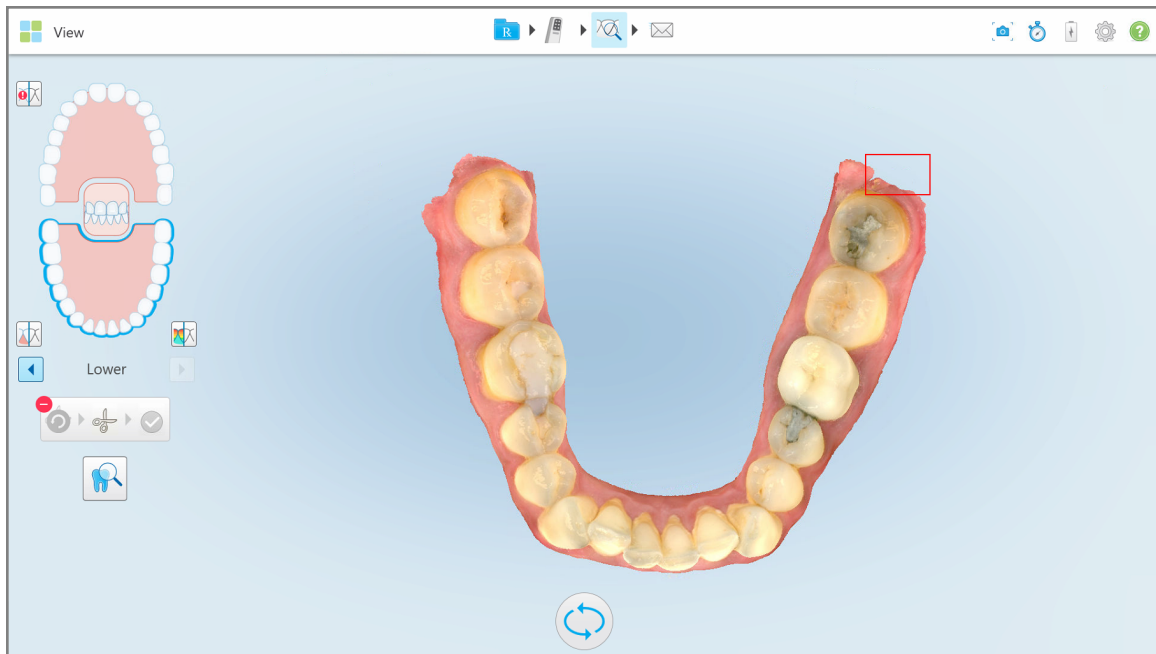



Figure 184: Selected area has been removed

### 10.6.3 Working with the Eraser tool

The Eraser tool  enables you to erase a selected area of the scanned model and then rescan only the erased area.

For example:

- You can remove moisture and artifacts, such as blood or saliva, that are covering the margin.
- If there are areas of red on the Occlusal Clearance legend after post-processing (*View* mode), you can reduce the relevant tooth, return to *Scan* mode to erase the area on the model, and then rescan it.

**To erase part of the scan:**

1. In the *Scan* window, press the screen to display the editing tools.
2. Tap the Eraser tool .

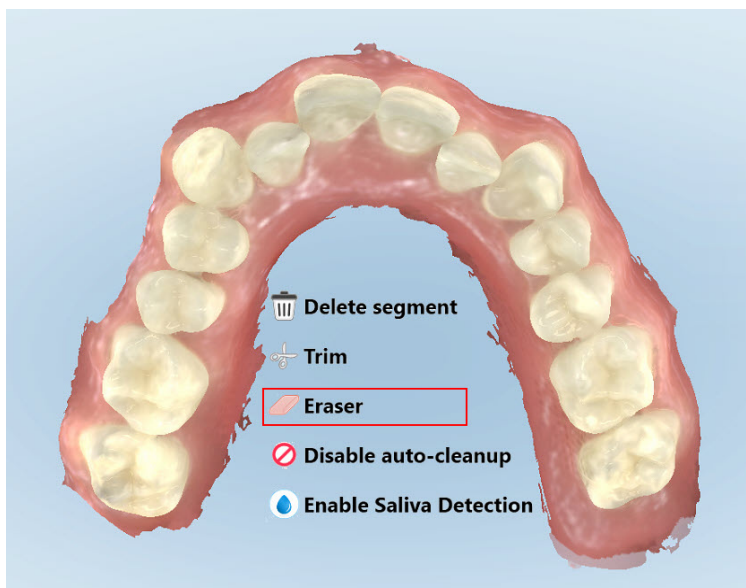
**Figure 185: Eraser tool**

3. With your finger, mark the area to be modified.

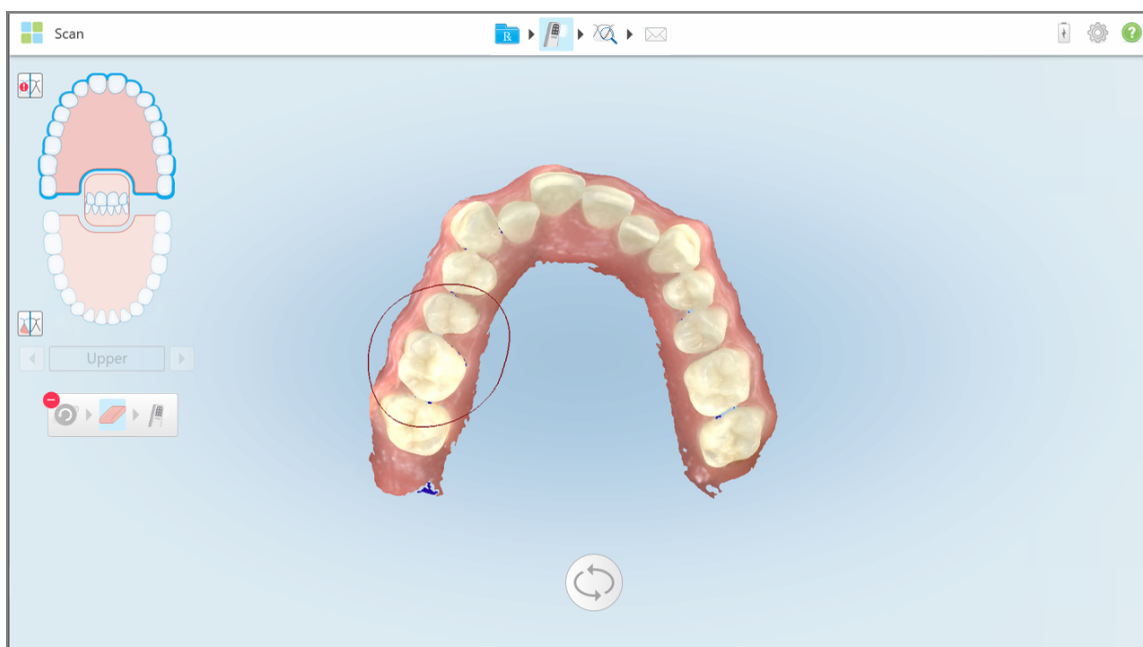
**Figure 186: Mark the area to be modified**

As soon as you lift your finger, the selected area is removed, and the scan tool  is enabled.

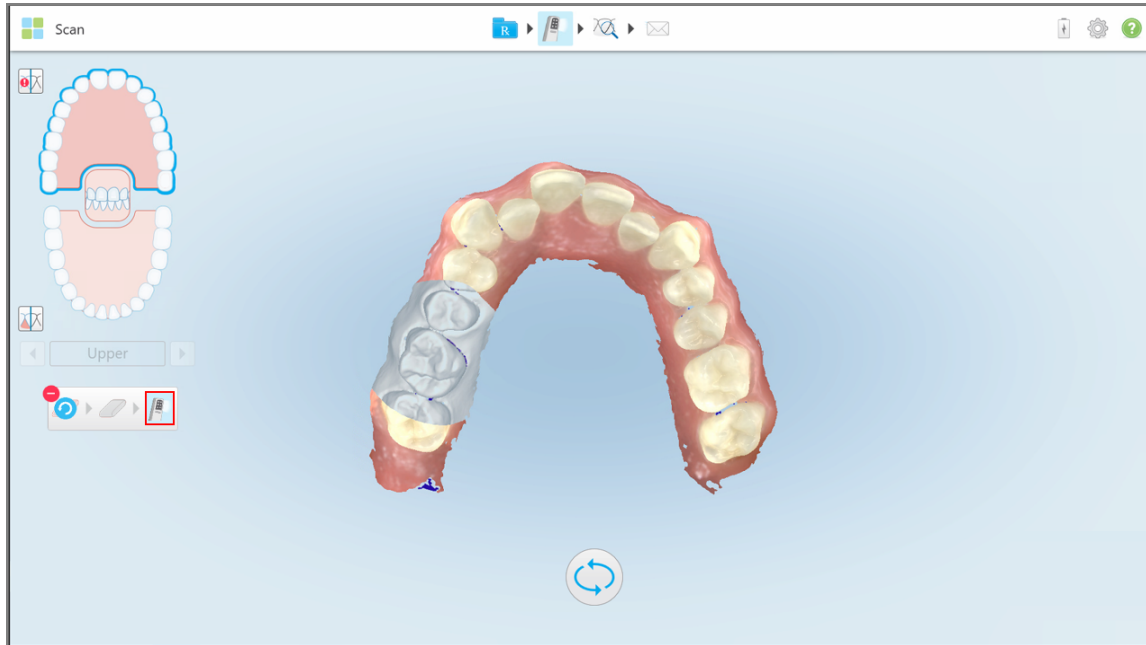



Figure 187: Selected area removed, and scan tool enabled

4. If required, tap  to undo the deletion.
5. Tap  to return to Scan mode and rescan the deleted area.

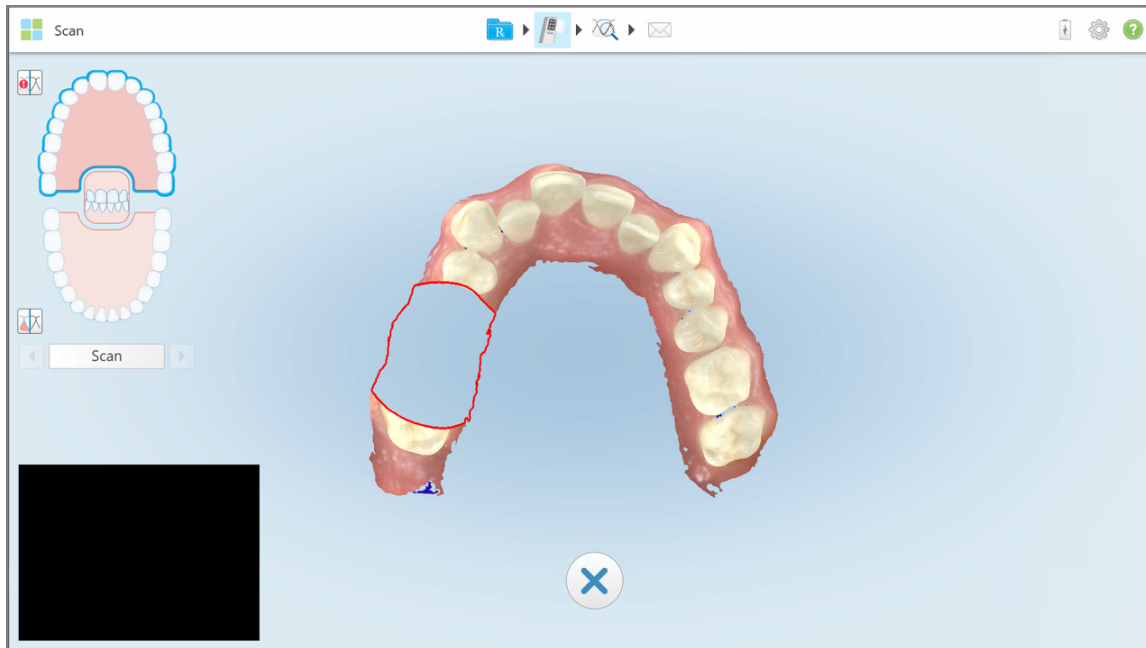

Figure 188: Deleted area to be rescanned

#### 10.6.4 Disabling auto-cleanup

By default, excess tissue is removed from around the edges of the 3D model during scanning. If required, you can turn off this functionality for the current scan.

##### Notes:

- This tool is not supported for edentulous gums.
- Disabling auto-cleanup is relevant only from the point at which this feature is disabled and only for the current scan session. Excess material will be removed by default in the next scan.

##### To disable auto-cleanup:

1. Start scanning, pause the scan, and then press the screen to display the editing options.

2. Tap the **Disable auto-cleanup** tool .

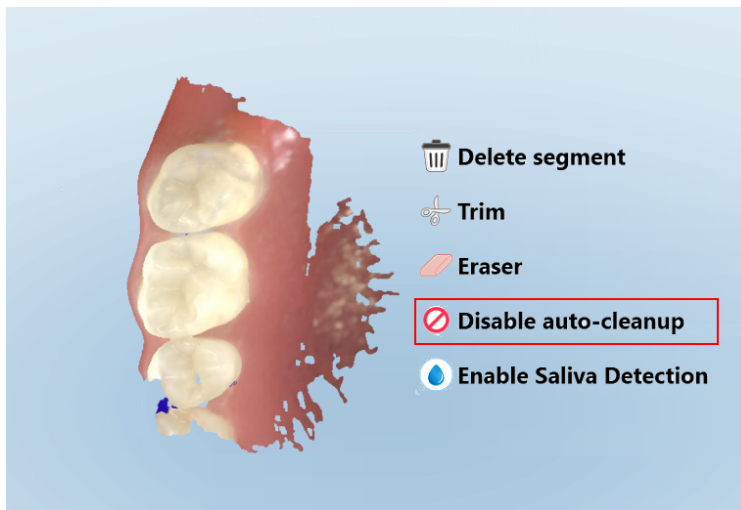

Figure 189: Disable auto-cleanup tool

3. Continue scanning the arch.  
The scan is displayed with the excess material showing.

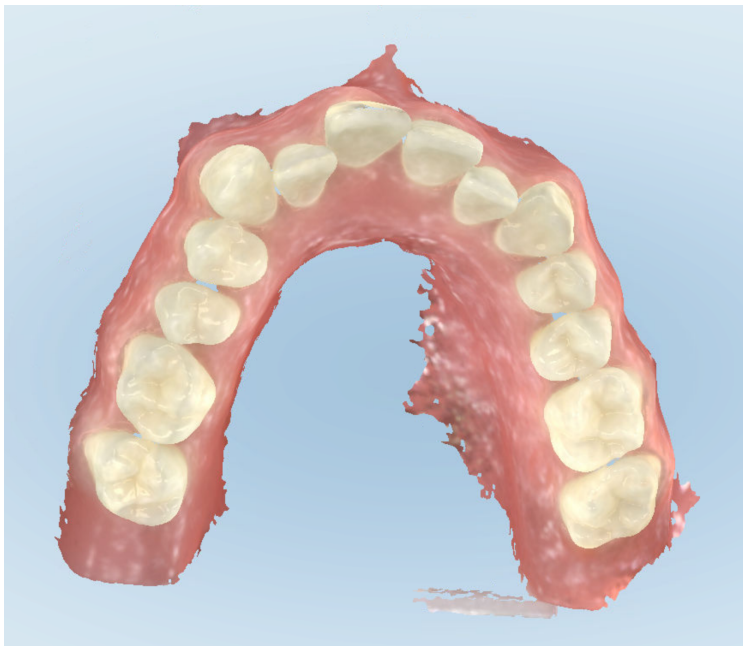

Figure 190: Scan displayed with excess material showing

4. To return to scanning without excess tissue, press the screen to display the editing options and then tap **Enable auto-cleanup**. From this point on, scanned excess tissue is removed from the model.

### 10.6.5 Enabling saliva detection

You can enable saliva detection while scanning, applicable only from the point at which this feature is enabled and only for the current scan session. You will not be notified regarding saliva detection in the next scan.

If required, you can enable saliva detection for all scans by default, as described in [Defining the scan settings](#).

**To enable saliva detection while scanning:**

1. In the *Scan* window, pause the scan, and then press the screen to display the editing tools.
2. Tap the **Enable Saliva Detection** tool .

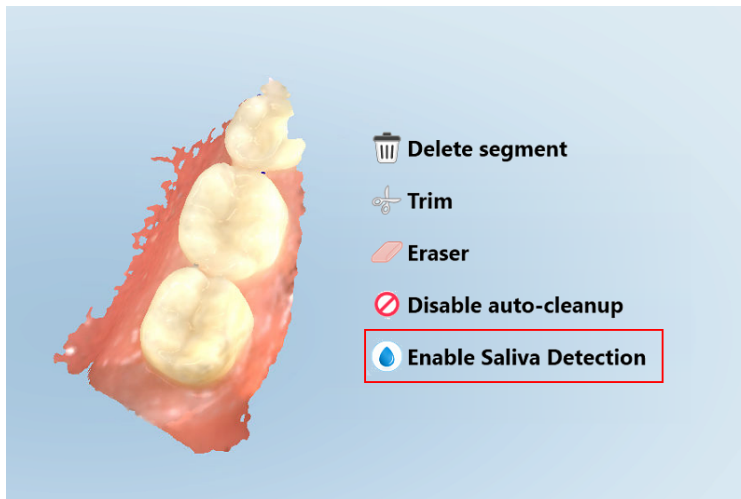



Figure 191: Enable Saliva Detection tool

From this point on during the scan, whenever saliva is detected, a drop icon is displayed on the screen and holes are displayed on the 3D model in the areas where the saliva was detected.

## 10.7 Working with the Occlusal Clearance tool

The Occlusal Clearance tool  enables you to view the contact and distance between the opposing teeth, for example, to ensure that the prepped tooth has sufficient reduction for the material chosen in the Rx.

The Occlusal Clearance tool can be accessed while in View mode and from the Viewer.

**Note:** The Occlusal Clearance tool is displayed only after you have scanned the upper and lower jaws, and the bite.

To display the occlusal clearance while in View mode:

1. In the *View* window, tap the Occlusal Clearance tool .

The occlusal clearance between the opposing teeth is displayed.

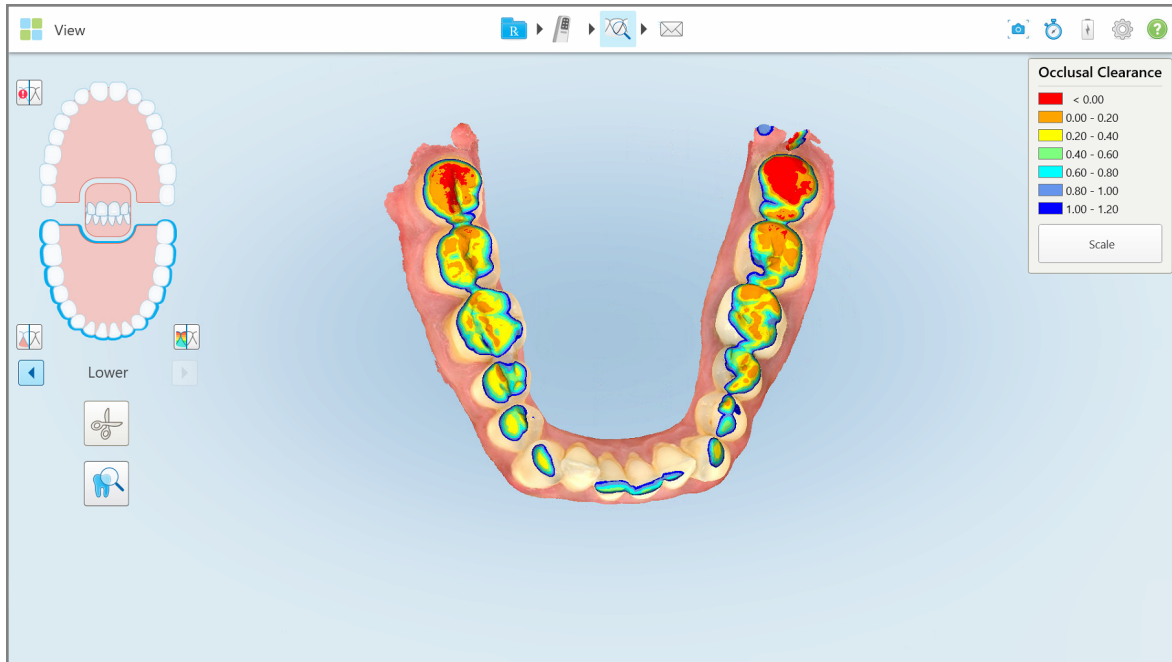

Figure 192: Occlusal clearance between the opposing teeth

2. If necessary, reduce the prepped tooth, erase the relevant section from the model, and rescan the area, as described in [Working with the Eraser tool](#).
3. If required, you can change the occlusal values displayed on the opposing teeth.

- a. On the legend, tap **Scale**.

The legend is expanded to display a list of range options.



Figure 193: Occlusal Clearance range options

- b. Select the required scale.
  - c. The occlusal clearance is displayed according to the new scale.
4. If required, tap  to take a screenshot of the occlusal clearance. For more information on capturing screenshots and adding annotations, see [Working with the Snapshot tool](#).

#### To display the occlusal clearance from the Viewer:

1. Open the past order of a specific patient in the *Orders* page, or from a specific patient's profile page, tap **Viewer** to display the Viewer.



2. In the Viewer, tap .
3. Select the arch for which to display the occlusal clearance.

The clearance between the opposing teeth is displayed, as well as a legend displaying the scale.

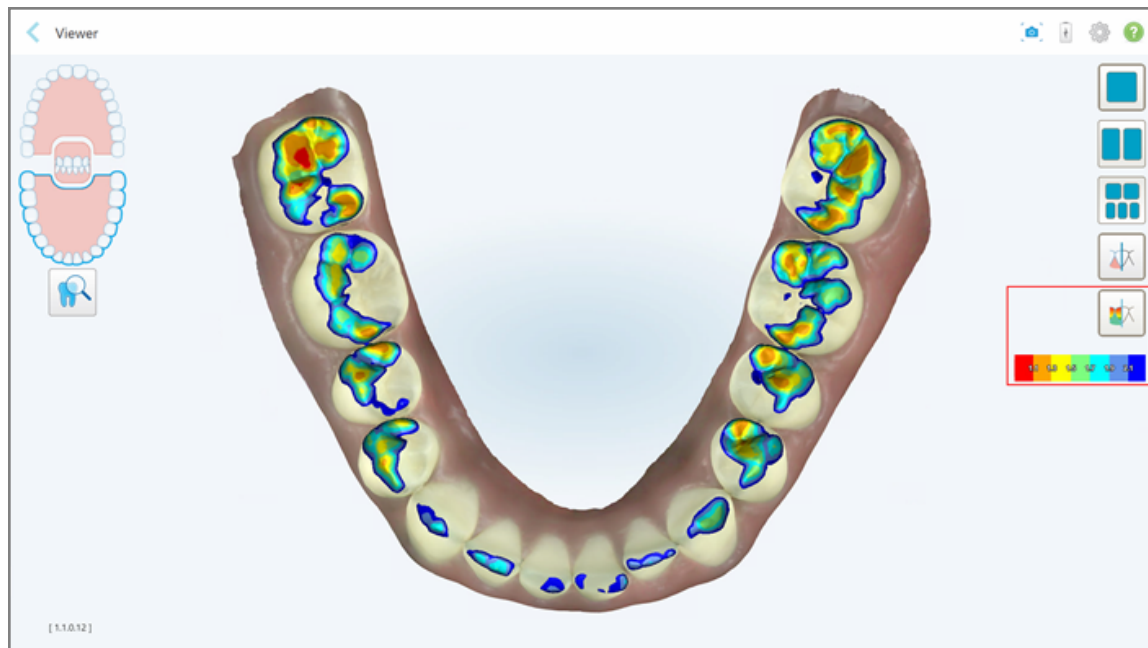



Figure 194: Occlusal Clearance tool and legend displayed in the Viewer

4. If required, tap  to take a screenshot of the occlusal clearance. For more information on capturing screenshots and adding annotations, see [Working with the Snapshot tool](#).

## 10.8 Working with the Die Separation tool

The die separation is created automatically, according to the position of the green hint point, which must be located on the center of the prepped tooth after scanning.

If required, the die separation area can be edited or created manually.

### To display the die separation:

1. After scanning the prepped tooth, ensure that the green hint point is centered on the prepped tooth. Move it manually, if required.

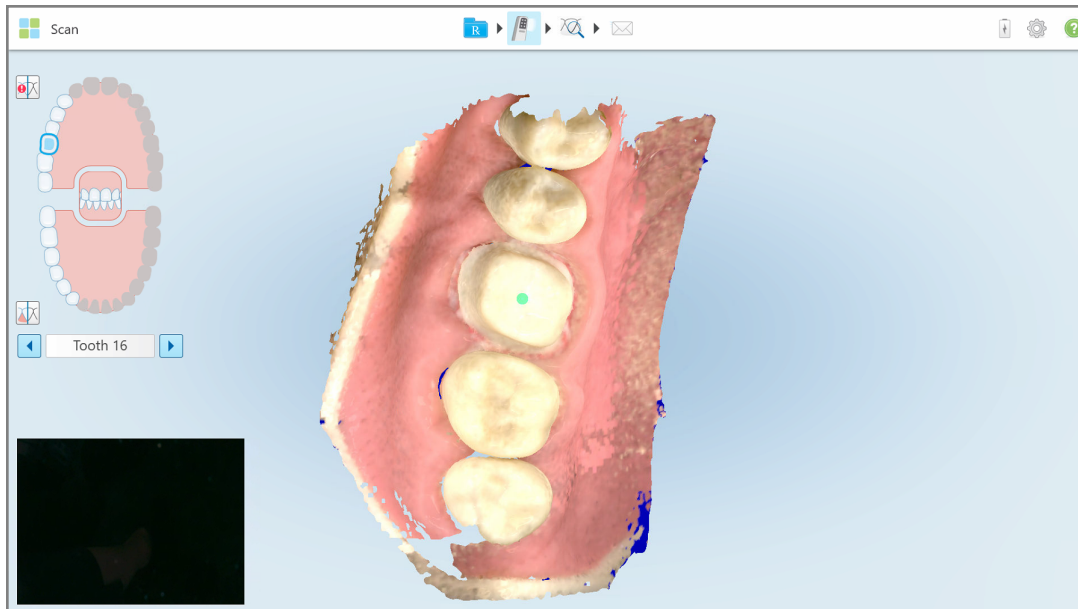





Figure 195: Green hint point centered on the prepped tooth

2. Tap  on the toolbar to move to **View** mode.
3. In the *View* window, tap the Die Separation tool . The die separation is displayed in color in high resolution, and the complete 3D model in monochrome. You can switch between color and monochrome modes using the color toggle button .

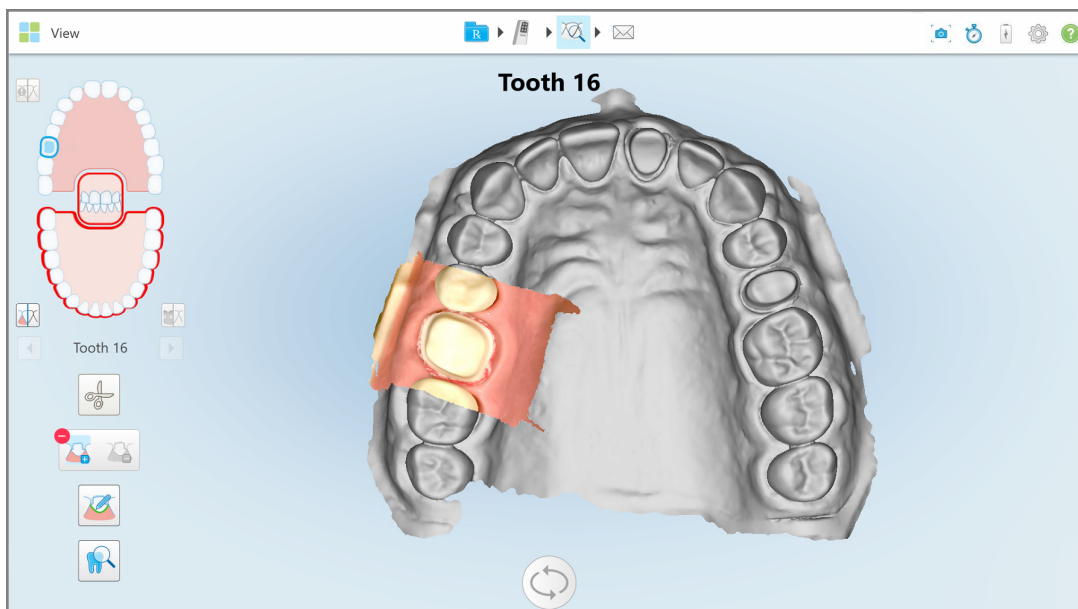



Figure 196: Die separation is displayed in high resolution



**To create the die separation manually:**

1. In the *View* window, tap the Die Separation tool .

The tool expands to show the following options:



Figure 197: Die Separation tool options

2. Tap  and mark the whole arch segment with your finger.
3. Tap  to mark the prepped tooth in high resolution.

The model is displayed in monochrome, as follows:

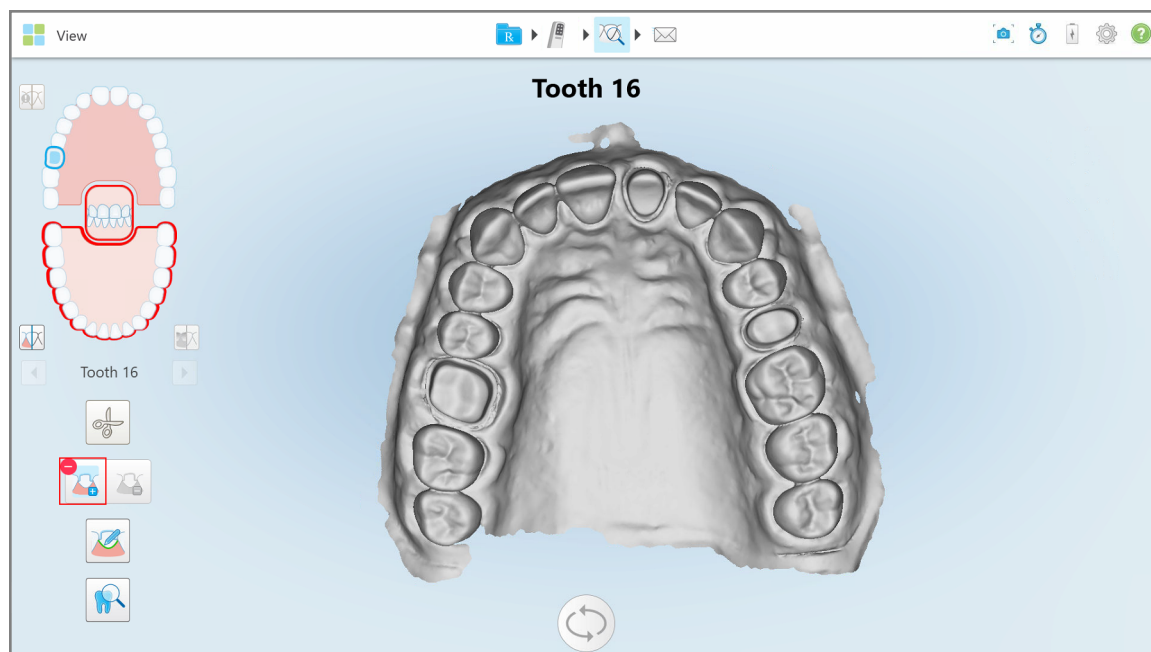

Figure 198: Before selecting the die separation

4. Draw the area for the die separation.

The selected area is displayed in high resolution.

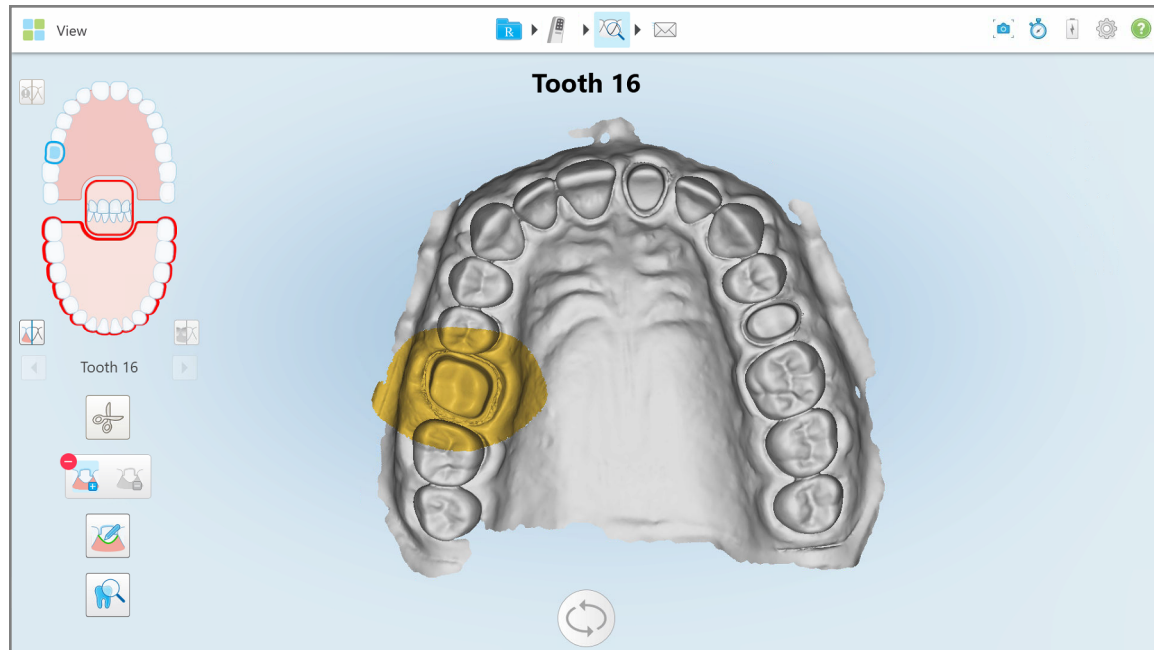

Figure 199: Prepped tooth is displayed in high resolution

## 10.9 Working with the Margin Line tool



The Margin Line tool automatically detects and marks the margin line on Fixed Restorative procedures that require crowns. If required, it can be marked manually for other indications. Once the margin line has been created, you can tweak it or recreate it if it has been deleted.

### 10.9.1 Automatically defining the margin line

The Margin Line tool automatically detects and marks the margin line on Fixed Restorative procedures that require crowns.

**Note:** The margin line may not be created automatically if:

- The prepped tooth was not scanned properly.
- The wrong die separation was used – the green dot was not centered on the prepped tooth while scanning – therefore part of the scan is not within the die separation area.

If the margin line cannot be created automatically, you will receive a message notifying you of this, and you can manually define the margin line, as described in [Manually defining the margin line](#).

**To define the margin line automatically:**

1. In the *View* window, tap the prepped tooth in the navigation controls.

The 3D model display moves to the occlusal view and zooms in on the prepped tooth.

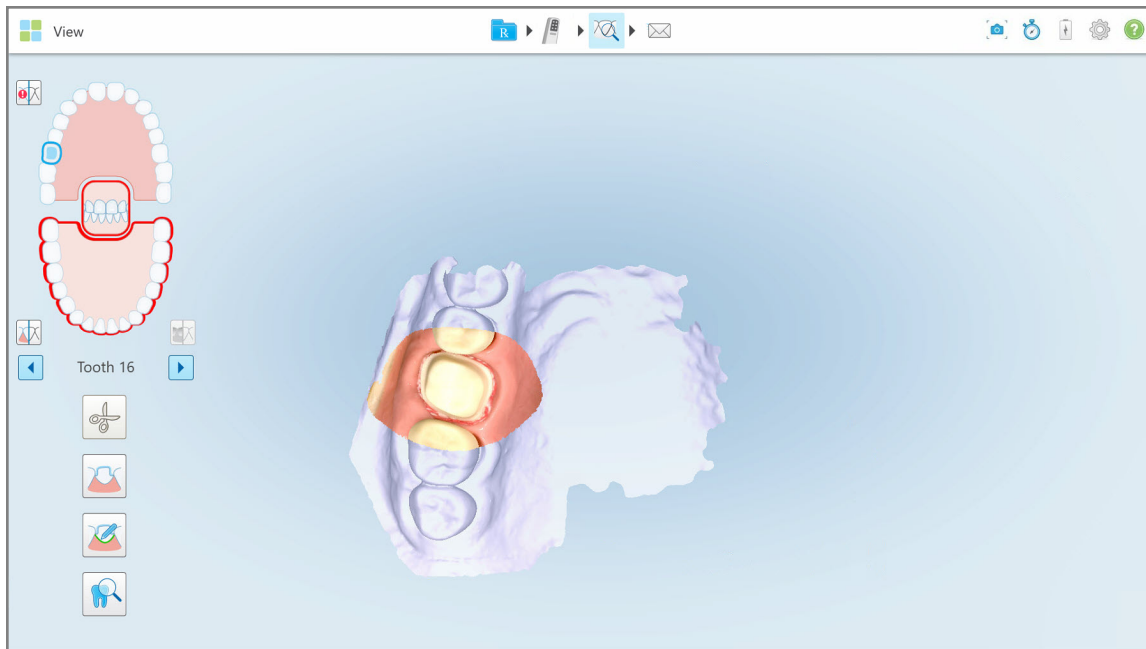

Figure 200: Model display moves to the occlusal view, and zooms in on the prepped tooth

2. Tap the Margin Line tool .

The Margin Line tool expands to show the following options:



Figure 201: Margin Line tool options

A message is displayed prompting you to wait while the automatic AI-based margin line is being detected. After a few seconds, the margin line is automatically marked on the prepped tooth. The teeth adjacent to the prepped tooth appear transparent, enabling you to see the edges of the margin line.

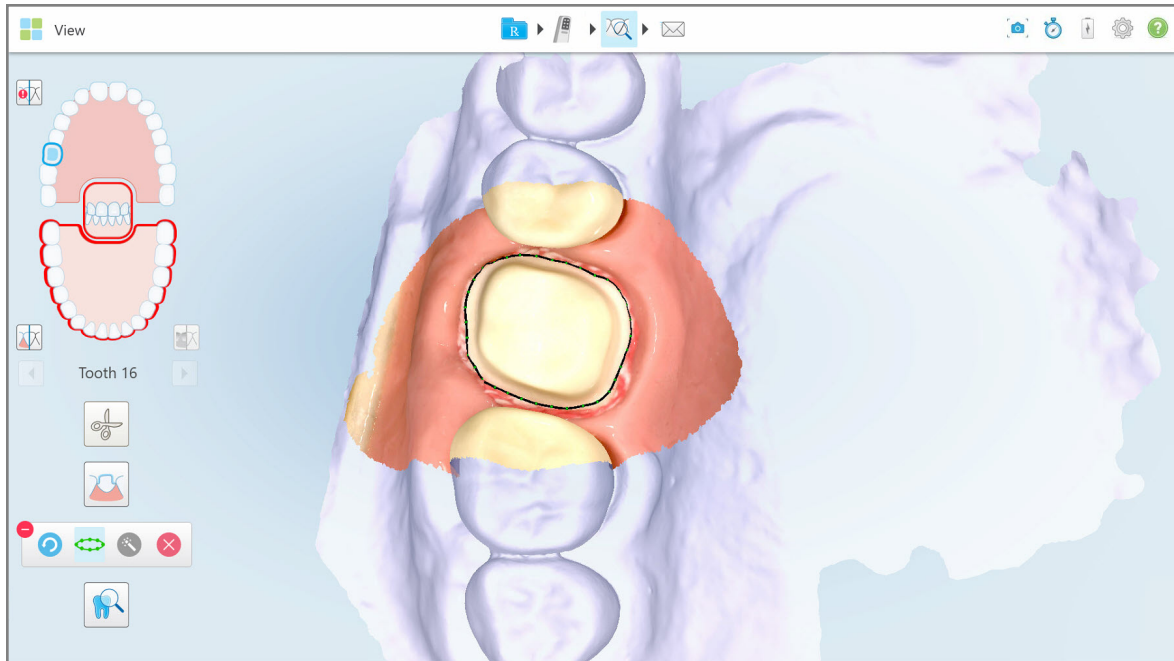





Figure 202: Margin line is marked on the prepped tooth

3. Tweak the margin line if required, by dragging any of the green control points.
4. If required, click  to undo the last action. You can click the button to undo the last 50 actions.
5. If required, click  to delete the margin line.
6. If required, click  to redisplay the deleted margin line.

### 10.9.2 Manually defining the margin line

If the margin line cannot be defined automatically, you can define it manually.

#### To define the margin line manually:

1. In the *View* window, tap the prepped tooth in the navigation controls.  
The 3D model display moves to the occlusal view and zooms in on the prepped tooth.

2. Tap the Margin Line tool .

The Margin Line tool expands to show the following options:



Figure 203: Margin Line tool options

3. Tap  and then tap around the prepped tooth to draw a point-by-point line of at least 6–8 points.

**Note:** Make sure to close the margin line. If you do not complete the margin line and try sending the scan, you will receive a notification that the partial margin line will be deleted. You can go back and complete the margin line.

## 10.10 Working with the Review tool

The View mode includes a **Review tool** that enables you to view the colored intraoral images captured during the scan, for every area of interest. These images are displayed in the image pane, on the right of the *View* window.

In addition, you can:

- Zoom in and out of the image in the image pane, as described in [Zooming in to and out of the images in the image pane](#)
- Adjust the brightness and contrast of the image in the image pane, as described in [Adjusting the brightness and contrast of images in the image pane](#)
- Capture screenshots of the image, as described in [Working with the Snapshot tool](#)

**To activate the Review tool:**

- In the View window, tap  and then drag the loupe from the right pane over an area of interest.

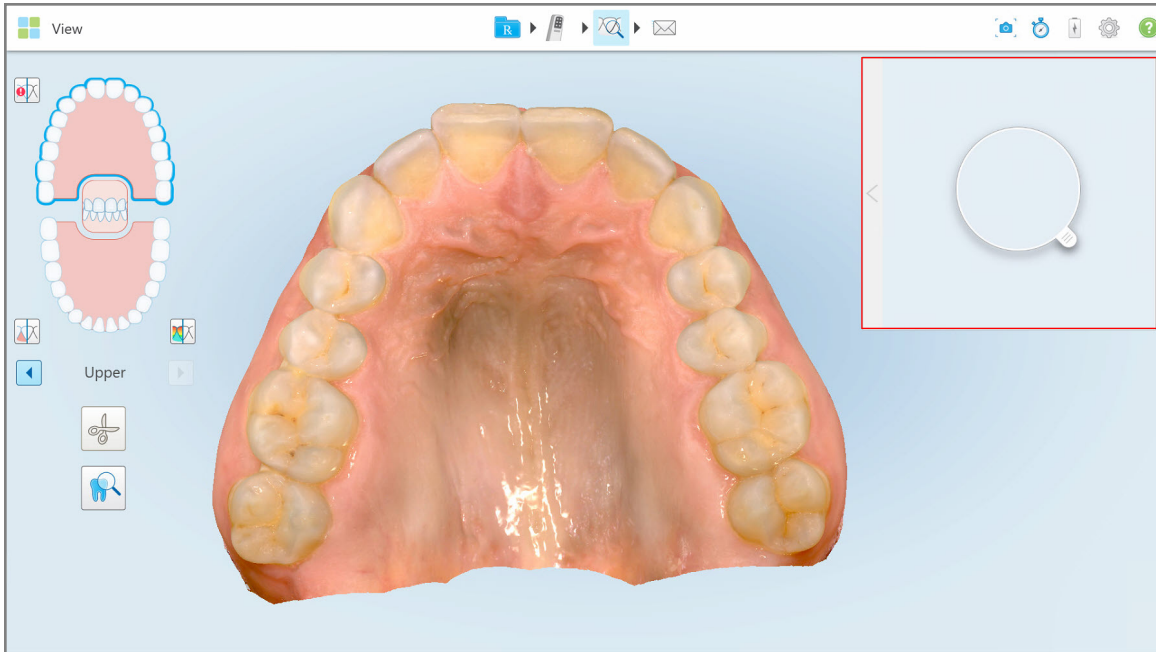

Figure 204: Review tool with the loupe in the right pane

The area within the loupe is displayed in the image pane on the right. The display in the image pane changes according to the position of the loupe.

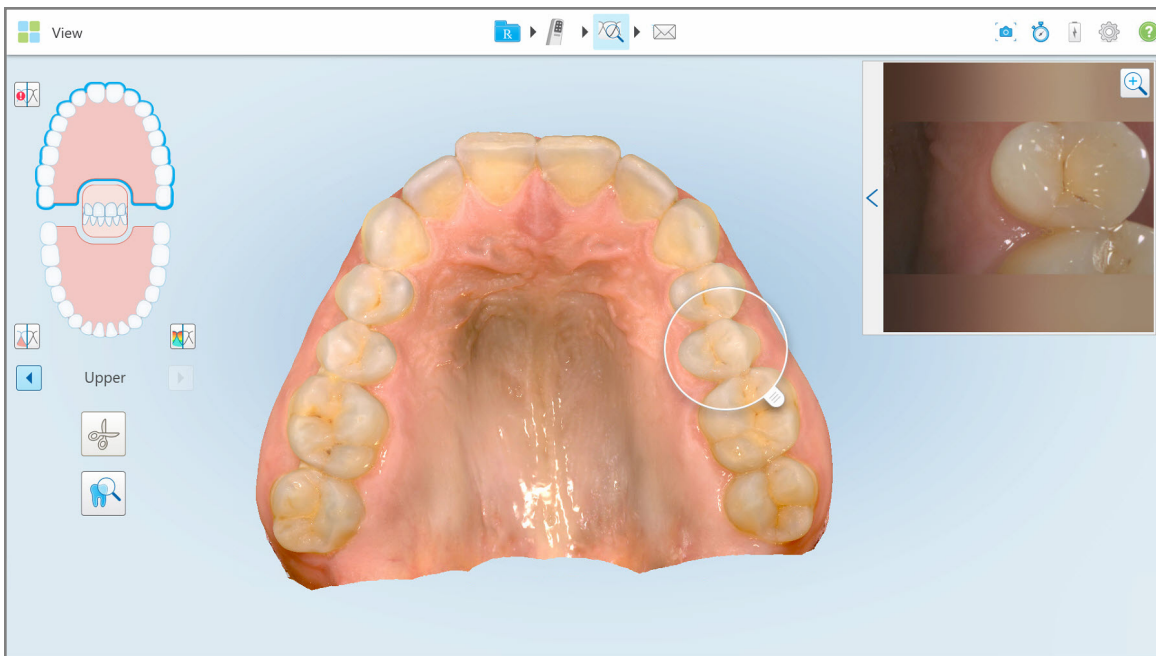

Figure 205: Image pane on the right showing the area of interest

### 10.10.1 Zooming in to and out of the images in the image pane

In order to better evaluate the scanned image in the image pane, you can zoom in to and out of the image, as well as adjust the contrast and brightness of the image.

You can zoom in to or out of the selected area of the image displayed in the image pane using the following methods:

- Using a spreading or pinching gesture on the image displayed in the image pane
- Double-tapping the image in the image pane to toggle zoom in/zoom out
- Tapping the zoom button displayed on the image

#### To zoom in or out using the zoom button:

1. Tap  on the colored intraoral image to zoom in to the area of interest.

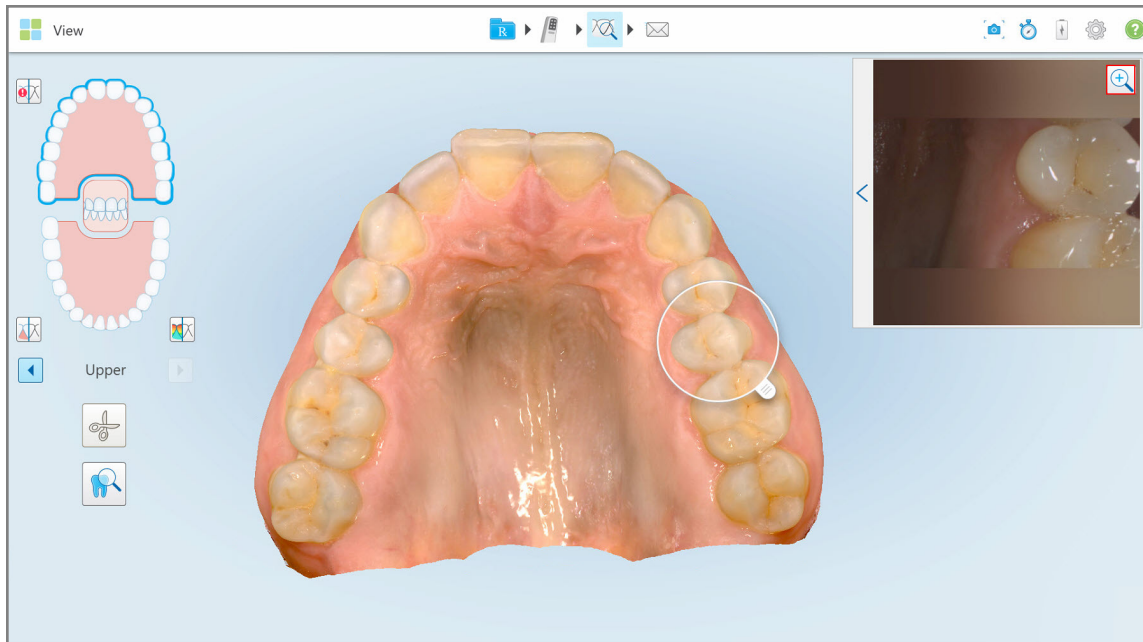

Figure 206: Zoom-in button on the image in the image pane

The image pane is enlarged to display the zoomed-in image.

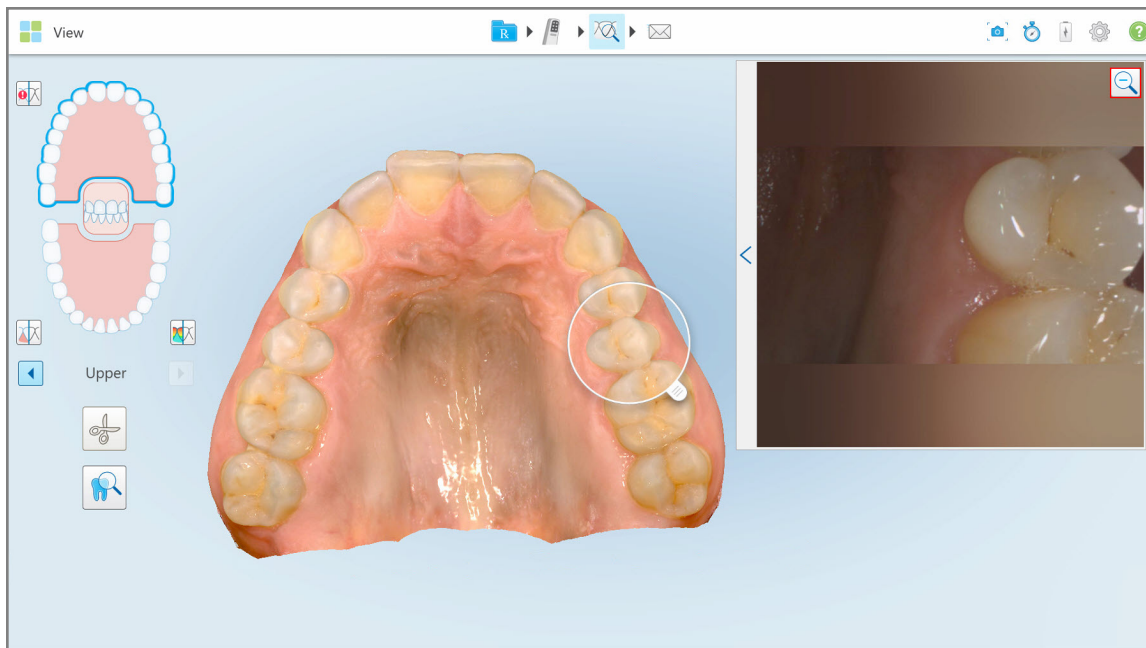



Figure 207: Zoomed-in image displayed in the enlarged image pane

2. Tap  on the enlarged 2D image to return the image to the default size.

### 10.10.2 Adjusting the brightness and contrast of images in the image pane

You can set the brightness and contrast of the images displayed in the image pane by adjusting the relevant sliders in the brightness and contrast toolbar.

- **Brightness** refers to the overall lightness or darkness of an image. Increasing the brightness makes every pixel in the image lighter, and vice versa.
- **Contrast** is the difference in **brightness** between objects in an image. Increasing the contrast makes light areas lighter and dark areas darker, and vice versa.

By default, the brightness and contrast toolbar is collapsed.

**Note:** The color and brightness controls are displayed only when an image is displayed in the image pane, and not when the loupe is in its default position in the right pane.

The contrast and brightness image controls are reset to their default values when selecting a different jaw, pushing the loupe back to its default position, or when exiting the tool.

To adjust the brightness and contrast of the images in the image pane:

1. Tap  on the left edge of the image pane to display the brightness and contrast adjustment toolbar.

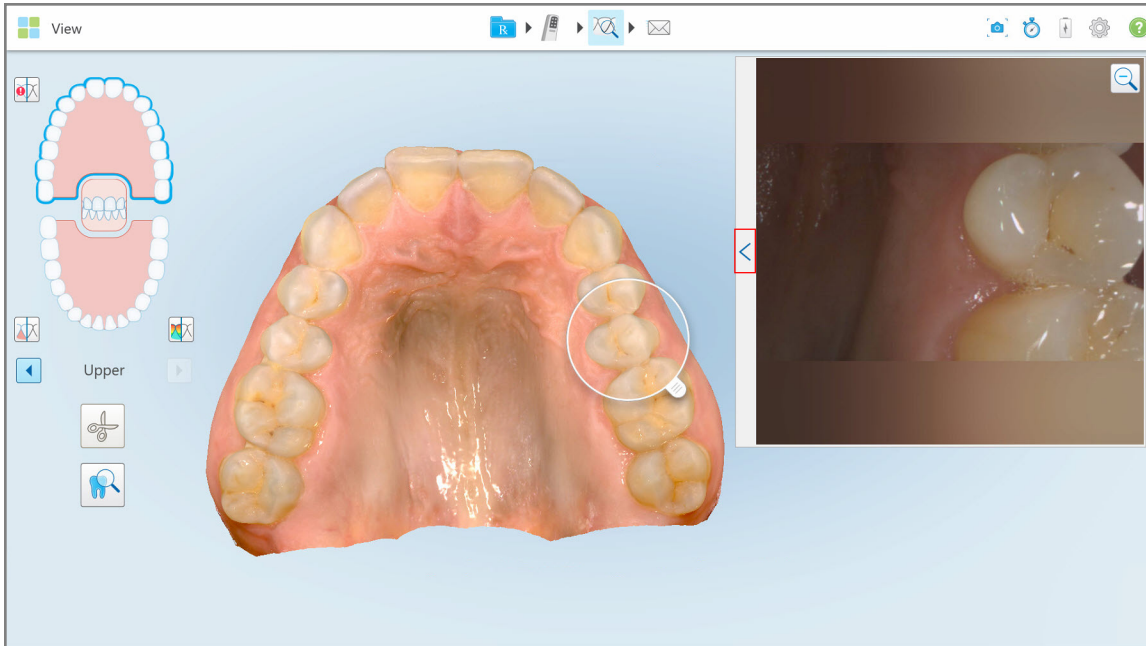

Figure 208: Brightness and contrast toolbar is collapsed

A brightness and contrast adjustment toolbar is displayed on the window in the image pane. By default, the brightness level is set to the lowest position and the contrast is set to the middle position.

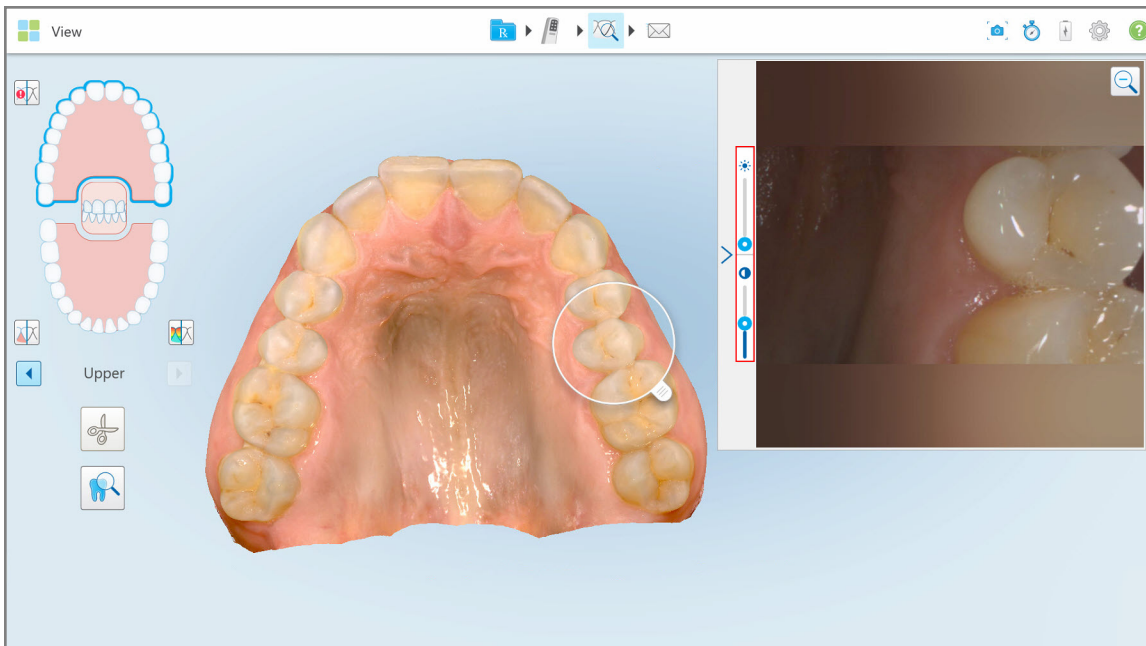

Figure 209: Brightness and contrast toolbar

2. Move the slider up or down to adjust the brightness  or contrast.

**Tip:** You can tap anywhere in the slider area and drag up or down to adjust the settings.

3. Tap  to collapse the toolbar.

### 10.10.3 Capturing the Review tool images

If required, you can capture the images displayed when using the Review tool. These images become part of the patient's export package and can later be downloaded from MyiTero.

For more information, see [Working with the Snapshot tool](#).

## 10.11 Working with the Snapshot tool

The Snapshot tool enables you to capture screenshots of the scanned model. These screenshots become part of the patient's export package and can later be downloaded from MyiTero. In addition, these screenshots can be added to the iTero Scan Report, created in MyiTero.

Once the image has been captured, you can add annotations, if required.

By default, each time you tap the Snapshot tool, the following images are captured and saved in a separate folder, whose name includes the Order ID, and date and time of the screenshots:

- Entire View window
- 3D image

If you are taking screenshots while using the Review tool, the following screenshots are included:

- Entire Review tool window, including 3D image and color viewfinder images
- 3D image
- 2D color viewfinder image (if the loupe has been dragged onto the 3D image)

Each set of screenshots is saved in a separate folder and saved in a folder with the patient's name, which can be downloaded from MyiTero as a zipped file.

Screenshots can be captured from any window that includes the Snapshot tool  on the scanner toolbar.

To capture a screenshot of a scanned image:

1. In **View** mode, tap the Snapshot tool  on the toolbar.

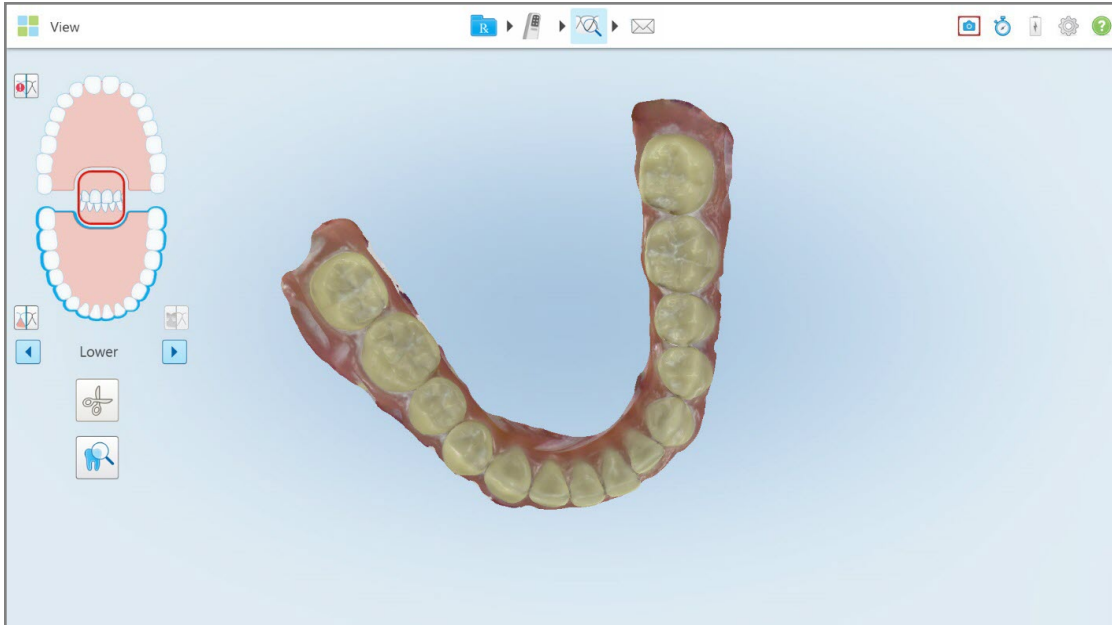

Figure 210: View mode – with Snapshot tool

The screen flashes, indicating that the screenshot was captured. A thumbnail of the screenshot is displayed on the bottom left of the window and remains for 7 seconds.

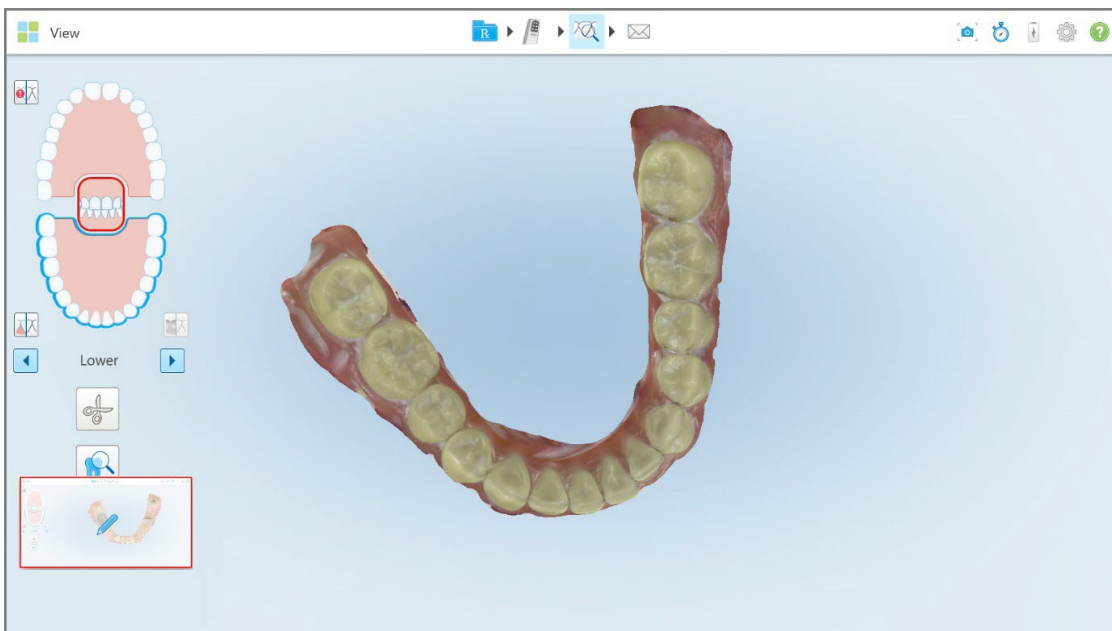

Figure 211: Screen capture thumbnail is displayed after taking a screen capture

2. Tap the thumbnail if you would like to add annotations to the screenshot.

The *Draw* window is displayed, showing a screenshot of the entire window, with an annotations toolbar on the top.

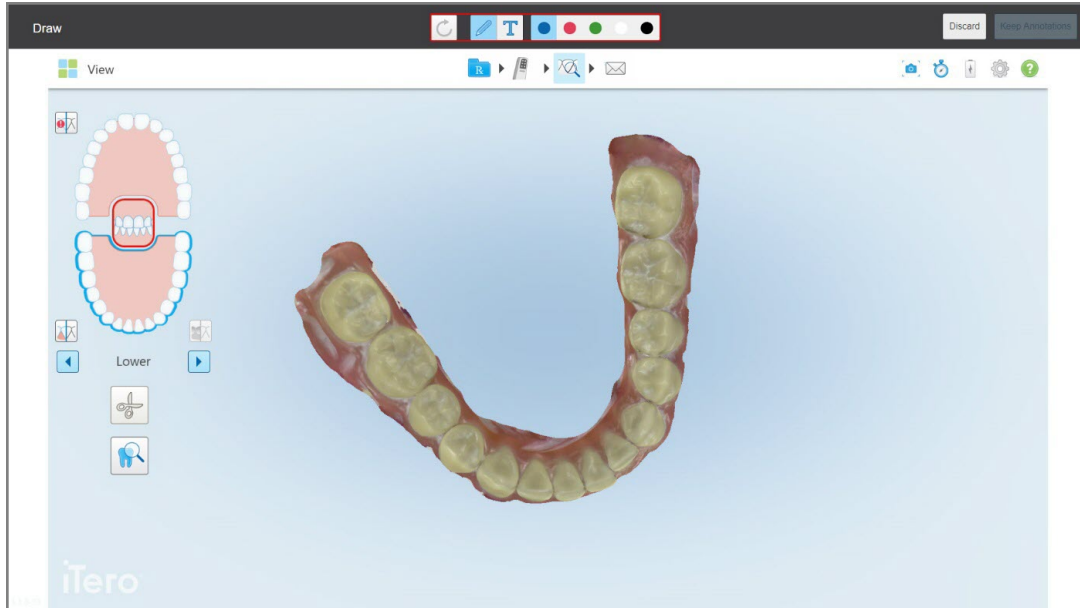







Figure 212: Screenshot with an annotations toolbar



Figure 213: Annotations toolbar

The annotations toolbar contains the following buttons:

- |   |   |
|---|---|
|  | Tap to undo previous annotations.   |
|  | Tap to draw on the screenshot.  |
|  | Tap to enter text on the screenshot.  |
|  | Tap the color for the drawing and text. By default, these will be the same color. |

3. Tap the required tool and color and then add your annotations. After adding text, tap  to save the text in the color selected.

**Note:** If you do not tap  after entering text, the color of the text will be changed if you select a different color for the next annotation.

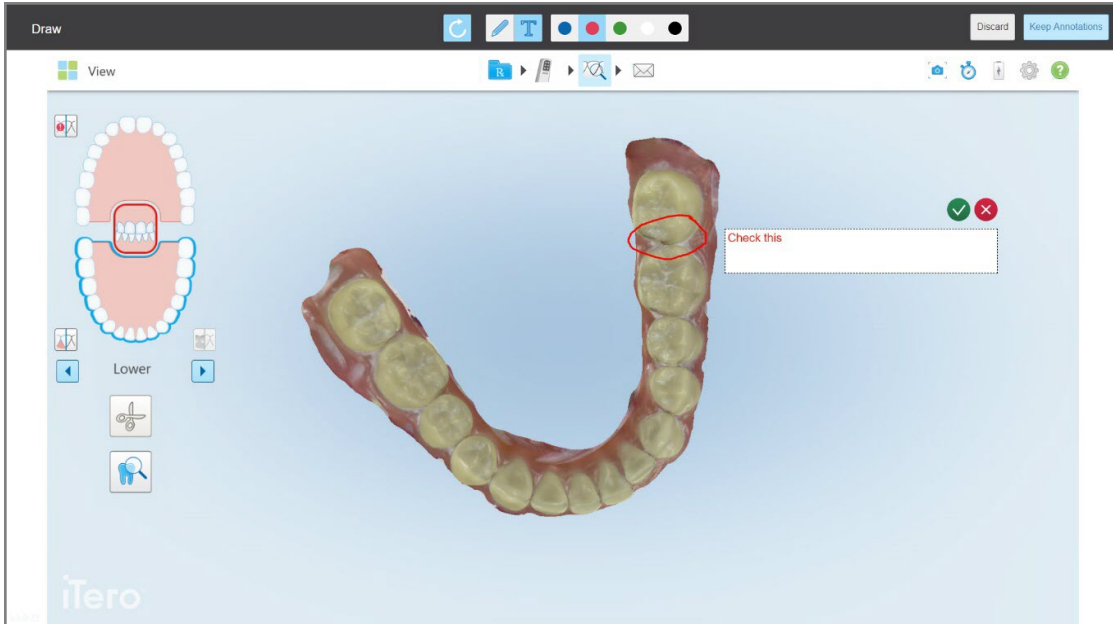

Figure 214: Adding text to the screenshot

4. To save the screenshot with the annotations, tap **Keep Annotations**.

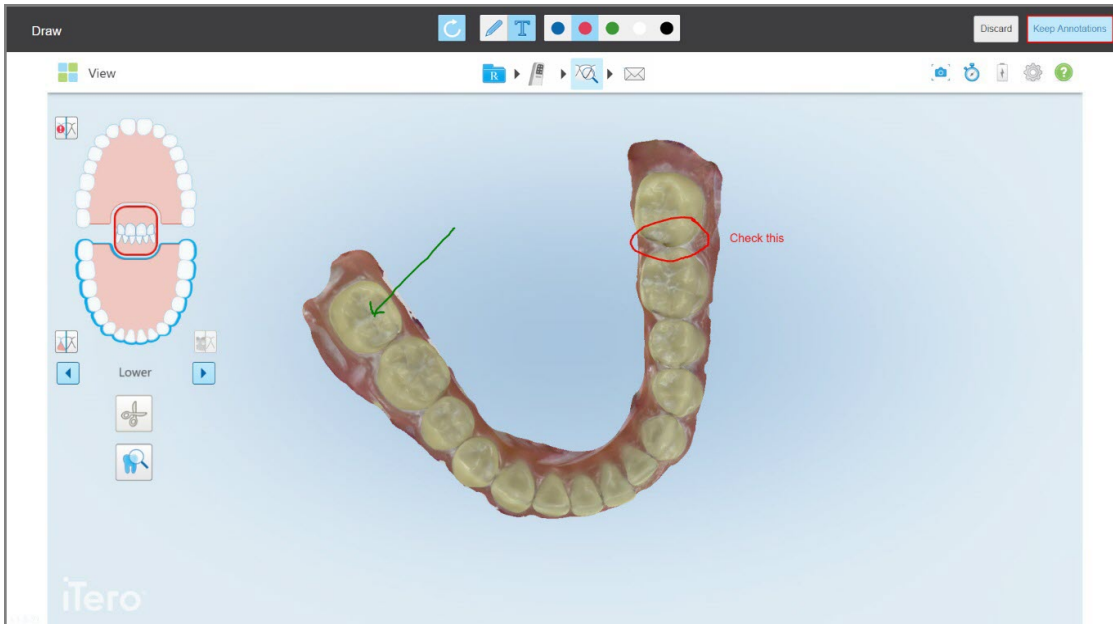

Figure 215: Screenshot with annotations

A pop-up message is displayed at the bottom of the screen, notifying you that the screenshots and annotations will be uploaded to MyiTero, where you can access them.

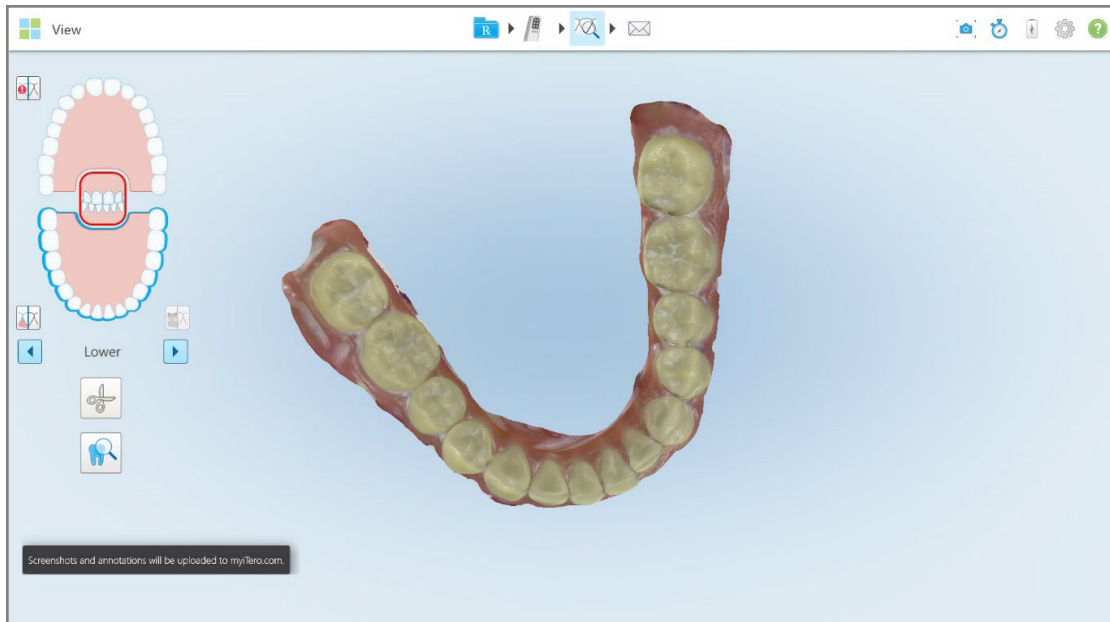

Figure 216: Notification that the screenshots and annotations will be uploaded to MyiTero

5. To save only the screenshots without the annotations, tap **Discard**.

A confirmation message is displayed.

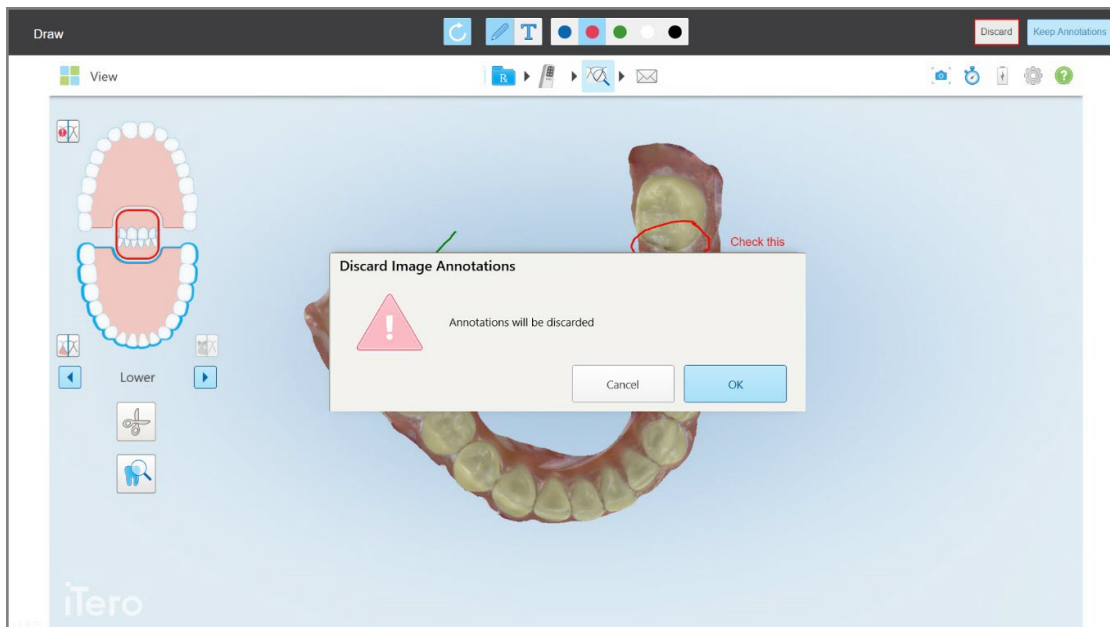

Figure 217: Confirmation about the annotations being discarded

a. Tap **OK** to proceed.

A pop-up message is displayed notifying you that the screenshots will be uploaded to MyiTero.

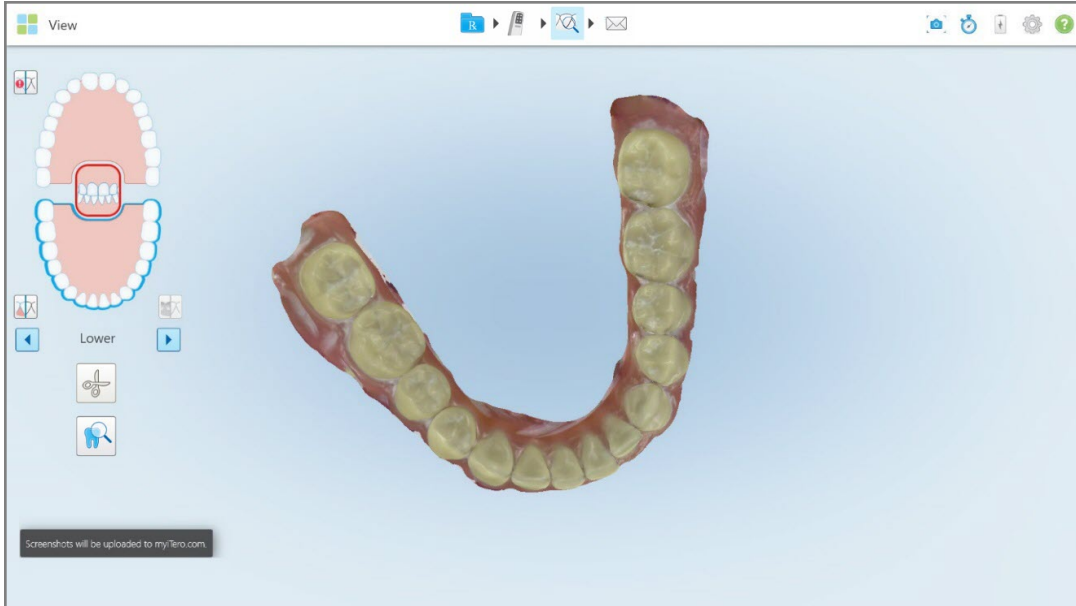

Figure 218: Notification that the screenshots will be uploaded to MyiTero

The screenshots can now be downloaded from MyiTero, from the *Orders* page, or from the *Viewer*.

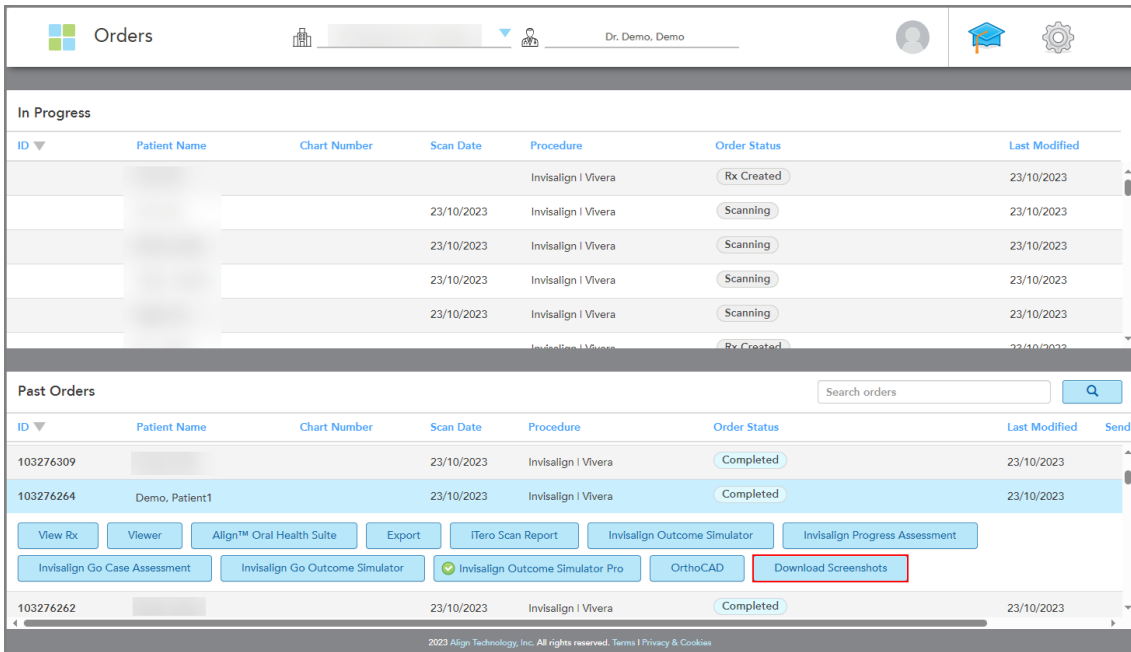

Figure 219: Option to download screenshots from the Orders page in MyiTero

## 11 Care and maintenance

Align scanners do not require specific maintenance. During the service lifetime, support including replacement of malfunctioning main system components, or software maintenance including software upgrades to improve the user's experience might be performed, in accordance with the service contract.

Before cleaning and disinfecting the scanner, read and understand the **Cleaning and Disinfection** section in the [Safety instructions](#).

**Note for users in Australia:** This document refers to Caviwipes1 and their designated contact time of one (1) minute as the default instruction for the cleaning and disinfection procedure. For a list of alternative active ingredients approved in Australia, see [Approved cleaning and disinfection materials \(Australia only\)](#). When following the cleaning and disinfection procedure detailed in this manual, please refer to the manufacturers' instructions and specified contact time for the selected disinfecting wipes.

If you are performing any sanitation procedures in the office that involve fogging or spraying, make sure that the iTero scanner is not in the room.

**Note:** Refer to the disinfecting agent manufacturer's user manuals and data sheets for additional information and instructions for use.

To reduce the risk of cross-contamination, it is mandatory to:

- Thoroughly clean and disinfect the wand, cradle, and other system components, as described in the following sections.
- Attach a new sleeve before each patient session, as described in [Applying a sleeve](#).
- Dispose of the sleeve after each patient and in accordance with standard operating procedures or local regulations for the disposal of contaminated medical waste.
- Wear gloves when using the touch-screen.
- Remove and replace gloves after each patient procedure.
- Discard torn, contaminated, or used gloves.

### 11.1 Handling the wand and cable

The wand contains delicate components and should be handled with care.

When not in use, the wand should be kept in its cradle, with the optical surface facing the cradle, and with the dark protective sleeve attached.

Between patients, undo any twists and knots in the wand cable in order to relieve all tension.

## 11.2 Cleaning and disinfecting the wand

The iTero wand requires the procedures in the following sections for cleaning and disinfection.

These procedures must be carried out:

- After the scanner assembly, before first-time use
- Immediately after each patient

You must follow all the cleaning and disinfecting steps below to ensure that the wand is properly reprocessed and ready for use.

### 11.2.1 Preparation before cleaning and disinfection

1. To avoid false activation of the wand during the cleaning and disinfection procedures, make sure to exit a scan completely by sending the scan or by going back to the home screen.
2. Remove the sleeve as described in [Removing the sleeve](#), making sure not to touch the optical surface of the wand.

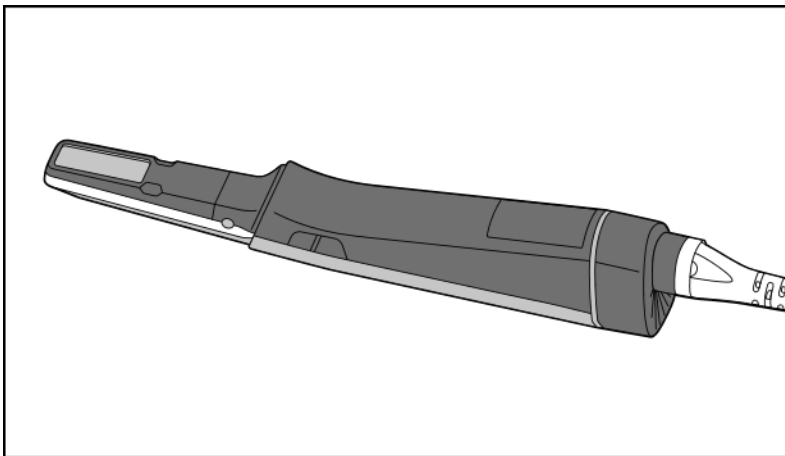

Figure 220: Wand without a sleeve

3. Visually inspect the wand for any noticeable damage, for example, deterioration such as corrosion, discoloration, pitting, or cracks.

If damage is found, see the **Scanner warnings** section of the [Safety instructions](#).

4. Prepare the following:
  - Required cleaning and disinfecting materials:
    - CaviWipes1 (or, for a list of alternative materials and the required contact time, see [Approved cleaning and disinfecting materials](#))
    - 70% isopropyl alcohol (IPA)
    - Dry lint-free wipes
    - Soft bristle brush (e.g. the smaller end of a Healthmark Trumpet Valve Brush 1mm diameter, Cat # 3770 or equivalent)
  - Personal Protective Equipment (PPE) and work environment
    - Please follow the cleaning and disinfection material manufacturers' instructions

**Note:** Replace cleaning and disinfection materials (brushes/wipes) if visibly damaged or soiled.

**Before starting the cleaning and disinfection procedure, put on your PPE.**

### 11.2.2 Wand cleaning and disinfection

Before cleaning and disinfecting the wand, ensure that the sleeve has been removed.

#### Cleaning

1. Using CaviWipes1, remove any gross contaminants on the wand body and wand tip, including the optical surface, for a minimum of one (1) minute.

**Note:** If you are using an alternative disinfectant, see the following sections for the required contact time.

- **Outside Australia:** See [Approved cleaning and disinfection materials \(not relevant for Australia\)](#)
- **Australia:** See [Approved cleaning and disinfection materials \(Australia only\)](#)

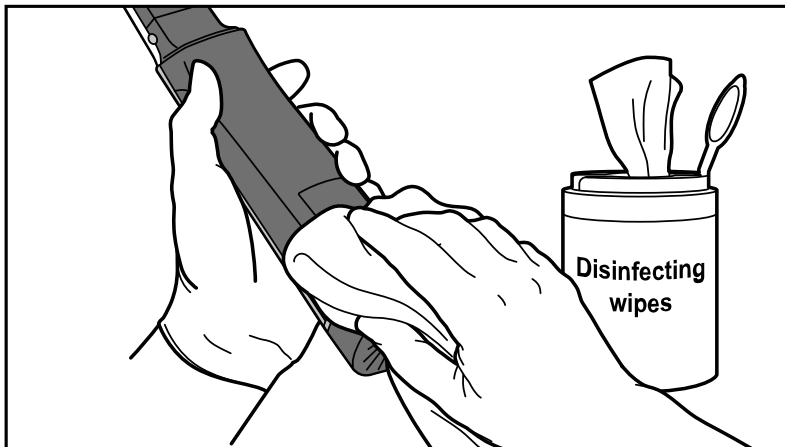

Figure 221: Remove gross contaminants using CaviWipes1

2. Using the soft bristle brush, remove any remaining marks and stains on the wand body and wand tip, paying special attention to the grooves, indents, joints, vents, etc. Brush until visibly clean.

**Note:** Do not use the brush on the optical surface to avoid damage to the wand.

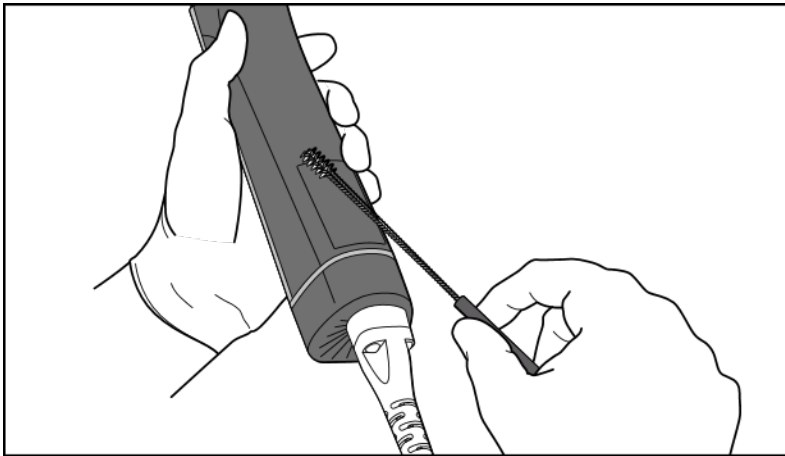

Figure 222: Remove marks and stains using a soft bristle brush

3. Using CaviWipes1, remove any remaining contaminants on the wand body and wand tip.
4. Visually inspect the device in a well-lit area to ensure all surfaces are visibly clean.
5. If required, repeat step 3 until no visual contamination is observed.

#### **Disinfection** (intermediate-level disinfection)

**Note:** Use multiple fresh wipes to keep the wand's surfaces wet, paying special attention to the hard to disinfect areas (i.e., notches, seams, sleeve snappers, and buttons).

Ensure the wand surfaces remain wet for the full one (1) minute contact time.

1. Using CaviWipes1, thoroughly dampen all external surfaces of the wand body and wand tip, including the optical surface, and ensure they remain wet for a minimum of one (1) minute.
2. Using lint-free wipe(s) wetted (but not dripping) with 70% Isopropyl Alcohol (IPA), thoroughly wipe the wand body and tip, *excluding* the optical surface of the wand, one (1) time.

- Using a *new* lint-free wipe wetted (but not dripping) with 70% Isopropyl Alcohol (IPA), thoroughly wipe the *optical surface* of the wand one (1) time until visibly clean.

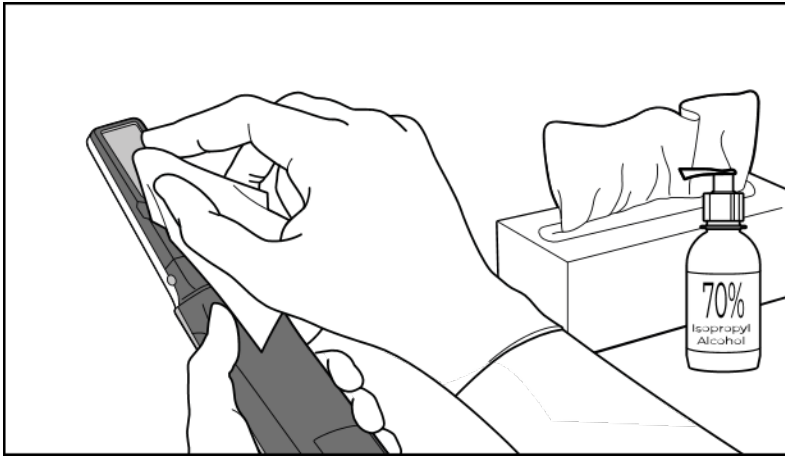

Figure 223: Wipe the optical surface of the wand with IPA

- Wait until the optical surface dries (approximately 5–10 seconds).
- Remove any residue from the optical surface using a dry lint-free wipe.
- Visually inspect the optical surface for any noticeable damage, for example, scratches, stains, murkiness, or opaqueness.

If damage is found, see the **Scanner warnings** section of the [Safety instructions](#).

### 11.2.3 Drying – wand body

Air-dry the disinfected wand at room temperature.

### 11.2.4 Storage and maintenance

- Visually inspect the wand for any noticeable damage, for example, deterioration such as corrosion, discoloration, pitting, or cracks. Pay special attention to the optical surface, making sure it remains clean.

If damage is found, see the **Scanner warnings** section of the [Safety instructions](#).

- Place the dark protective sleeve on the wand tip.
- Place the wand in the cleaned and disinfected cradle, as described below.

## 11.3 Cleaning and disinfecting the cradle

The wand cradle requires the procedures in the following sections for cleaning and disinfection.

These procedures must be carried out:

- After the scanner assembly, before first-time use
- Immediately after each patient

You must follow all the cleaning and disinfecting steps below to ensure that the cradle is properly reprocessed and ready for use.

### 11.3.1 Preparation before cleaning and disinfection

1. Visually inspect the cradle for any noticeable damage, for example, deterioration such as discoloration, pitting, or cracks.

If damage is found, see the **Scanner warnings** section of the [Safety instructions](#).

2. Prepare the following:

- Required cleaning and disinfecting materials:
  - CaviWipes1 (or, for a list of alternative materials and the required contact time, see [Approved cleaning and disinfecting materials](#))
  - Soft bristle brush (e.g. the smaller end of a Healthmark Trumpet Valve Brush 1mm diameter, Cat # 3770 or equivalent)
- PPE and work environment
  - Please follow the cleaning and disinfecting material manufacturers' instructions.

**Note:** Replace cleaning and disinfection materials (brushes/wipes) if visibly damaged or soiled.

**Before starting the cleaning and disinfection procedure, put on your PPE.**

### 11.3.2 Cradle cleaning and disinfection

#### Cleaning

1. Using CaviWipes1, remove any gross contaminants on the cradle for a minimum of one (1) minute.

**Note:** If you are using an alternative disinfectant, please see [Approved cleaning and disinfecting materials](#) for the required contact time.

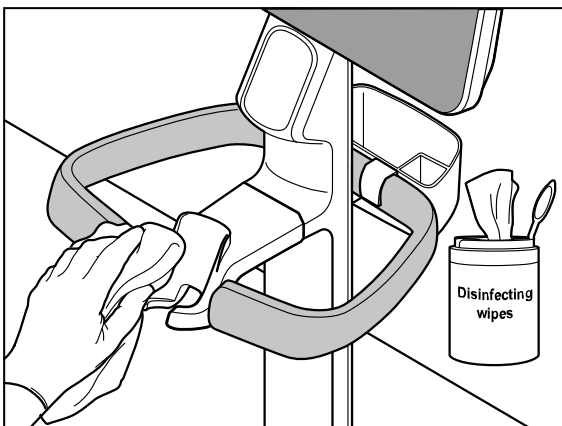

Figure 224: Wiping the iTero Lumina cart-configuration cradle

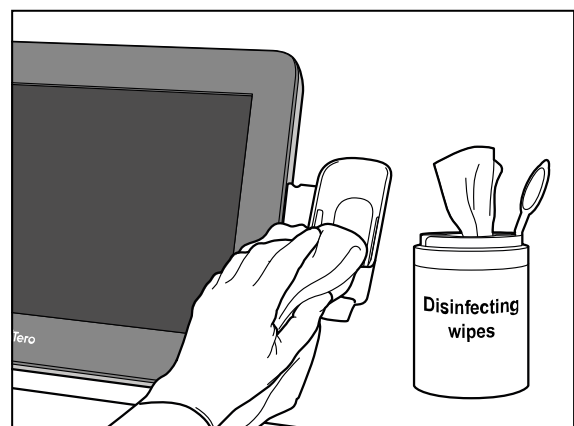

Figure 225: Wiping the iTero Lumina mobile-configuration cradle

- Using the soft bristle brush, remove any remaining marks and stains on the cradle, paying special attention to the grooves, indents, joints, etc.

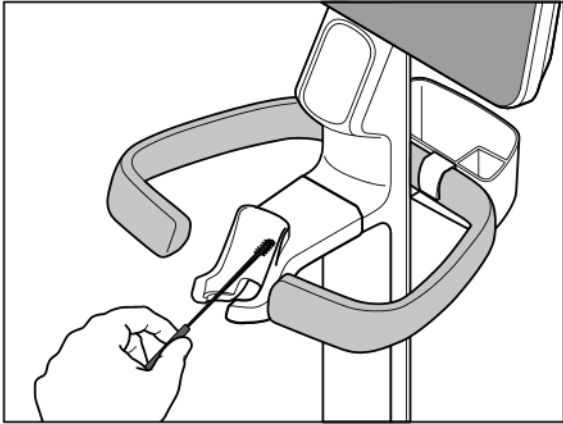

Figure 226: Brushing the iTero Lumina cart-configuration cradle

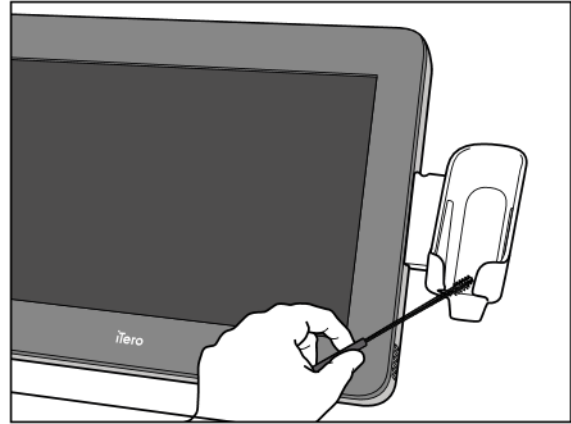

Figure 227: Brushing the iTero Lumina mobile-configuration cradle

- Using CaviWipes1, remove any remaining contaminants on the cradle.
- Visually inspect the cradle in a well-lit area to ensure all surfaces are visibly clean.
- If required, repeat step 3 until no visual contamination is observed.

#### Disinfection (intermediate-level disinfection)

- Using CaviWipes1, thoroughly dampen all external surfaces of the cradle and ensure they remain wet for a minimum of one (1) minute.

**Note:** Use multiple fresh wipes, as necessary, to keep the cradle surfaces wet for the full one (1) minute contact time.

### 11.3.3 Drying – cradle

Air-dry the disinfected cradle at room temperature.

### 11.3.4 Storage and maintenance

Visually inspect the cradle for any noticeable damage, for example, deterioration such as discoloration, pitting, or cracks.

If damage is found, see the **Scanner warnings** section of the [Safety instructions](#).

## 11.4 Cleaning and disinfecting the scanner touch screen and the main handle

The scanner screen and main handle must be cleaned and disinfected (low-level disinfection) immediately after each patient, as follows:

1. Clean and disinfect all outer surfaces using approved disinfectant wipes, or approved disinfectant liquid with a clean lint-free wipe, and follow the manufacturer's instructions. For a list of approved materials, see [Approved cleaning and disinfecting materials](#).
2. Remove any residual liquid disinfectant with a clean lint-free wipe.
3. Visually inspect the scanner screen and the main handle in a well-lit area to ensure all surfaces are visibly clean. Repeat the cleaning procedure according to the manufacturer's instructions until no visual contamination is observed.
4. Visually inspect the scanner screen for any noticeable damage, for example, scratches or stains, and confirm the responsiveness of the touch screen.

If damage is found, see the **Scanner warnings** section of the [Safety instructions](#).

## 11.5 General cleaning and disinfection comments

All scanner parts and reusable accessories not outlined above should be thoroughly cleaned according to standard operating procedures or local regulations.

**Note:** Refer to the disinfecting agent manufacturer's user manuals and data sheets for additional information and instructions for use.

In addition to the processes described above, national standards and regulatory requirements may apply.

iTero scanners are typically cleaned and disinfected in the use environment.

## 11.6 Approved cleaning and disinfecting materials

### 11.6.1 Approved cleaning and disinfection materials (not relevant for Australia)

The following table lists the Align-recommended cleaning and disinfecting materials, as well as the minimum contact time required.

If you are using a liquid disinfectant, soak a clean, sterile, lint-free wipe in the liquid and squeeze until moist, and then follow the cleaning and disinfection instructions described in this document.

When following the cleaning and disinfection procedure detailed in this manual, please also refer to the disinfecting agent manufacturer's user manuals and data sheets for additional information and instructions for use, including recommended contact times.

Material	Active Ingredient	Contact time (minutes)
CaviWipes1/CaviCide1	Quats-alcohol (Quaternary Ammonium Chloride)	1
CaviWipes/CaviCide	Quats-alcohol (Quaternary Ammonium Chloride)	3
Clinell Universal Range Wipes	0.5% Didecyldimethylammonium Chloride (DDAC)	2

**Note:** If the recommended alternative disinfectants are not available in your region, consult your local supplier of disinfecting materials for equivalent products in your region. Equivalent products must meet local regulatory requirements, have the same active ingredients, and in addition, must be capable of intermediate-level disinfection, including being able to disinfect against at least Hepatitis and Tuberculosis.

### 11.6.2 Approved cleaning and disinfection materials (Australia only)

The following table lists the Align-recommended active ingredients and concentration levels for cleaning and disinfecting materials.

	Active ingredients and concentration levels
1	0.76% Didecyldimethylammonium Chloride (DDAC), 7.5% Ethanol, and 15% Isopropanol

Consult your local supplier of disinfecting materials for approved cleaning and disinfecting materials in your region. Cleaning and disinfecting products must meet local regulatory requirements, have the above-mentioned active ingredients and concentration levels, and in addition, must be capable of intermediate-level disinfection, including being able to disinfect against at least Hepatitis and Tuberculosis.

If you are using a liquid disinfectant, soak a clean, sterile, lint-free wipe in the liquid and squeeze until moist, and then follow the cleaning and disinfection instructions described in this document.

When following the cleaning and disinfection procedure detailed in this manual, please also refer to the disinfecting agent manufacturer's user manuals and data sheets for additional information and instructions for use, including recommended contact times.

## 11.7 Disposal instructions

Do not dispose of this product in domestic or municipal waste. This device contains WEEE materials.

Contact your local Customer Support to securely decommission the system by sanitizing the product of sensitive, confidential, and proprietary data and software, and to arrange scanner collection.

Dispose of batteries in accordance with local environmental laws and guidelines.

Dispose of sleeves according to standard operating procedures or local regulations for the disposal of contaminated medical waste.

## Appendix A: Clinic LAN network guidelines

### A.1 Introduction

The scanner is capable of connecting to the wireless LAN in order to support the file transfer to and from the iTero cloud. Connection to other wireless devices is not supported.

Below are some helpful guidelines for the best Wi-Fi connection.

#### Levels of Wi-Fi Internet Connectivity



Excellent

>-50 dBm



Good

-50 to -60 dBm



Fair

-60 to -70 dBm



Weak

<-70 dBm

**IMPORTANT:** In order to achieve the best performance of your iTero scanner, ensure that the Wi-Fi signal strength is Excellent or at least Good.

### A.2 Preparations

- The required modem/router should be configured with the WPA2 security standard, including a password.
- Ensure that your IT professional staff will be available when the scanner installation is planned to take place.
- Make sure that the Wi-Fi SSID credentials are available: Login & password.
- The minimum Wi-Fi strength signal for the system should display at least three lines, as shown above.
- Following are some suggestions for the office IT personnel, regarding what should be considered in order to prevent issues such as access or connectivity to/with the iTero scanner:
- Hostname recommendations related to Align services listening to port 443, as described in [Align hostname recommendations](#).
- Do not prevent FTP communication since the scanner sends specific file types (.3ds and .3dc/.3dm).
- Disable any proxy clients for data communication through TCP/IP.
- Do not add the scanner to any domain group.
- Do not run any group policy on the scanner as it may disrupt its proper functioning.

### A.3 Router guidelines

Minimum standards: 802.11N / 802.11AC

#### A.4 Internet connection guidelines

In order to achieve the best performance of your iTero scanner, ensure that the internet connection upload speed is at least 1Mbps per scanner. Also, note that any additional devices connected to the internet in parallel to the scanner may affect the scanner's performance.

#### A.5 Firewall

Open the following port (in case of a firewall):

- 443 - HTTPS - TCP

#### A.6 Wi-Fi tips

Wi-Fi routers allow you to access the internet system using a Wi-Fi connection from essentially any place within the functional range of the wireless network. Nevertheless, the number, depth, and position of walls, ceilings, or additional partitions that the wireless signals must travel through may limit the range and strength of the signal. Normal signals vary, depending on the material types and background RF (radio frequency) noise in your home or business.

- Be sure to have a minimal number of walls and ceilings between the router and other network devices. Each barrier can reduce the adapter's range by 1-3 meters (3-9 feet).
- Be sure to have a straight line, free of any partition, between network devices. Even a wall that seems rather thin can block a signal of 1 meter (3 feet) if the wall angle is shifted by only 2 degrees. To achieve the best reception, place all the devices so that the Wi-Fi signal travels straight through a wall or partition (instead of at an angle).
- Construction materials make a difference. A solid metal door, or aluminum nails, can be very dense and may have an adverse effect on a Wi-Fi signal. Try to position access points, wireless routers, and computers so that the signal travels through drywalls or open doorways. Materials and objects such as glass, steel, metal, walls with insulation, water tanks (aquariums), mirrors, file cabinets, brick, and concrete may reduce the wireless signal.
- Keep the scanner away (at least 3-6 feet or 1-2 meters) from electrical devices or appliances that generate RF noise.
- If you are using 2.4GHz cordless phones or X-10 (wireless products such as ceiling fans, remote lights, and home security systems), the wireless connection may be severely degraded or entirely drop. The base of many wireless devices transmits an RF signal, even if the device is not in use. Position any other wireless devices as far as possible from the scanner and router.
- In your area, there may be more than one active wireless network. Each network uses one or more channels. If the channel is near your system channels, the communication may gradually decline. Ask your IT department to check this, and if required, change the channel numbers used by your network.

## A.7 Align hostname recommendations

Align constantly improves its products and services, and can therefore commit to a Hostname, rather than a specific IP address.

The following list of hostnames was created to provide Align's scanners the proper operation functions, in order to be able to utilize all the advanced capabilities of the scanner performance.

Align hostname recommendation:

Hostname	Port	Service
Mycadent.com	TCP/443	HTTPS
Myaligntech.com	TCP/443	HTTPS
Export.mycadent.com	TCP/443	HTTPS
Cbserver.mycadent.com	TCP/443	HTTPS
Matstore3.invisalign.com	TCP/443	HTTPS
Matstoresg.invisalign.com	TCP/443	HTTPS
Matstorechn.invisalign.com.cn – Required only for devices located in China.	TCP/443	HTTPS
Baidu.com – Required only for devices located in China	TCP/443	HTTPS
cn.bing.com – Required only for devices located in China	TCP/443	HTTPS
qq.com – Required only for devices located in China	TCP/443	HTTPS
export.myitero.cn – Required only for devices located in China	TCP/443	HTTPS
AWS IP range - Amazon global CDN service - IP address range varies depending on the location of the scanner.	TCP/443, TCP/9243	HTTPS
cloud.myitero.com	TCP/443	HTTPS
itero-scanner-speed-test-prd.s3-accelerate.amazonaws.com	TCP/443	HTTPS
alignapi.aligntech.com	TCP/443	HTTPS
google.com	TCP/443	HTTPS
microsoft.com	TCP/443	HTTPS
yahoo.com	TCP/443	HTTPS
iterosec.aligntech.com	TCP/443	HTTPS
storage.cloud.aligntech.com	TCP/443	HTTPS
*.teamviewer.com	TCP/443	HTTPS

Hostname	Port	Service
*.sentinelone.net	TCP/443	HTTPS
iterocloud.com	TCP/443	HTTPS
itero.com	TCP/443	HTTPS
storagy-akamai-production-us.s3.amazonaws.com/iTero	TCP/443	HTTPS

## Appendix B: EMC declaration

### B.1 EMC declaration – iTero Lumina

<b>IEC 60601-1-2 Edition 4.1 (2014 + A1: 2020)/EN 60601-1-2 (2015/A1: 2021)</b>	Medical electrical equipment; Part 1-2: General requirements for basic safety and essential performance - Collateral Standard: Electromagnetic disturbances - Requirements and tests.
<b>CFR 47 FCC</b>	Rules and Regulations: Part 15. Radio frequency devices. Subpart B: Unintentional radiators (2020).
<b>ETSI EN 301 489-1, ETSI EN 301 489-17</b>	Electromagnetic Compatibility (EMC) standard for radio equipment and services.
<b>Environment for intended use</b>	Professional Healthcare and Home Healthcare Facility Environment.

The device does not have Essential Performance according to IEC 60601-1 definition.

This device complies with Part 15 of FCC Rules and its operation is subject to the following two conditions:

- This device may not cause harmful Electromagnetic (EM) interference.
- This device must accept any EM interference received, including any that may cause undesired operation.

Modifications to the device that are not expressly approved by the manufacturer may void your authority to operate the device under FCC Rules.

#### Notes:

- “Harmful interference” is defined in 47 CFR §2.122 by the FCC as follows: Interference which endangers the functioning of a radionavigation service or of other safety services or seriously degrades, obstructs, or repeatedly interrupts a radio communication service operating in accordance with the [ITU] Radio Regulations.
- Interference may occur in the vicinity of the device.
- Due to electromagnetic disturbance, in some cases, the image may disappear and a non-communication message will appear on the touch screen. The scanner will return to operation mode after user intervention or auto-recovery.

The following is a summary of the EMC test results for iTero Lumina scanners:

Test	Standard	Class / Severity level	Test results
<b>Emission</b> (IEC 60601-1-2 / EN 60601-1-2 section 7.1 & 7.2)			
Conducted emission Freq. range: 150 kHz - 30 MHz	CISPR 11 / EN 55011	Group 1 Class B: – AC mains (240 V, 230 V, 120 V, 100 V @50Hz; 220 V @ 60 Hz)	Complies
Radiated emission Freq. range: 30 - 1000 MHz	CISPR 11 / EN 55011	Group 1 Class B	Complies
Harmonic current emission test	IEC 61000-3-2 / EN 61000-3-2	AC mains (230/240 V @ 50 Hz & 220 V @ 60 Hz)	Complies
Voltage changes, Voltage fluctuations and Flicker test	IEC 61000-3-3 / EN 61000-3-3	AC mains (230 V @ 50 Hz & 220 V @ 50 Hz)	Complies
<b>Immunity</b> (IEC 60601-1-2 / EN 60601-1-2 sections 8.9 and 8.10)			
Immunity from Electrostatic discharge (ESD)	IEC 61000-4-2 / EN 61000-4-2	8 kV contact discharges & 15 kV air discharges (AC mode (230 V @ 50 Hz & 220 V @ 60 Hz) & Battery mode)	Complies
Immunity from radiated electromagnetic fields	IEC 61000-4-3 / EN 61000-4-3	10.0 V/m; 80 MHz ÷ 2.7 GHz, 80% AM, 1 kHz  (AC mode ((230 V @ 50 Hz & 220 V @ 60 Hz) & Battery mode)	Complies
Immunity from Proximity field from wireless communications equipment	IEC 61000-4-3 / EN 61000-4-3	List of frequencies, from 9 V/m up to 28 V/m, PM (18 Hz or 217 Hz), FM 1 kHz	Complies
Immunity from Electrical Fast transient (EFT)	IEC 61000-4-4 / EN 61000-4-4	± 2.0 kV on AC mains (230 V @ 50 Hz & 220 V @ 60 Hz); Tr/Th – 5/50 ns, 100 kHz	Complies
Immunity from Surge	IEC 61000-4-5 / EN 61000-4-5	±2.0 CM / ±1.0 kV DM on AC mains (230 V @ 50 Hz & 220 V @ 60 Hz); Tr/Th – 1.2/50 (8/20) µs	Complies

Test	Standard	Class / Severity level	Test results
Immunity from conducted disturbances induced by radio-frequency fields	IEC 61000-4-6 / EN 61000-4-6	6.0 VRMS on AC mains (230 V @ 50 Hz & 220 V @ 60 Hz) & Patient cable; 0.15÷ 80 MHz, 80% AM, 1 kHz	Complies
Immunity from power frequency magnetic field	IEC 61000-4-8 / EN 61000-4-8	30 A/m @ 50 Hz & 60 Hz (AC mode and Battery mode)	Complies
Immunity to proximity magnetic fields in the frequency range 9kHz to 13.56MHz	IEC 61000-4-39	8 A/m 30kHz CW 65 A/m @134.2kHz PM 2.1kHz 50% 7.5 A/m @13.56MHz PM 50kHz 50% (AC mode and Battery mode)	Complies
Immunity from voltage dips, short interruptions and voltage variations	IEC 61000-4-11 / EN 61000-4-11	On AC mode (240 V @ 50 Hz, 100 V @ 50 Hz): 0 % - 0.5 cycle & 1 cycle; 70% - 25 cycles; 0% - 250 cycles; On AC mode (220 V @ 60 Hz): 0 % - 0.5 cycle & 1 cycle; 70% - 30 cycles; 0% - 300 cycles	Complies
<b>Emission</b> (per ETSI EN 301 489-1, ETSI EN 301 489-17)			
Conducted emissions on mains terminals in freq. range 150 kHz - 30 MHz	ETSI EN 301 489-1; ETSI EN 301 489-17 / EN 55032	Group 1 Class B 230 VAC mains	Complies
Radiated emissions in freq. range 30 - 6000 MHz	ETSI EN 301 489-1; ETSI EN 301 489-17 / EN 55032	Class B	Complies
Harmonic current test	ETSI EN 301 489-1; ETSI EN 301 489-17 / EN 61000-3-2	230 VAC mains	Complies
Flicker tests	ETSI EN 301 489-1; EN 61000-3-3	230 VAC mains	Complies

Test	Standard	Class / Severity level	Test results
<b>Immunity</b> (per ETSI EN 301 489-1, ETSI EN 301 489-17)			
Immunity from Electrostatic discharge (ESD)	EN 61000-4-2	4 kV contact discharge 8 kV air discharge	Complies
Immunity from radiated electromagnetic fields	EN 61000-4-3	3.0 V/m, 80 MHz , 6.0 GHz, 80% AM, 1 kHz	Complies
Immunity from Electrical Fast transient (EFT)	EN 61000-4-4	AC mains: $\pm 1.0$ kV; Tr/Th – 5/50 ns, 5 kHz	Complies
Immunity from Surge	EN 61000-4-5	AC mains: $\pm 1.0$ kV DM / $\pm 2.0$ kV CM, Tr/Th – 1.2/50 (8/20) ms	Complies
Immunity from conducted disturbances induced by radio-frequency fields	EN 61000-4-6	AC mains: 3.0 VRMS; 0.15+80 MHz, 80% AM @ 1 kHz	Complies
Immunity from Voltage interruptions	EN 61000-4-11	AC mains: 0% - 0.5 cycle & 1 cycle; 70% - 25 cycles; 0% - 250 cycles	Complies

## B.2 Guidance and Align Technology’s Declaration – Electromagnetic Immunity – for iTero Lumina that is not Life-Supporting

The iTero Lumina intraoral scanner is intended for use in the electromagnetic environment specified below.

The customer or the user of the iTero Lumina should assure that it is used in such an environment.

Immunity Test	IEC 60601 Test Level	Compliance Level	Electromagnetic Environment – Guidance
Conducted RF IEC 61000-4-6	3 Vrms 150 kHz to 80 MHz	3 Vrms 150 kHz to 80 MHz	Portable and mobile RF communications equipment should be used no closer to any part of the iTero Lumina system, including cables, than the recommended separation distance calculated from the equation applicable to the frequency of the transmitter.
Radiated RF IEC 61000-4-3	3 V/m 80 MHz to 2,5 GHz	3 V/m 80 MHz to 2,5 GHz	<p>Recommended separation distance:</p> $d = \left[ \frac{3.5}{V1} \right] \sqrt{P}$ $d = \left[ \frac{3.5}{E1} \right] \sqrt{P} \quad 80 \text{ MHz to } 800 \text{ MHz}$ $d = \left[ \frac{7}{E1} \right] \sqrt{P} \quad 800 \text{ MHz to } 2.5 \text{ GHz}$ <p>where P is the maximum output power rating of the transmitter in watts (W) according to the transmitter manufacturer and d is the recommended separation distance in meters (m).</p> <p>Field strengths from fixed RF transmitters, as determined by an electromagnetic site survey, should be less than the compliance level in each frequency range.</p> <p>Interference may occur in the vicinity of equipment marked with the following symbol:</p>

**NOTE 1:** At 80 MHz and 800 MHz, the higher frequency range applies.

**NOTE 2:** These guidelines may not apply in all situations. Electromagnetic propagation is affected by absorption and reflection from structures, objects and people.

Field strengths from fixed transmitters, such as base stations for radio (cellular/cordless) telephones and land mobile radios, amateur radio, AM and FM radio broadcast and TV broadcast cannot be predicted theoretically with accuracy. To assess the electromagnetic environment due to fixed RF transmitters, an electromagnetic site survey

should be considered. If the measured field strength in the location in which the iTero Lumina system is used exceeds the applicable RF compliance level above, the iTero Lumina system should be observed to verify normal operation. If abnormal performance is observed, additional measures may be necessary, such as re-orienting or relocating the iTero Lumina system. Over the frequency range 150 kHz to 80 MHz, field strengths should be less than 3 V/m.

### B.3 Recommended Separation Distances Between Portable and Mobile RF Communications Equipment and the iTero Lumina Intraoral scanner that is not Life-Supporting

iTerO Lumina is intended for use in the electromagnetic environment in which radiated RF disturbances are controlled. The customer or the user of the iTero Lumina can help prevent electromagnetic interference by maintaining a minimum distance between portable and mobile RF communications equipment (transmitters) and the iTero Lumina system as recommended below, according to the maximum output power of the communications equipment.

<b>Recommended Separation Distances Between Portable and Mobile RF Communications and the Activator</b>			
<b>Rated maximum output power of transmitter Watts (W)</b>	<b>Separation distance according to frequency of transmitter Meters (m)</b>		
	<b>150 kHz to 80 MHz <math>d = 1.2 \sqrt{P}</math></b>	<b>80 MHz to 800 MHz <math>d = 1.2 \sqrt{P}</math></b>	<b>800 kHz to 2.7 GHz <math>d = 2.3 \sqrt{P}</math></b>
0.01	0.12	0.12	0.23
0.1	0.38	0.38	0.73
1	1.2	1.2	2.3
10	3.8	3.8	7.3
100	12	12	23

For transmitters rated at a maximum output power not listed above, the recommended separation distance  $d$  in meters (m) can be estimated using the equation applicable to the frequency of the transmitter, where  $P$  is the maximum output power rating of the transmitter in watts (W) according to the transmitter manufacturer.

**Note 1:** At 80 MHz and 800 MHz, the separation distance for the higher frequency range applies.

**Note 2:** These guidelines may not apply in all situations. Electromagnetic propagation is affected by absorption and reflection from structures, objects and people.

## Appendix C: FCC compliance information statement (SDoC)

We Align Technology Ltd. declare:

**Type of equipment:** The iTero Lumina scanner is capable of intraoral optical impressions for CAD/CAM of dental devices which also captures 2D color images.

**Brand name or trademark:** iTero Lumina

**Modular component used:** Qualcomm Atheros, FCC ID PPD-QCNFA364AH complies with FCC requirements according to Declaration of Conformity issued by Advantech Co., Ltd.

<b>TCB</b>		<b>GRANT OF EQUIPMENT AUTHORIZATION</b>		
		Certification Issued Under the Authority of the Federal Communications Commission By:		
		UL Verification Services Inc. (formerly UL CCS) 4773 Benicia Street Fremont, CA 94538		
Qualcomm Atheros, Inc. 1700 Technology Dr San Jose, CA 95110				
Attention: Paul Guckian , Vice President, Regulatory Engineering				
<b>NOT TRANSFERABLE</b>				
EQUIPMENT AUTHORIZATION is hereby issued to the named GRANTEE, and is VALID ONLY for the equipment identified hereon for use under the Commission's Rules and Regulations listed below.				
		<b>FCC IDENTIFIER:</b>	<b>PPD-QCNFA364AH</b>	
		<b>Name of Grantee:</b>	Qualcomm Atheros, Inc.	
		<b>Equipment Class:</b>	Digital Transmission System	
		<b>Notes:</b>	802.11a/b/g/n/ac + BT 4.1 M.2 2230 Type Card	
		<b>Modular Type:</b>	Single Modular	
<u>Grant Notes</u>	<u>FCC Rule Parts</u>	<u>Frequency Range (MHz)</u>	<u>Output Watts</u>	<u>Frequency Tolerance</u>
CC MO	15C	2402.0 - 2480.0	0.002	
CC MO	15C	2412.0 - 2472.0	0.51	
CC MO	15C	2422.0 - 2462.0	0.423	
CC MO	15C	5745.0 - 5825.0	0.371	
CC MO	15C	5755.0 - 5795.0	0.401	
CC MO	15C	5775.0 - 5775.0	0.569	

Output power listed is maximum combined conducted. This device supports 20 and 40MHz bandwidths for 2.4 GHz. This module may be installed only by the OEM or an OEM integrator. This transmitter has been approved for use in mobile RF exposure category configurations with the antenna(s) installed to provide a separation distance of at least 20 cm from all persons. Installation in portable devices is limited to the display section of a laptop or notebook PC where the antennas used during SAR testing (or equivalent antennas) are installed to provide at least 1cm distance from the base of the device and with an antenna-to-antenna separation distance of at least 3cm. The antennas used for this transmitter must not be collocated or operating in conjunction with any other antenna or transmitter within a host device, except in accordance with FCC multi-transmitter product procedures. Grantee must provide installation and operating instructions for complying with FCC multi-transmitter product procedures. Grantee must coordinate with OEM integrators to determine applicable host configurations to ensure RF exposure compliance, including simultaneous transmission. The highest reported SAR for body and simultaneous transmission conditions are 0.75 W/kg and 0.75 W/kg respectively.

CC: This device is certified pursuant to two different Part 15 rules sections.  
MO: This Multiple Input Multiple Output (MIMO) device was evaluated for multiple transmitted signals as indicated in the filing.

**Country of origin:** Israel

**Manufacturer:** Align Technology Ltd.

**Responsible Party name (IN USA):** Align Technology, Inc.

**Address:** 410 North Scottsdale Road, Suite 1300, Tempe, Arizona 85281 USA

**Telephone:** +1 (408) 470-1000

**Internet E-Mail:** iterosupport@aligntech.com

**Standards applied:**

- FCC Part 15B - For Unintentional radiators, performed by Align & Advantech
- FCC Part 15C for 2.4GHz band based on Qualcomm Atheros FCC ID PPD- QCNFA364AH, performed by Qualcomm Atheros
- FCC Part 15E for the 5GHz bands based on Qualcomm Atheros
- FCC ID PPD-QCNFA364AH, performed by Qualcomm Atheros

**Test reports / certificates issued by:**

- For Cart configuration, FCC Part 15 Subpart B - Test report number 7212312205 by SII.
- For Mobile configuration, FCC Part 15 Subpart B - Test report number 7212312202 by SII.
- For QUALCOMM module PPD-QCNFA364AH, FCC Part 15 Subpart C & E - Test report number RF150107E07B-1 by Bureau Veritas Consumer Product Service (H.K) Ltd. & Advantech DoC.

**Declaration of Conformity as issued by Advantech Co., Ltd. for panel PC model POC-ALG, which declares compliance with FCC requirements**

As manufacturer we declare under our sole of responsibility that the equipment follows the provisions of FCC Equipment Authorization Procedures under CERTIFICATION (47 CFR Section 2.907) and/or SUPPLIER'S DECLARATION OF CONFORMITY (47 CFR Section 2.906) as stated above.

Thus, is placed on the product .

## Appendix D: iTero Lumina Family product security whitepaper

*This whitepaper applies to the iTero Lumina Family of products. Depending on the version of the product you have procured, there may be differences in the features of the product. In addition, as this whitepaper was created at a point-in-time, changes may have occurred in Align Technology's product security practices to address evolution and maturation in the product security ecosystem.*

### **We understand the life sciences and healthcare industry and are addressing security across the organization.**

The threat of cyber-attacks to life sciences and healthcare products is constantly evolving. With this in mind, we proactively established a product security program that is focused on minimizing the security risk associated with our products, enabling us to be vigilant when facing emerging threats and to continuously improve our products.

We recognized the importance of incorporating security and privacy considerations by design and throughout our product lifecycle. To accomplish this, we established a cross-functional product security team, including representatives from engineering/ software development, security, legal/privacy, information technology, and quality.

### **We identify security risks using robust risk management processes.**

Align Technology is committed to addressing and minimizing security and privacy risks in the products that we design, develop, and maintain. We conduct in-depth assessments of our products with the goal of implementing appropriate risk mitigation measures at the outset of product development. Based on the risk level of the product, as well as the functionality of the product, the below methodology is applied.

- **Product Security Risk Management Program:** Align Technology conducted the program on the iTero Lumina™ Family of products. The methodology included planning and information gathering, scoping product ecosystem, performing a product security risk assessment, analyzing threats and vulnerabilities, assessing applicable security controls, and calculating the residual risk rating of any identified gaps. Security and privacy risks and controls considered as part of the assessment leverage industry leading practice security risk frameworks including, but not limited to, AAMI TIR57, and IEC/TR 80001-2-2.

- iTero has developed a Software Bill of Materials (SBOM) for iTero Lumina intraoral scanners to support our customers in effectively managing their assets, understanding the potential impact of identified vulnerabilities to the medical device system, and deploying countermeasures to maintain the device's safety and effectiveness. The SBOM will be provided to customers upon request.

### **Security and privacy features of the product.**

We aim to protect your data and patients through the design and maintenance of our products. As a result of our security- and privacy- by-design approach to product development, we have implemented the following non-exhaustive security controls in the iTero Lumina™ Family of products.

- **Data-at-rest is encrypted:** The scanners store Personally Identifiable Information (PII) in an encrypted database using AES-256 and intraoral scan images in an encrypted folder using Microsoft Encrypting File System (EFS). These encryption technologies help to prevent an attacker from capturing patient information stored on the scanner.
- **Data-in-transit is encrypted:** PII and intraoral scan images that are backed up to Align supporting systems is transmitted over supported transport layer security (TLS) encryption using trusted certificates. This helps to prevent an attacker from capturing patient information while in transit.
- **Anti-malware protections are in place:** The scanners come with pre- installed anti-virus and security tools that check for malicious files on the system. The anti-virus software definitions are updated frequently and scans are scheduled to run daily on the devices.

- **Remote maintenance is not possible without permission:** The devices use a commercially available off-the-shelf software to establish remote sessions. The software requires a User ID and password that must be supplied from the customer to the Align service personnel before the connection can take place.
- **Changes to the operating system and software are restricted:** The scanners implement a kiosk mode that prevents the user from making any unwanted changes to the operating system and software components.
- **User access management controls are enforced:** A user account and password is required to utilize the scanners. This helps protect access to the scanner and protects against unauthorized use.
- **Segregation of duties is applied:** The scanners offer the ability to register multiple user accounts with different roles to one scanner. There are roles for Doctor and Staff. This helps ensure the ability to track activities performed by individual users better protecting the device.
- **Create strong passwords and protect login credentials:** It is the customer's responsibility to set strong passwords with to access scanners and Align systems. The more characters it has with special characters, the stronger it is. Using a passphrase without personal information is one of the simplest ways to ensure that you have a strong password along with changing it every 90 days. Protect your username and password login credentials granting you access to scanners and Align systems by not sharing with anyone and working in a secure environment.
- **Apply segregation of duties and timely remove staff accounts when no longer needed:** If customer has multiple user accounts with access to the scanner, it is the customer's responsibility to register those multiple user accounts with the appropriate role of Doctor or Staff. This helps ensure the ability to track activities performed by individual users better protecting the device. Additionally, it is the customer's responsibility to remove user accounts when staff no longer require the access to the scanner.
- **Ensure current data backup and maintain latest software version:** It is the customer's responsibility to ensure scanners remain connected to Align systems to backup PII and intraoral scan images to Align supporting systems and are being restarted as requested to ensure latest scanner updates are being applied.

## Security and privacy responsibilities of the customer.

As part of our assessments, we have identified risks that are dependent on how the product is used. The securing of the products we provide to our customers is a shared responsibility among all stakeholders. Based on the assessment conducted on the iTero Lumina™ Family of products, we expect that you will take the following security steps to protect the product:

- **Physically secure the product and its operating environment:** It is the customer's responsibility to protect the physical security of the product and operate it in a secure manner.
  - The customer should disconnect the webcam when not in use for a training session.
  - The webcam lens should be covered when the webcam is not actively in use.
- **Securely operate and protect your network:** It is the customer's responsibility to secure your network through the use of network intrusion detection and prevention mechanisms, using adequately hardened network/application firewalls, and network segmentation, especially if exposed to public Internet. Additionally, dispose of data in an appropriate manner, complying with all local laws and regulations.

---

If you have any questions or concerns, please do not hesitate to contact Customer Support.

## Appendix E: System specifications

	<b>Cart configuration</b>	<b>Mobile configuration</b>
<b>Monitor</b>	21.5" Full HD (1920x1080) touch screen	15.6" Full HD (1920x1080) touch screen
<b>Wand</b>	<p>The wand emits the following radiation:</p> <ul style="list-style-type: none"> <li>• Blue laser, operating at 450 nm, pulsed illumination.</li> <li>• Green laser, operating at 520 nm, pulsed illumination.</li> </ul> <p>The laser illumination complies with EN 60825-1 Ed. 3.0 -2014 (Safety of laser products – Part 1: Equipment classification, requirements, and user's guide).</p> <ul style="list-style-type: none"> <li>• White LEDs, pulsed illumination complies with EN 62471:2006 (Photobiological safety of lamps and lamp systems).</li> </ul> <p>Wand operating voltage: 15VDC.</p> <p>Wand capturable distance: 0 to 25mm.</p> <p>Wand maximum external surface temperature:</p> <ul style="list-style-type: none"> <li>• Body: 48°C (118.4°F)</li> <li>• Tip (applied part): 43°C (109.4°F)</li> </ul> <p><b>Note:</b> The temperature of the wand tip without a sleeve can reach 51°C (123.8°F).</p>	
<b>Wireless LAN</b>	<p>A LAN card provides local network communications with wireless connectivity</p> <ul style="list-style-type: none"> <li>• 2.4GHz, 5GHz</li> <li>• 802.11ac</li> </ul>	
<b>Security</b>	<p>See <a href="#">iTero Lumina Family product security whitepaper</a>.</p>	
	<b>Cart configuration</b>	<b>Mobile configuration</b>
<b>Operating Power</b>	100-240 VAC- 50/60 Hz- 300 VA (max)	100-240 VAC- 50/60 Hz- 250 VA (max)
<b>Operating environmental conditions</b>		
• <b>Temperature</b>	18°C to 26°C / 64.4°F to 78.8°F	
• <b>Relative Humidity</b>	40% to 70% (non condensing)	
• <b>Pressure</b>	430mmHg to 771mmHg (57kPa to 103kPa)	
• <b>Altitude</b>	-400 feet to 12,000 feet	

**Transportation environmental conditions**

- **Temperature** -29°C to 60°C (-20.2°F to 140°F)
- **Relative Humidity** 30% to 90% (non condensing)
- **Pressure** 430mmHg to 760mmHg (57kPa to 101kPa)
- **Altitude** -400 feet to 15,000 feet

**Storage environmental conditions**

- **Temperature** -5°C to 50°C / 23°F to 122°F
- **Relative Humidity** 30% to 90% (non condensing)
- **Pressure** 430mmHg to 771mmHg (57kPa to 103kPa)
- **Altitude** -400 feet to 12,000 feet

**Physical properties**

- **Wand (maximum dimensions)**
  - Length: 248.2 mm (~9.8 in)
  - Width: 43.9 mm (~1.7 in)
  - Depth: 39.2 mm (~1.5 in)

	<b>Cart configuration</b>	<b>Mobile configuration</b>
• <b>iTero Full HD touch-screen computing unit</b>	<ul style="list-style-type: none"> <li>• Height: 356 mm (~14 in)</li> <li>• Width: 544 mm (~21.5 in)</li> <li>• Depth: 60.5 mm (~2.3 in)</li> </ul>	<ul style="list-style-type: none"> <li>• Height: 275 mm (~10.8 in)</li> <li>• Width: 419 mm (~16.5 in)</li> <li>• Depth: 41.5 mm (~1.6 in)</li> </ul>
	<b>Cart configuration</b>	<b>Mobile configuration</b>
• <b>Wheel stand</b>	<ul style="list-style-type: none"> <li>• Height: 1279 mm (~50.3 in)</li> <li>• Width: 544 mm (~21.4 in)</li> <li>• Depth: 562 mm (~22.1 in)</li> </ul>	N/A
	<b>Cart configuration</b>	<b>Mobile configuration</b>
• <b>Cable length</b>	Wand cable: 1.8 m typical Power cable: 3000 mm	Wand cable: 1.8 m typical Power cable: 1600 mm or 3000 mm
	<b>Cart configuration</b>	<b>Mobile configuration</b>
• <b>Net Weight</b>	Computing unit: 10.5 kg (~23.1 lbs.) Wand: ~0.26 kg (~0.57 lbs.) without the cable Wheel stand: ~12.5 kg (~27.5 lbs.)	Computing unit with cradle and wand: ~5.5 kg (~12.0 lbs.) System packed in trolley: ~11 kg (~24.0 lbs.) Wand: ~0.26 kg (~0.57 lbs.) without the cable

<b>CPU Specifications</b>	Intel® Core™ i7
<b>GPU Specifications</b>	Nvidia
<b>Battery</b>	<p>Integrated battery for uninterrupted scanning and ease in office portability without plugging in or rebooting, providing:</p> <ul style="list-style-type: none"> <li>• At least 30 minutes of active scanning (cart configuration) and 10 minutes (mobile configuration)</li> <li>• &lt;2.5 hours for a full recharge</li> </ul>
<b>Scanner and wand cross-contamination protection</b>	<ul style="list-style-type: none"> <li>• Single-use, disposable sleeves</li> </ul>
<b>Sleeve handling instructions</b>	<ul style="list-style-type: none"> <li>• Keep away from sunlight.</li> <li>• Do not reuse.</li> <li>• Keep dry.</li> </ul>
<b>Accessible ports</b>	<ul style="list-style-type: none"> <li>• USB type A port intended to be connected only to an Align-provided webcam for training purposes.</li> <li>• USB type C port is not in use and should not be connected to any external devices.</li> </ul>
<b>Scanning technology</b>	iTero Multi-Direct Capture™ technology
<b>Scanning properties</b>	<ul style="list-style-type: none"> <li>• Enables hovering, while also allowing a scan to be performed at 0 mm.</li> <li>• No field calibration needed.</li> <li>• Flexible scanning protocol (start anywhere, automated segment stitching).</li> <li>• Automated heating of the tip to avoid fogging of the lens.</li> <li>• Illumination: White LEDs illumination meets Risk Group 1 (Low-Risk) according to EN 62471, Photobiological safety of lamps and lamp systems. Laser illumination is classified as a class 1 laser product per IEC 60825-1, Safety of laser products - Equipment classification and requirements.</li> <li>• Global accuracy – Per ADA Standard No. 132 Scanning Accuracy of Dental Chairside and Laboratory CAD/CAM Systems, as measured on test specimen three – Long Distance specimen: <ul style="list-style-type: none"> <li>◦ Absolute mean measurement error: <math>\leq 0.25\%</math></li> <li>◦ Absolute STD of measurement error: <math>\leq 0.25\%</math></li> </ul> </li> <li>• Local accuracy – Per ADA Standard No. 132 Scanning Accuracy of Dental Chairside and Laboratory CAD/CAM Systems, as measured on Test specimens one and two – Crown and Inlay specimens: <ul style="list-style-type: none"> <li>◦ Absolute mean measurement error <math>\leq 1\%</math></li> <li>◦ Absolute STD of measurement error <math>\leq 1\%</math></li> </ul> </li> </ul>

**Scan time**

- Orthodontic scans: Full mouth can be completed in as little as 60 seconds.
- Restorative scans: Full mouth can be completed in 120 seconds plus 30 seconds for each prep.

**Cloud storage**

Data can be stored and accessed on the web using cloud storage and the MyiTero web portal.

**Service lifetime**

5 years





Align Technology, Inc.  
410 North Scottsdale Road,  
Suite 1300, Tempe,  
Arizona 85281  
USA

© 2025 Align Technology, Inc. All rights reserved. Align, Invisalign, iTero, iTero Lumina, among others, are trademarks and/or service marks of Align Technology, Inc. or one of its subsidiaries or affiliated companies and may be registered in the U.S. and/or other countries. 216257 Rev. F

